

# VL/I-486SV2G, VL/I-486SV2GX4

*VL & ISA Bus, 486 Green PC Mainboard*

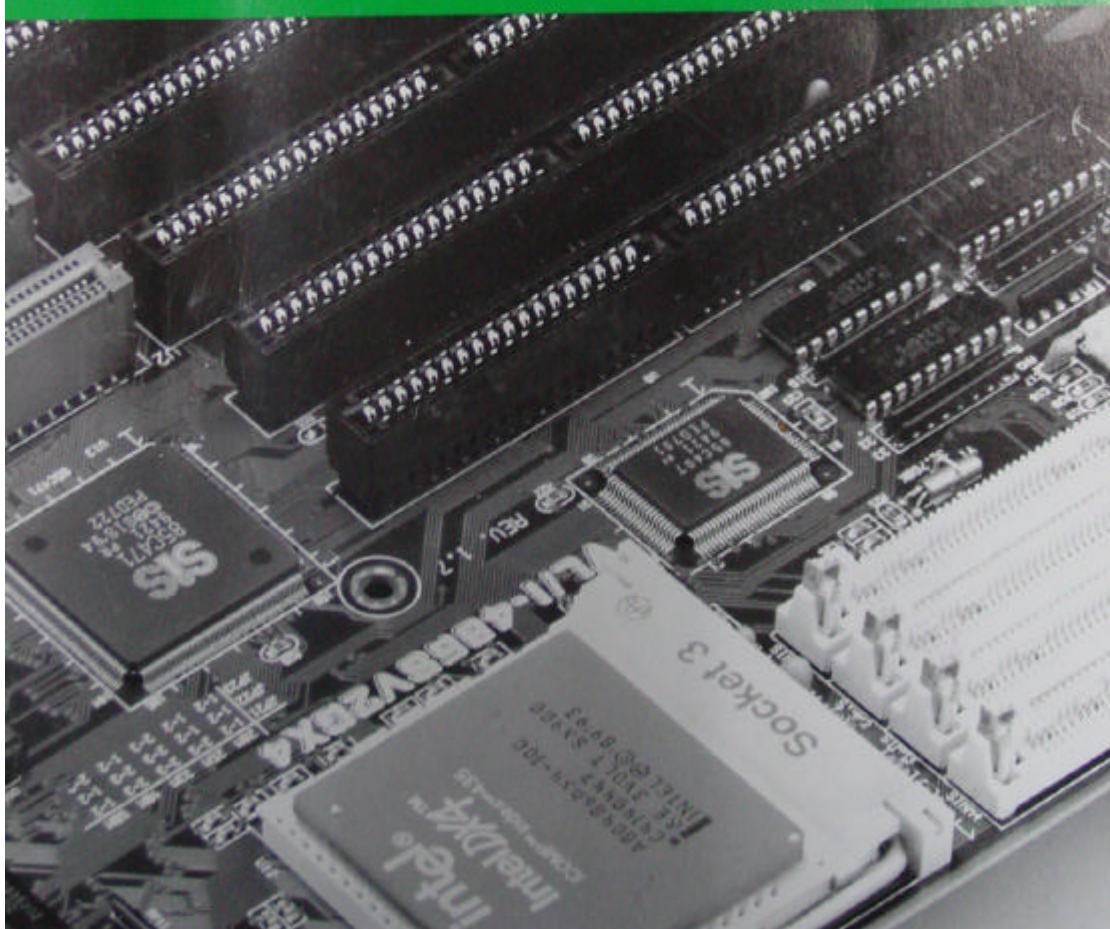

## Technical Summary

This section summarizes the mainboard's specifications. The first part is a summary of the jumper settings, followed by cache, connector and other general specifications.

### *Jumper Setting Summary*

This section lists all the jumper settings on the mainboard. They are mainly listed in numerical order for convenience. There are no jumpers for numbers missing from the sequence. Where jumpers are associated with each other they are listed together. The small diagrams of the mainboard indicate the positions of jumpers on the board. The number pairs listed in the settings indicate which pins of the jumper to short to establish the setting.

#### **Battery Source Selection: JP1**

This jumper selects between Internal (On-board) and External (not on-board) battery support for the Setup Utility configuration record stored in CMOS memory on the board. The default setting is for the on-board Lithium battery. If you want to connect a battery to the External Battery connector, use the other setting.

<i>JP1</i>	
<b>Internal (default)</b>	1&2
<b>External</b>	2&3



**Internal  
(default)**



**External**

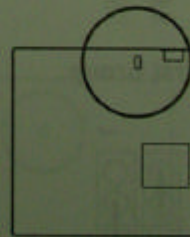

**SMI Out Connector: JP2-4**

These are a connector, not jumpers. They connect to a special lead from a "green" power supply. There are no caps for them because they are not jumper switches.

**Hardware Trap Settings: JP5 & 6**

These two jumpers set together indicate to the chipset the type of CPU installed.

CPU	JP5	JP6
486SX, DX, DX2	1&2	2&3
SL 486SX, DX, DX2, DX4		
Cyrix S(2), DX(2), DX2-V <i>5x86</i>	2&3	1&2
AMD486D (S) XL/L2		
P24D, P24T, P24CT	1&2	1&2
AMD486D (S) X PLUS		

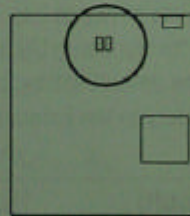
**First Group****Second Group****Third Group**

**On-board PS/2 Mouse Selection: JP7**

This jumper Enables/Disables the PS/2 mouse connector on the board for a lead to a case-mounted mouse port.

	JP7
<b>Enable (default)</b>	1&2
<b>Disable</b>	2&3

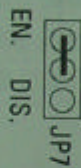

**Enable**

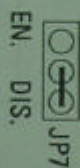

**Disable**

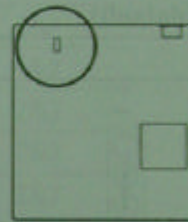

**DMA Selection: JP8**

This jumper is factory set, don't change it.

**Video Display Type: JP9**

The default setting is for all display systems (monitor & video card) except CGA.

	JP9
<b>Mono/VGA (default)</b>	1&2
<b>CGA</b>	2&3



**Mono/VGA**



**CGA**



**SMI Switch Control: JP10**

This jumper Enables/Disables the JP30 SMI Suspend Switch connector on the board for a lead to a case-mounted Suspend switch.

*JP10*

<b>Enable (default)</b>	2&3
<b>Disable</b>	1&2



**Enable**

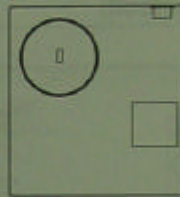

**Disable**

**Cyrix/Intel CPU Selection: JP11**

This jumper selects between Intel and Cyrix CPUs. It should be set for the manufacturer of the CPU installed on the board. If the CPU is from a third manufacturer, this setting doesn't matter.

*JP11*

<b>Cyrix</b>	1&2
<b>Intel</b>	2&3



**Cyrix**



**Intel**

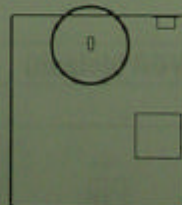

## Level 2 Cache Size: JP13, JP14 & JP27

Set these based on the size of the installed cache and chip configuration used.

Cache Size (Chip Config)	JP13	JP14	JP27
<b>128KB (32K8x4)</b>	Open	2&3	1&2
<b>256KB (32K8x8)</b>	Open	1&2	1&2
<b>256KB (64K8x4)</b>	1&2	2&3	1&2
<b>512KB (64K8x8)</b>	4&5	1&2	2&3
<b>512KB (128K8x4)</b>	1&2	2&3	2&3
<b>1MB (128K8x8)</b>	2&3	1&2	2&3

## Level 2 Cache Configuration Options

### 128KB Cache

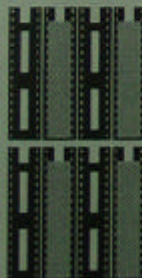

Cache: Four 32K8, 20ns



Tag: One 8K8, 20ns

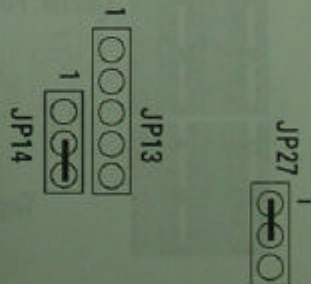

## 256KB Cache

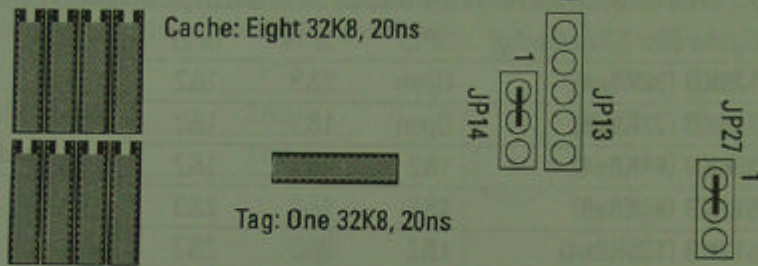

## 256KB Cache

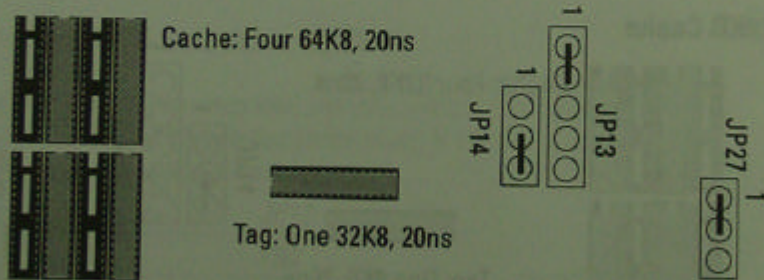

512KB Cache



Cache: Eight 64K8, 20ns



Tag: One 32K8, 20ns

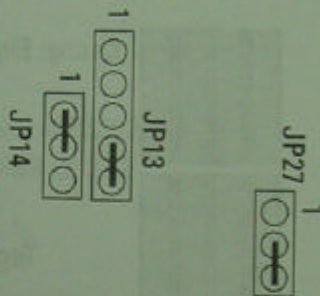

512KB Cache

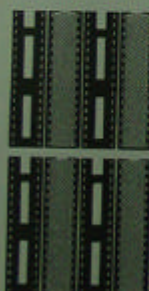

Cache: Four 128K8, 20ns



Tag: One 32K8, 20ns

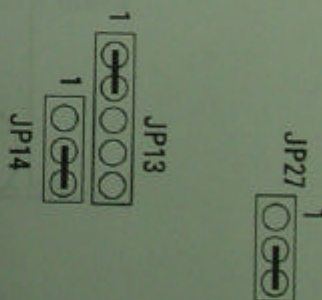



1MB Cache

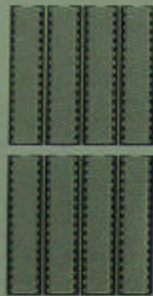

Cache: Eight 128K8, 20ns



Tag: One 64K8, 20ns  
or  
One 128K8, 20ns

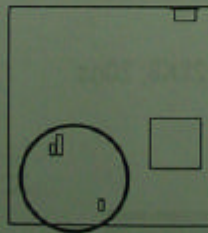
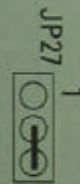
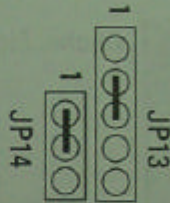

*Try to set JP16 to 5  
JP16 = 4&5 for L1 WB  
JP21 = 2&3 for L1 WT*

**CPU Type Selection: JP16-22**

These jumpers set the CPU type.

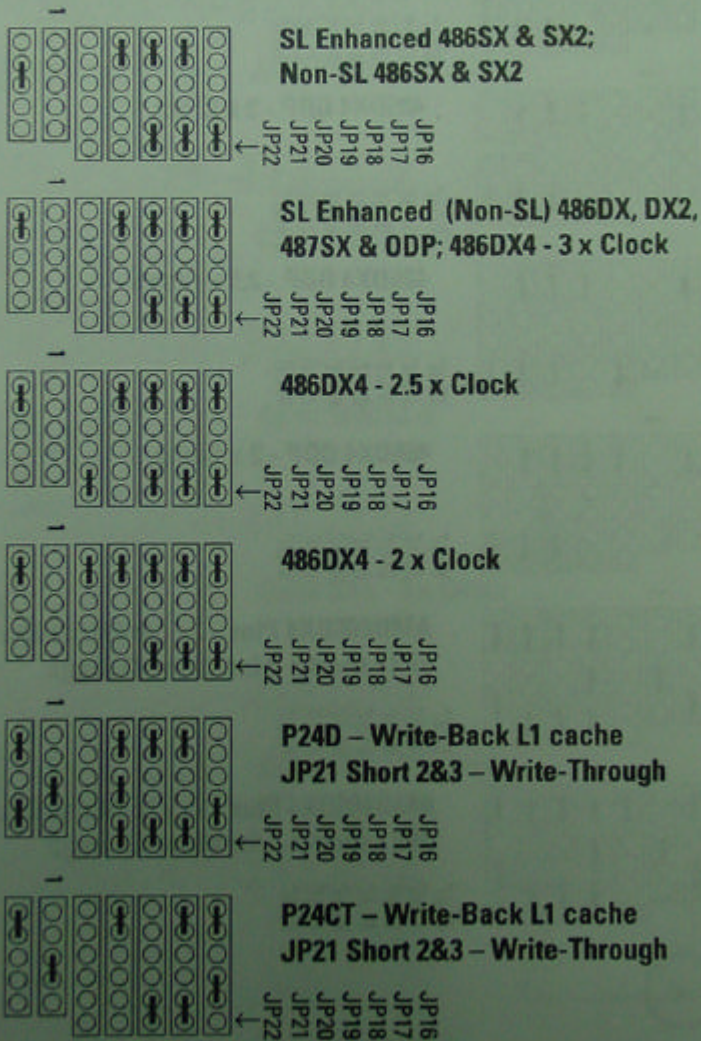

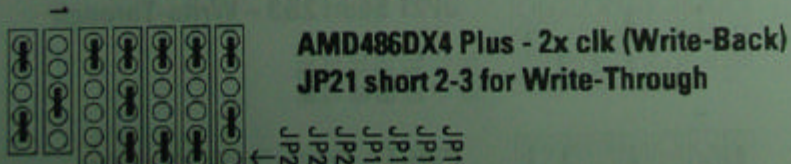
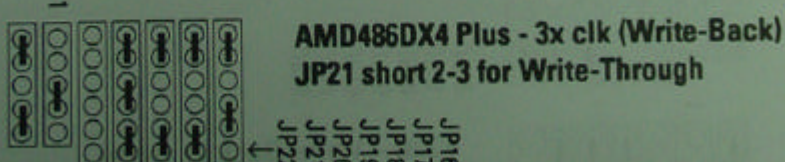
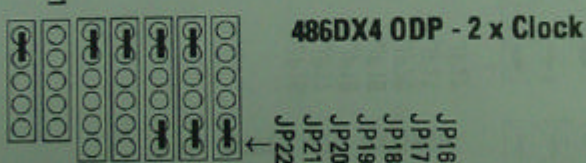
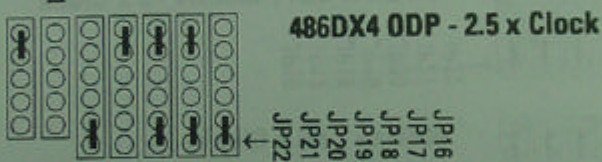
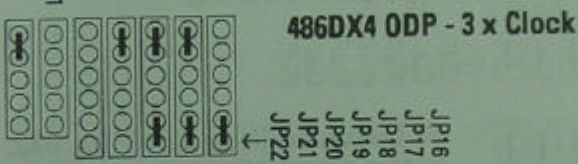
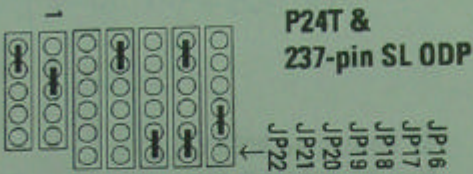

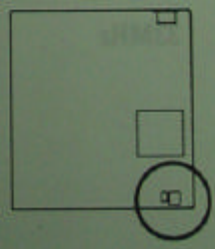
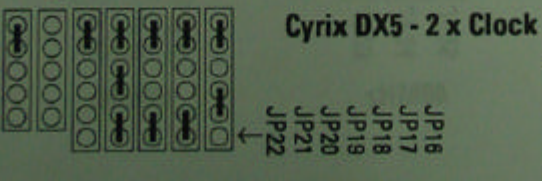
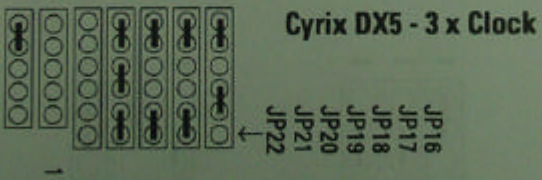
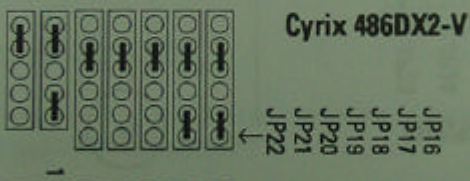
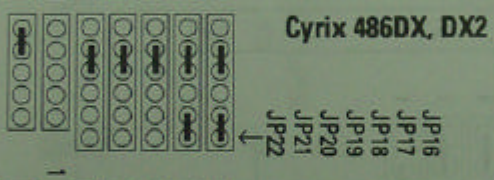
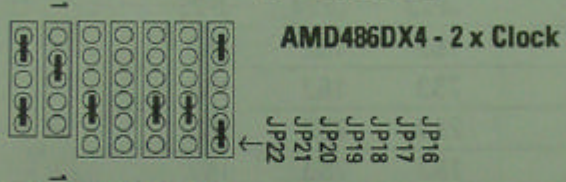
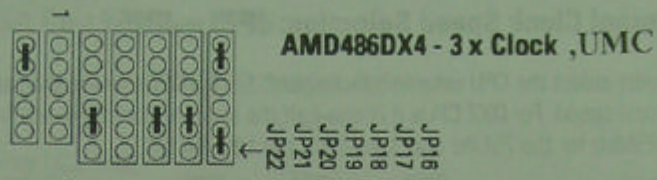

**CPU External Clock Speed Selection: JP23 – JP25**

These jumpers select the CPU external clock speed. For DX CPUs this is the same as the internal speed. For DX2 CPUs it is one-half the internal speed. For a DX4, it should be 25MHz for the 75Mhz and 33MHz for the 100Mhz CPU.

<i>Clock Speed</i>	<i>JP23</i>	<i>JP24</i>	<i>JP25</i>
<b>20MHz</b>	1&2	1&2	1&2
<b>25MHz</b>	2&3	1&2	1&2
<b>33MHz</b>	2&3	2&3	2&3
<b>40MHz</b>	2&3	2&3	1&2
<b>50MHz</b>	1&2	1&2	2&3

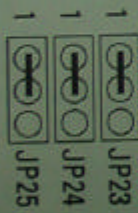
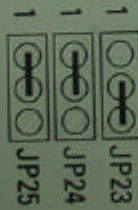
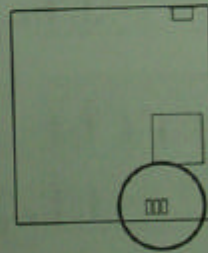
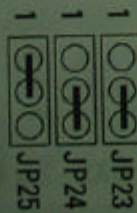
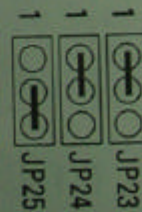
**20MHz****25MHz****33MHz****40MHz****50MHz**

## VESA Clock Delay: JP26

The default setting sets the VESA clock to Delay.

	JP26
<b>Delay (default)</b>	1&2
<b>No Delay</b>	2&3

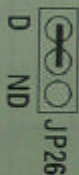

**Delay**

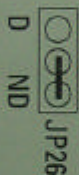

**No Delay**

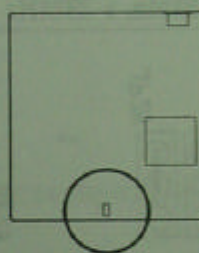

## Cache Size: JP27

This jumper, along with JP13 and 14 set the cache size. Refer to the listing for JP13 and 14 for the settings.

**VL-Bus Clock & Wait State Selection: JP28 – JP29**

These jumpers set the VL-Bus clock and wait state.

Wait State/VL-Bus Clock	JP28	JP29
<b>0 Wait State, ≤ 33MHz</b>	1&2	1&2
<b>1 Wait State, &gt; 33MHz</b>	2&3	2&3

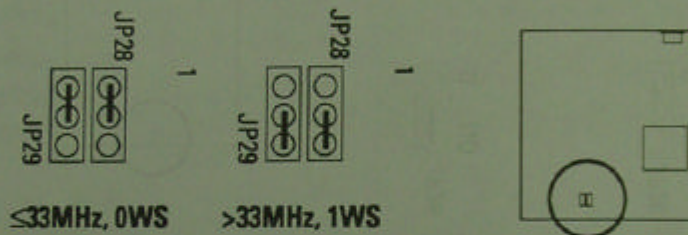
**CPU Voltage Selection: JP32 & JP33**

These jumpers select the CPU voltage. You must make sure that these jumpers are set correctly for the installed CPU.

Voltage	JP32	JP33
<b>3.45-Volt</b>	1&2	Open
<b>3.6-Volt</b>	2&3	Open
<b>4-Volt</b>	Open	1&2
<b>3.3-Volt</b>	Open	2&3

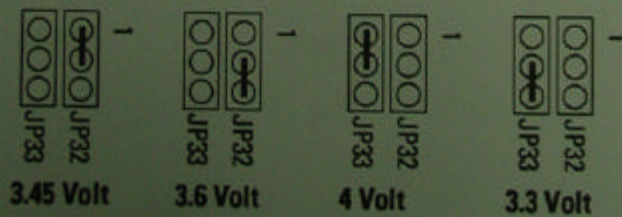
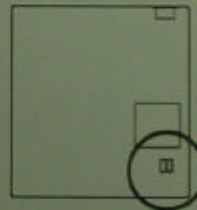

**Memory Subsystem**

**DRAM Specifications:**

See pages 2-5

**Memory Configurations**

See pages 2-6 and 2-7 for chart.

**Level 2 Cache Options**

See jumper section for settings, chip speeds & size configurations..

**Connectors**

There are several connectors on the board for switches and indicator lights from the system case. The connectors are made of the same components as the jumper switches. There is also a double connector for the leads from a system power supply and the connector for the on-board IDE controller:

SMI Switch	Connector for the lead from a Case-mounted Suspend switch.
Turbo Switch	Shorted for maximum speed operation (default), or connector for the lead from a case-mounted Turbo Switch.
Turbo LED	Connector for the lead from a case-mounted Turbo Switch status indicator LED.
Reset Switch	Connector for the lead from a Reset switch mounted on the system case.
Speaker	Connector for the lead from a speaker mounted inside the system case.
KeyLock	Connector for both a case-mounted keyboard lock and a Power-On LED. Pin 1 is live, pins 3 & 5 are grounds.
PS/2 Mouse	Connector for a lead from a case-mounted PS/2 mouse port.
Ext.Batt	Connector for the lead from an external battery.
SMI Out	Connector for the extra lead from a green power supply.



System Case Connectors & IDE/HD LED Connectors

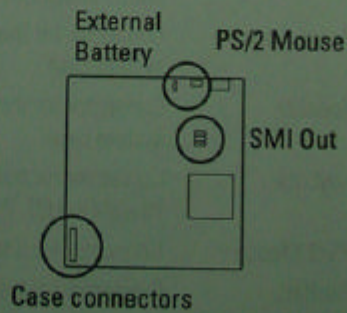
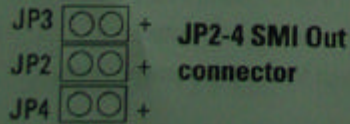
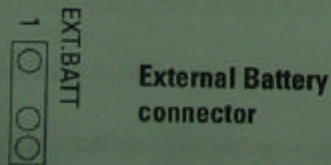
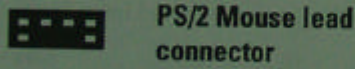
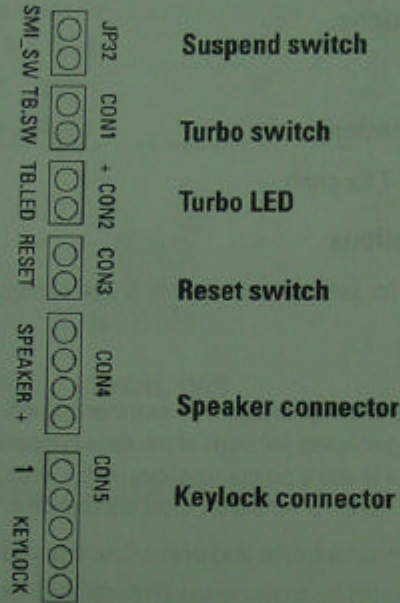

**Connecting A Power Supply**

To connect the leads from the power supply, first make sure the it is unplugged. Most power supplies have two leads. Each lead has six wires, two of which are black. Orient the connectors so the black wires are in the middle.

**Power supply connectors**

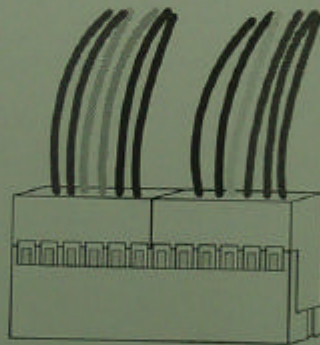

The black wires should be in the middle.

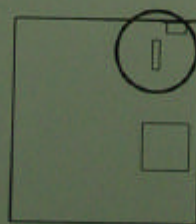

Power  
connector