

SONY[®]

User guide

SmartBand
SWR10

Contents

Basics.....	3
Introduction.....	3
Hardware overview.....	3
Charging your SmartBand.....	3
Assembly.....	4
Turning your SmartBand on and off.....	4
Setting up your SmartBand.....	6
Preparing to use your SmartBand.....	6
Reconnecting your SmartBand.....	7
Day mode and night mode.....	7
Resetting your SmartBand.....	8
Settings for your SmartBand.....	9
Using the SmartBand application.....	9
Auto night mode.....	9
Notifications.....	10
SmartBand alarm.....	10
Out-of-range alert notifications.....	11
Incoming call notifications.....	11
Controlling applications from your SmartBand.....	12
Logging your activities using the Lifelog application.....	13
Using the Lifelog application.....	13
Setting goals.....	15
Logging your sleep with your SmartBand.....	15
Creating life bookmarks.....	15
Important information.....	17
Using your SmartBand in wet and dusty conditions.....	17
Legal information.....	18

Basics

Introduction

Your SmartBand is designed to be worn on your dominant wrist and connects to your Android™ device to help you keep track of your daily activities. Via the Lifelog application on your Android™ device, you can synchronise data with your SmartBand to see how many steps you've taken, check how you've slept, and much more. The SmartBand also has a vibrate function which notifies you of alarms as well as incoming messages and calls. You can even use the SmartBand to control media playback on your Android™ device.

Even when it's not connected to your Android™ device, your SmartBand collects information about your step count as well as data about your walking, running and sleeping, and life bookmarks. Your SmartBand can store this data for up to two weeks.

- ! To use the SmartBand with your Android™ device, make sure that the software version of your Android™ device is Android™ 4.4 or later and that your Android™ device supports the Bluetooth® 4.0 low energy standard. Also, remember that you need an active Internet connection to synchronise data between your SmartBand and Android™ device.

Hardware overview

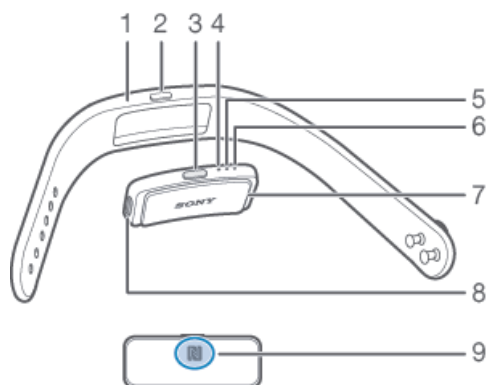

1	Wristband
2	Power key cover
3	Power key
4	Notification light A
5	Notification light B
6	Notification light C
7	Core
8	Micro USB port
9	NFC detection area

Charging your SmartBand

Before using your SmartBand for the first time, you need to charge it for approximately 30 minutes. Sony chargers are recommended.

To charge your SmartBand

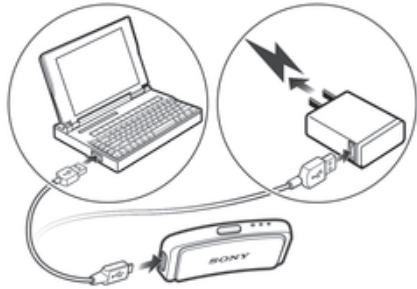

- 1 Plug one end of the USB cable into the charger or into the USB port of a computer.
- 2 Plug the other end of the cable into the Micro USB port of your SmartBand.

Battery notification light status

Notification light A flashes continuously	The battery is charging and is not yet fully charged
Notification light A is on	The battery is fully charged

To check the battery level of your SmartBand

- 1 From the **Home screen** of your Android™ device, tap , then find and tap **Smart Connect**.
- 2 Tap **Devices > SmartBand**.

Low battery level notification

When your SmartBand is on and the battery level is less than 5%, your SmartBand emits two short vibrations and a popup window in the SmartBand application notifies you that your SmartBand is running out of battery.

Assembly

To assemble your SmartBand

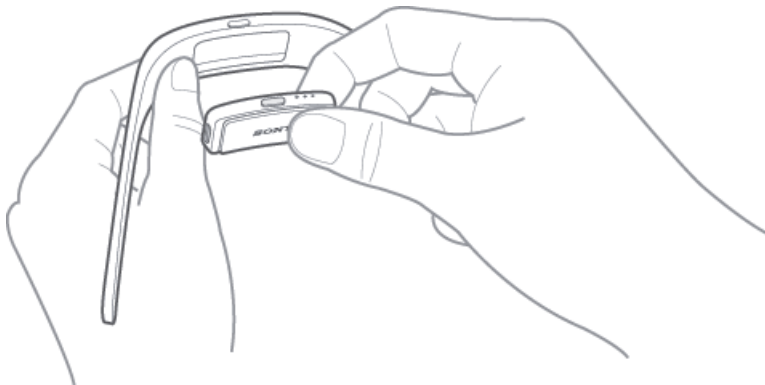

- 1 Select the wristband that best suits you.
- 2 Insert the core into the wristband in such a way that the power key is inserted underneath the power key cover.

Turning your SmartBand on and off

To turn on your SmartBand

- Press and hold down the power key until your SmartBand vibrates.
- ! When turning on your SmartBand for the first time, it automatically enters pairing mode and notification light A flashes until your SmartBand is connected to a device.

To turn off your SmartBand

- Press and hold down the power key until all notification lights are on simultaneously and then turn off one by one.

Setting up your SmartBand

Preparing to use your SmartBand

For your SmartBand to work, it must be connected to your Android™ device and the latest versions of the following applications must be installed on the Android™ device: Smart Connect, SmartBand and Lifelog.

If you set up your SmartBand using NFC, you are guided during setup to Google Play™, from where you can install the necessary applications to use with your SmartBand.

If you set up your SmartBand using Bluetooth®, you have to go through some extra steps to install the necessary applications from Google Play™ and connect to your Android™ device.



- ! The Smart Connect application is pre-installed on all Android™ devices from Sony Mobile at purchase. Make sure that you update it to the latest version.
- 💡 After the SmartBand application is installed, it is not located on the Application screen. You can access it under Devices in the Smart Connect application after your SmartBand is connected to the Android™ device.

To set up your SmartBand using NFC



- 1 Make sure that your SmartBand is charged for at least 30 minutes.
 - 2 Android™ device: Make sure you have installed or updated the Smart Connect application to the latest version from Google Play™.
 - 3 Android™ device: Make sure that the NFC function is turned on and that the screen is active and unlocked.
 - 4 Place the Android™ device over your SmartBand so that the NFC area of each device touches the other, then follow the instructions on the Android™ device to install the SmartBand application and the Lifelog application.  appears briefly in the status bar and permanently in the Notification panel when a connection with the SmartBand is active.
- ! If you touch the NFC areas of each device to each other after all applications are installed and your SmartBand is on and connected, the Lifelog application starts automatically.
 - 💡 You can drag down the status bar to open the Notification panel and get quick access to the SmartBand application and the Lifelog application.

To set up your SmartBand using Bluetooth®

- 1 Make sure that your SmartBand has been charged for at least 30 minutes.
 - 2 Android™ device: Make sure you have installed or updated the Smart Connect application to the latest version from Google Play™.
 - 3 Start the Smart Connect application.
 - 4 Turn on your SmartBand.
 - 5 Android™ device: Turn on the Bluetooth® function, then scan for Bluetooth® devices and select **SWR10** in the list of available devices.
 - 6 Follow the instructions to install the SmartBand application and the Lifelog application.  appears briefly in the status bar and permanently in the Notification panel when a connection with the SmartBand is active.
- ! All applications required for the SmartBand to work are available on Google Play™.
-  You can drag down the status bar to open the Notification panel and get quick access to the SmartBand application and the Lifelog application.



Reconnecting your SmartBand

In cases where a connection gets lost, for example, when the connected Android™ device goes out of range, your SmartBand automatically performs a series of reconnection attempts. If no connection is found after a certain period, your SmartBand stops trying to reconnect. When this happens, you can use the power key to restart the reconnection attempts, or you can use NFC to reconnect the two devices.

To force restart reconnection attempts

- Briefly press the power key.

To reconnect your SmartBand using NFC

- 1 Android™ device: Make sure that the NFC function is turned on and that the screen is active and unlocked.
 - 2 Place the Android™ device over your SmartBand so that the NFC detection area of each device touches the other.  appears briefly in the status bar and permanently in the Notification panel when a connection with the SmartBand is active.
-  You can drag down the status bar to open the Notification panel and get quick access to the SmartBand application and the Lifelog application.

Day mode and night mode

Your SmartBand has two primary modes: day mode and night mode. Each mode is indicated by different notification light patterns. In day mode, your SmartBand vibrates to notify you of alarms and incoming messages and calls. And it logs data about your activities, such as steps you've taken and hours you've walked or run. In night mode, the SmartBand logs your sleep and can wake you up if you've set an alarm. All other functions are turned off.

Mode	Notification light pattern
Day mode	Notification lights illuminate one by one, then all lights go out.
Night mode	The notification lights alternate between one lit and two lit lights.

To check the mode of your SmartBand

- Briefly press the power key. The notification lights blink according to the light pattern for day or night mode.

To switch between day mode and night mode

- Press and hold down the power key for two seconds.

Resetting your SmartBand

Reset your SmartBand if it behaves unexpectedly or if you want to connect it to a new device.

To reset your SmartBand

- 1 Turn off your SmartBand.
- 2 Press and hold down the power key until notification light A starts flashing.

Settings for your SmartBand

Using the SmartBand application

You can view and change settings for your SmartBand from the SmartBand application, which can be accessed under **Devices** in the Smart Connect application.

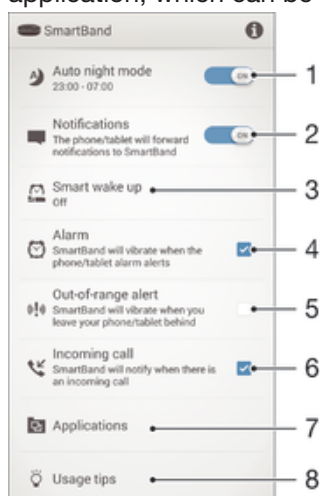

- 1 Turn the auto night mode function on or off.
Set the time period during which auto night mode operates.
- 2 Turn the notifications function on or off.
Select which notifications to forward to your SmartBand.
- 3 Turn the smart wake up function on or off.
Add, edit or delete smart wake up alarms.
- 4 Enable alarm notifications from Xperia™ devices.
- 5 Turn the out-of-range function on or off.
- 6 Turn incoming call notifications on or off.
- 7 Select an application to be controlled by your SmartBand.
Search, download and install new applications from Google Play™.
- 8 Read tips about your SmartBand.

Auto night mode

You can set your SmartBand to switch automatically from day mode to night mode at a selected time and for a selected period. Auto night mode only becomes active if no movement is detected by your SmartBand at the pre-set activation time. If you are still moving around, then it waits until you stop moving. Likewise, in the morning, day mode may become active up to an hour before the pre-set end time for night mode if movement is detected. If the pre-set end time is reached without any movement being detected, the SmartBand stays in night mode and only goes into day mode when movement is detected.

To turn on the auto night mode function

- 1 From the **Home screen** of your Android™ device, tap , then find and tap **Smart Connect**.
- 2 Tap **Devices** > **SmartBand** > **SmartBand**.
- 3 Drag the slider besides **Auto night mode** to the right.

To set a time interval for automatic night mode

- 1 From the **Home screen** of your Android™ device, tap  then find and tap **Smart Connect**.
- 2 Tap **Devices > SmartBand > SmartBand**.
- 3 Tap **Auto night mode**.
- 4 Adjust the settings for time interval, then tap **Set**.
- 5 Tap **Done**.

Notifications

All notifications that appear in the status bar on a connected Android™ device can be forwarded to your SmartBand. When there is an incoming notification, your SmartBand vibrates once and notification light A flashes every six seconds. Use the SmartBand application to select which notifications to forward to your SmartBand.

To turn on the notifications function

- 1 From the **Home screen** of your Android™ device, tap  then find and tap **Smart Connect**.
- 2 Tap **Devices > SmartBand > SmartBand**.
- 3 Drag the slider besides **Notifications** to the right.
- 4 If you are turning on the notifications function for the first time, follow the instructions that appear on the screen to give the SmartBand application access to your notifications.

To select which notifications to forward to your SmartBand

- 1 From the **Home screen** of your Android™ device, tap  then find and tap **Smart Connect**.
- 2 Tap **Devices > SmartBand > SmartBand**.
- 3 Tap **Notifications**.
- 4 In the list that appears, mark or unmark the desired options.

SmartBand alarm

Your SmartBand has two different alarm functions. One is the regular alarm function, which only works when your SmartBand is connected to an Xperia™ device. The other is the smart wake up function, which wakes you up when you have reached a state of light sleep, so you feel refreshed.

Alarm notifications from an Xperia™ device

Your SmartBand vibrates when pre-set alarms go off on a connected Xperia™ device.

To enable alarm notifications from an Xperia™ device

- 1 From the **Home screen** of your Xperia™ device, tap  then find and tap **Smart Connect**.
- 2 Tap **Devices > SmartBand > SmartBand**.
- 3 Mark the **Alarm** checkbox.

To snooze an alarm when it vibrates

- Press the power key.

Smart wake up

You can set one or several smart wake up alarms in the SmartBand application. Smart wake up alarms wake you up at the best time based on your sleep cycle. They notify you with a vibrating alert. The Smart wake up function uses sleep data from your SmartBand over a pre-set time period to wake you up when you reach a state of light sleep.

For example, if you set a smart wake up alarm for 06:30 – 07:00 and your SmartBand is in night mode, it wakes you up sometime between 06:30 and 07:00 when you

reach a state of light sleep. If you do not reach a state of light sleep during this period, the smart wake up alarm wakes you up at 07:00. If your SmartBand is in day mode, the alarm alerts you at 07:00.



To add a smart wake up alarm

- 1 From the **Home screen** of your Android™ device, tap , then find and tap **Smart Connect**.
- 2 Tap **Devices > SmartBand > SmartBand**.
- 3 Tap **Smart wake up**, then tap **+**.
- 4 Tap **Time**, then scroll up or down to adjust the setting and tap **Set**.
- 5 Tap **Repeat**, then mark the days for the alarm recurrence and tap **OK**.
- 6 Tap **Wake up interval**, then select an option.
- 7 Tap **Done**.

To edit an existing smart wake up alarm

- 1 From the **Home screen** of your Android™ device, tap , then find and tap **Smart Connect**.
- 2 Tap **Devices > SmartBand > SmartBand**.
- 3 Tap **Smart wake up**, then tap the alarm that you want to set.
- 4 Tap **Time**, then scroll up or down to adjust the setting and tap **Set**.
- 5 Tap **Repeat**, then mark the days for the alarm recurrence and tap **OK**.
- 6 Tap **Wake up interval**, then select an option.
- 7 Tap **Done**.

To delete a smart wake up alarm

- 1 From the **Home screen** of your Android™ device, tap , then find and tap **Smart Connect**.
- 2 Tap **Devices > SmartBand > SmartBand**.
- 3 Tap **Smart wake up**, then touch and hold the alarm that you want to delete.
- 4 Tap , then tap **Yes**.

To turn on a smart wake up alarm

- 1 From the **Home screen** of your Android™ device, tap , then find and tap **Smart Connect**.
- 2 Tap **Devices > SmartBand > SmartBand**.
- 3 Tap **Smart wake up**, then drag the slider beside the smart wake up alarm that you want to activate to the right.

To turn off a smart wake up alarm when it vibrates

- Press the power key.

Out-of-range alert notifications

You can receive a notification when you leave your Android™ device behind by turning on the out-of-range alert notification function. Your SmartBand then notifies you with three short vibrations when the distance between your SmartBand and the connected Android™ device becomes too great and causes a disconnection.

To turn on the out-of-range alert notification function

- 1 From the **Home screen** of your Android™ device, tap , then find and tap **Smart Connect**.
- 2 Tap **Devices > SmartBand > SmartBand**.
- 3 Mark the **Out-of-range alert** checkbox.

Incoming call notifications

Your SmartBand notifies you with continuous vibrations when a call is coming in.

To turn on the incoming call notification function

- 1 From the **Home screen** of your Android™ device, tap  then find and tap **Smart Connect**.
- 2 Tap **Devices > SmartBand > SmartBand**.
- 3 Mark the **Incoming call** checkbox.

To mute the ringtone for an incoming call

- Briefly press the power key on your SmartBand.

Controlling applications from your SmartBand

You can control a selected application on the connected Android™ device using your SmartBand. For example, if you have selected the Media player, you can control media playing on the connected Android™ device using your SmartBand.

To select an application to control using your SmartBand

- 1 From the **Home screen** of your Android™ device, tap  then find and tap **Smart Connect**.
- 2 Tap **Devices > SmartBand > SmartBand**.
- 3 Tap **Applications**, then tap the item under **SELECT APPLICATION**.
- 4 Select an option, then tap **Done**.

To control media playback on your Android™ device from your SmartBand

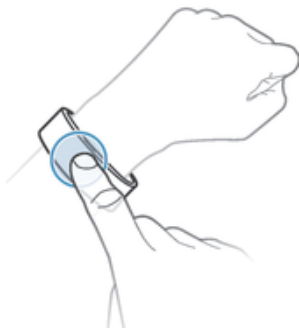

- 1 Make sure that your SmartBand is connected to your Android™ device.
- 2 Select Media player as the application that can be controlled through your SmartBand.
- 3 Press the power key.
- 4 To play or pause the media file, tap the SmartBand once. To go to the next media file, tap twice. To go to the previous media file, tap three times.
- 5 To deselect the Media player as the application controlled by your SmartBand, press the power key or wait for 15 seconds without touching the SmartBand (to allow the application to be deselected automatically).

Logging your activities using the Lifelog application

Using the Lifelog application

The Lifelog application records your physical, social and entertainment activities. For example, you can see if you've been walking or running and how you communicate with your friends. You can also see what pictures you took and what music you listened to. To start using the Lifelog application, you need to download it from Google Play™ and then set up an account.

- 💡 The statistics that the Lifelog application generates from your physical activities, for example, walking distance and calorie count, are based on the height and weight data you provide. Results may vary from user to user.

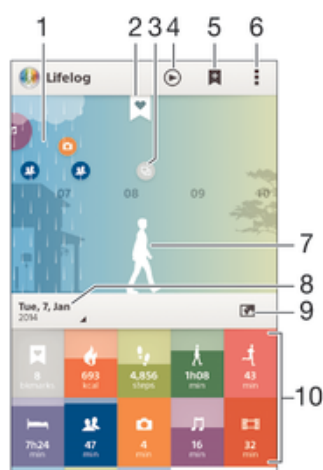

- 1 Show all logged activities and life bookmarks
- 2 View detailed information about a life bookmark
- 3 View information about application usage
- 4 View all logged activities since the start of the day
- 5 Add a life bookmark
- 6 View menu options
- 7 Physical activities log
- 8 View all logged activities for the selected day
- 9 Switch between dashboard and map view
- 10 Activities dashboard

To set up an account for the Lifelog application

- 1 From the **Home screen** of your Android™ device, tap , then find and tap **Lifelog**.
- 2 Follow the instructions that appear on the screen and accept the terms and conditions.
- 3 Create a new account or select to use an existing one. Sony PlayStation® Network accounts can also be used.
- 4 Follow the instructions that appear on the screen to create a Lifelog account.



To log in to the Lifelog application

- 1 From the **Home screen** of your Android™ device, tap , then find and tap **Lifelog**.
- 2 Follow the instructions that appear on the screen and accept the terms and conditions.



Adjusting the stride length for walking and running

The Lifelog application uses the number of steps you have taken and your stride length to calculate the distance you have walked or run. The automatic stride length used by default is based on your gender and height. If you feel that the distances measured by the Lifelog application are not accurate enough, you can adjust your stride length.

To adjust the stride length for walking

- 1 From the **Home screen** of your Android™ device, tap  then find and tap **Lifelog**.
- 2 Tap  > **Settings** > **Profile**.
- 3 Find and tap **Stride length**.
- 4 Unmark the **Automatic** checkbox if it is marked, then scroll up or down to adjust the setting and tap **Set**.

To adjust the stride length for running

- 1 From the **Home screen** of your Android™ device, tap  then find and tap **Lifelog**.
- 2 Tap  > **Settings** > **Profile**.
- 3 Find and tap **Running stride length**.
- 4 Unmark the **Automatic** checkbox if it is marked, then scroll up or down to adjust the setting and tap **Set**.

Activity box overview

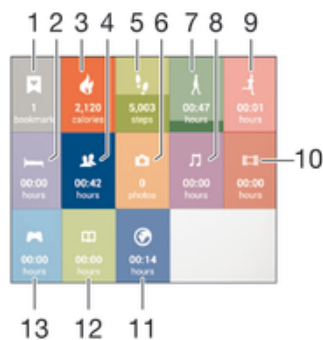

- 1 View all logged life bookmarks
- 2 View your sleep hours and check the quality of your sleep based on the information collected
- 3 View the amount of active calories that you have burned while exercising and the passive calories that you have burned while not exercising
- 4 View the time you have spent using communication applications from Google Play™ and some other applications such as the Phone and the Messaging applications from Sony
- 5 View the number of steps you have taken and logged in the Lifelog application
- 6 View how many photos you have taken
- 7 View the total time you have spent walking for longer than just a few steps
- 8 View the time you have spent listening to music using applications from Google Play™ and some other applications such as the "WALKMAN" application
- 9 View the total time you have spent running with a high steps-per-minute ratio for longer than just a few steps
- 10 View your total time spent watching movies, TV shows and other video content using applications from Google Play™ and some other applications
- 11 View your total time spent browsing while using applications from Google Play™ and some other web browsers
- 12 View your total time spent reading books or comics using applications from Google Play™ and some other applications

Activity overview



- 1 Show data in a day, week, month or year view
- 2 Show your current goal status
- 3 Show the current activity in different units
- 4 Show the amount of activity using the chosen unit type
- 5 Details about your activity

Setting goals

Set goals for activities in your daily life, for example, the number of steps to take, the distance you want to walk, or the amount of calories you want to burn.

To set a goal

- 1 In the Lifelog application, tap the activity that you want to set a goal for.
- 2 Tap **Day**, then tap the goal dashboard.
- 3 Scroll up or down to adjust the value for your goal, then tap **Set**.

Logging your sleep with your SmartBand

Your SmartBand can log the hours you sleep, as well as the status for light sleep, deep sleep and your awake time during sleep hours to help you understand your sleep quality. The data that your SmartBand tracks is logged in the Lifelog application. In order to log sleep data, SmartBand must be in night mode.

To view your sleep data

- In the Lifelog application, tap **Sleep** from the Activities dashboard.

Creating life bookmarks

Use your SmartBand to create life bookmarks. Life bookmarks save information about time and locations, and help you remember special occasions. For location data to be gathered, you must have an active Internet connection.

To create a life bookmark using the Lifelog application

- 1 In the Lifelog application, tap .
- 2 Follow the on-screen instructions.
- 3 If necessary, add text notes, then tap **OK**.

To create a life bookmark using your SmartBand

- 1 Make sure that your SmartBand is turned on and in day mode.
- 2 Press the power key twice to log the place and time.
- 3 Connect your SmartBand to your Android™ device. If necessary, add notes to the bookmark using the Lifelog application.

Important information

Using your SmartBand in wet and dusty conditions

Your SmartBand is waterproof and dust resistant in compliance with the Ingress Protection (IP) ratings IP55 and IP58, as explained in the table below.

These specific IP ratings mean that your SmartBand is dust resistant and is protected against low pressure water stream as well as against the effects of immersion for 30 minutes in fresh (non-saline) water up to 3 metres deep.

You can use your SmartBand:

- in dusty environments, for example, on a windy beach.
- when your fingers are wet.
- in some extreme weather conditions, for example, when it's snowing or raining.
- in fresh (non-saline) water depths of 3 metres or less, for example, in a fresh water lake or river.
- in a chlorinated swimming pool.

Even if your SmartBand is resistant to dust and water, you should avoid exposing it unnecessarily to environments with excessive dust, sand and mud or to moist environments with extreme high or low temperatures. The waterproof ability of the micro USB port cannot be guaranteed in all environments or conditions.

Never immerse your SmartBand in salt water or let the micro USB port come in contact with salt water. For example, if you're at the beach, remember to keep your SmartBand away from the sea water. Also, never expose the SmartBand to any liquid chemicals. For example, if you're washing dishes by hand using liquid detergent, avoid bringing your SmartBand in contact with the detergent. After exposure to non-fresh water, rinse your SmartBand using fresh water.

Normal wear and tear along with damage to your SmartBand can reduce its ability to resist dust or moisture. After using the SmartBand in water, dry off the areas around the micro USB port.

All compatible accessories, including batteries, chargers and micro USB cables, are not waterproof and dust resistant on their own.

Your warranty does not cover damage or defects caused by abuse or improper use of your SmartBand (including use in environments where the relevant IP rating limitations are exceeded). If you have any further questions about the use of your products, refer to our Customer support service for help. To view more specific information about water resistance, go to <http://www.sonymobile.com/global-en/support/discover-more/water-and-dust-resistance/>.

Ingress Protection Rating

Your SmartBand has an IP rating, which means it has undergone certified tests to measure its resistance levels to both dust and water. The first digit in the two-digit IP rating indicates the level of protection against solid objects, including dust. The second digit indicates how resistant the device is to water.

Resistance to solid objects and dust	Resistance to water
IP0X: No special protection	IPX0: No special protection
IP1X: Protected against solid objects > 50 mm in diameter	IPX1: Protected against dripping water
IP2X: Protected against solid objects > 12.5 mm in diameter	IPX2: Protected against dripping water when tilted up to 15 degrees from normal position
IP3X: Protected against solid objects > 2.5 mm in diameter	IPX3: Protected against spraying water
IP4X: Protected against solid objects > 1 mm in diameter	IPX4: Protected against splashing water
IP5X: Protected against dust; limited ingress (no harmful deposit)	IPX5: Protected against water jet spray for at least 3 minutes
IP6X: Dust tight	IPX6: Protected against heavy jet spray for at least 3 minutes

IPX7. Protected against the effects of immersion in up to 1 metre of water for 30 minutes

IPX8. Protected against the effects of continued immersion in water depths greater than 1 metre. The exact conditions are specified for each device by the manufacturer.

Legal information

Sony SWR10



Prior to use, please read the *Important information* leaflet separately provided.

This User guide is published by Sony Mobile Communications AB or its local affiliated company, without any warranty. Improvements and changes to this User guide necessitated by typographical errors, inaccuracies of current information, or improvements to programs and/or equipment, may be made by Sony Mobile Communications AB at any time and without notice. Such changes will, however, be incorporated into new editions of this User guide.

All rights reserved.

©2014 Sony Mobile Communications AB.

Interoperability and compatibility among Bluetooth® devices varies. Device generally supports products utilizing Bluetooth spec. 1.2 or higher, and Headset or Handsfree profile.

Sony is the trademark or registered trademark of Sony Corporation. Bluetooth is the trademark of the Bluetooth (SIG) Inc. and is used under license. All other marks are the property of their respective owners. All rights reserved.

All product and company names mentioned herein are the trademarks or registered trademarks of their respective owners. Any rights not expressly granted herein are reserved. All other trademarks are property of their respective owners.

Visit www.sonymobile.com for more information.

All illustrations are for illustration only and may not accurately depict the actual accessory.

Declaration of Conformity

We, Sony Mobile Communications AB of
Nya Vattentornet
SE-221 88 Lund, Sweden
declare under our sole responsibility that our product
Sony type **RD-0070**
and in combination with our accessories, to which this declaration relates is in
conformity with the appropriate standards **EN 300 328:V1.8.1, EN 301
489-17:V2.2.1, EN 301 489-3:V1.4.1, and EN 60 950-1:2006 +A11:2009 +A1:2010**
following the provisions of, Radio Equipment and Telecommunication Terminal
Equipment directive 1999/5/EC.

Lund, November 2013

CE 0682



Pär Thuresson,
Quality Officer, SVP, Quality & Customer Services

FCC Statement

This device complies with Part 15 of the FCC rules. Operation is subject to the following two conditions: (1) This device may not cause harmful interference, and (2) This device must accept any interference received, including interference that may cause undesired operation. Any change or modification not expressly approved by Sony may void the user's authority to operate the equipment.



This equipment has been tested and found to comply with the limits for a Class B digital device, pursuant to Part 15 of the FCC Rules. These limits are designed to provide reasonable protection against harmful interference in a residential installation. This equipment generates, uses and can radiate radio frequency energy and, if not installed and used in accordance with the instructions, may cause harmful interference to radio communications. However, there is no guarantee that interference will not occur in a particular installation.

If this equipment does cause harmful interference to radio or television reception, which can be determined by turning the equipment off and on, the user is encouraged to try to correct the interference by one or more of the following measures:

- Reorient or relocate the receiving antenna.
- Increase the separation between the equipment and receiver.
- Connect the equipment into an outlet on a circuit different from that to which the receiver is connected.
- Consult the dealer or an experienced radio/TV technician for help.

AVISO IMPORTANTE PARA MÉXICO

La operación de este equipo está sujeta a las siguientes dos condiciones: (1) es posible que este equipo o dispositivo no cause interferencia perjudicial y (2) este equipo o dispositivo debe aceptar cualquier interferencia, incluyendo la que pueda causar su operación no deseada.

Para consultar la información relacionada al número del certificado, refiérase a la etiqueta del empaque y/o del producto.

Industry Canada Statement

This device complies with RSS-210 of Industry Canada.

Operation is subject to the following two conditions: (1) this device may not cause interference, and (2) this device must accept any interference, including interference that may cause undesired operation of the device.

This Class B digital apparatus complies with Canadian ICES-003.

Cet appareil numérique de la classe B est conforme à la norme NMB-003 du Canada.

Avis d'industrie Canada

Le présent appareil est conforme aux CNR d'Industrie Canada applicables aux appareils radio exempts de licence.

L'exploitation est autorisée aux deux conditions suivantes: (1) l'appareil ne doit pas produire de brouillage, et, (2) l'utilisateur de l'appareil doit accepter tout brouillage radioélectrique subi, même si le brouillage est susceptible d'en compromettre le fonctionnement.