

MAP 0600: Diskette Drive Start

Symptom Explanation	Conditions That Could Cause This Symptom
You have entered this MAP because you received a 6XX error code, or you have been directed here from another MAP.	<ul style="list-style-type: none">• The diskette drive is failing.• The signal cable is failing.• The diskette drive adapter is failing.• The power supply is failing.

001

Find your system type in the following figure and refer to the MAP indicated.

System Type	MAP Name
Personal Computer.....	MAP 0600: Full-High Diskette Drive
Personal Computer XT.....	MAP 0600: Full-High Diskette Drive
<i>Portable</i> Personal Computer.....	MAP 0600: Diskette Drive (Portable PC)
Personal Computer AT.....	MAP 0600: Diskette Drive (AT)

Figure 1. System Identification

Notes:



MAP 0600: Full-High Diskette Drive

Symptom Explanation	Conditions That Could Cause This Symptom
You have entered this MAP because you received a 6XX error code, or you have been directed here from another MAP.	<ul style="list-style-type: none">• The diskette drive is failing.• The diskette drive adapter is failing.• The system board is failing.• The diskette drive signal cable is failing.• The power supply is failing.

Refer to Figure 1 and determine the type of diskette drives installed in the system.

- Type 1 diskette drives have an A, B, or no character before the serial number.
- Type 2 diskette drives have a D before the serial number.
- Type 3 diskette drives have an E before the serial number.

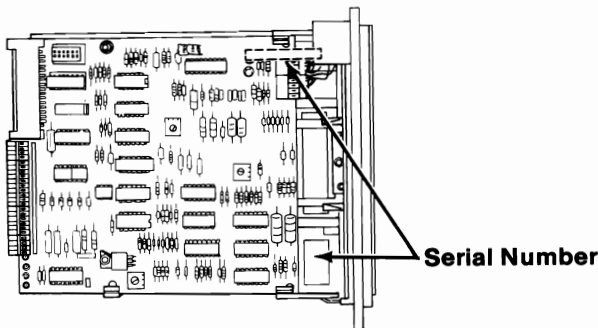

Figure 1. Diskette Drive Type

Test Point Reference pages are at the end of this MAP. These pages identify the test points and pin locations called out in this MAP. Diskette drive-motor speed adjustment procedures are also provided.

(Step 001 continues)

001

- Power off the system.
- Ensure the terminating resistor is installed in drive A and no terminating resistor is installed in drive B.
- Insert the Advanced Diagnostics diskette into drive A.
- Power on the system and observe the light-emitting diode (LED) on drive A during the POST.

DID THE LED ON DRIVE A COME ON BEFORE THE BEEP AT THE END OF THE POST?

Yes No

002

Go to Step 014 in this MAP.

003

IS THE ADVANCED DIAGNOSTICS MENU DISPLAYED?

Yes No

004

Go to Step 024 in this MAP.

005

- Test the write-protect feature as follows:
 1. Select **1 (FORMAT DISKETTE)**.
 2. Remove the Advanced Diagnostics diskette from drive A.
 3. Insert a formatted write-protected scratch diskette into drive A.
 4. Press **A** then **Enter**.



**FORMAT NOT COMPLETED
WRITE PROTECTED DISKETTE
DRIVE A, TRACK 0, HEAD 0, SECTOR 0**

Figure 2. Write Protect Error

(Step 005 continues)

005 (continued)

DID A WRITE PROTECT ERROR MESSAGE APPEAR ON THE SCREEN? (Figure 2 on page 0600-2)

Yes No

006

Go to Step 084 in this MAP.

007

The write-protect feature is working properly on drive A.

- Remove the scratch diskette from drive A.
- Insert the Advanced Diagnostics diskette into drive A.
- Run the Diskette Drives and Adapter tests one time. Use the **(RUN TESTS MULTIPLE TIMES)** option.
- Note any messages that appear on the screen.

DID YOU RECEIVE AN ERROR MESSAGE?

Yes No

008

Go to Step 074 in this MAP.

009

Refer to Figure 3. The fourth character of the message line indicates which diskette drive is failing. If the character is 0, drive A is failing. If the character is 1, drive B is failing.

Note: If more than one error message appears, refer to line 2 of the first error message.

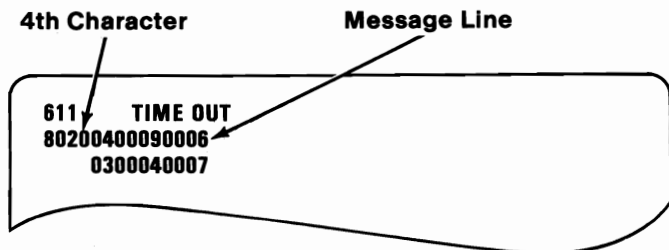

Figure 3. Error Message

009 (continued)

IS THE FOURTH CHARACTER OF THE MESSAGE LINE ZERO?

Yes **No**

|
|
010

- Power off the system. Exchange the signal cable connectors between drives A and B. The diskette drive in the drive B slot is now recognized by the system as diskette drive A. Go back to the beginning of this MAP and start again.

If you still have the same failure after exchanging connectors, go to Step 077 in this MAP.

011

- Repeat the Diskette Drives and Adapter tests using another formatted scratch diskette in the failing drive.

DO YOU STILL HAVE AN ERROR MESSAGE?

Yes **No**

|
|
012

- The diskette you used for the first test is either defective or improperly formatted.

013

- Find the error code in Figure 4 on page 0600-5, and take the action indicated.

Error Code	Probable Cause	Corrective Action
606 621 622 623 625 626	- Signal Cable - Diskette Drive Adapter - Diskette Drive	Go to Step 066 in this MAP
607	Write Protect Error	Go to Step 084 in this MAP
608	There is a problem with your Advanced Diagnostics diskette.	Use your backup copy of the Advanced Diagnostics diskette.
612 613	- Signal Cable - Diskette Drive Adapter	Go to Step 066 in this MAP
611	- Signal Cable - Diskette Drive Adapter - Diskette Drive	Go to Step 091 in this MAP
624	- Signal Cable - Diskette Drive Adapter - Diskette Drive	Go to Step 099 in this MAP

Figure 4. Error Codes

014

(From Step 002 in this MAP)

You may have a bad LED.

- Remove the Advanced Diagnostics diskette.
- Power off the system for about 5 seconds.
- Power on the system.
- Check the voltage between test points C and D while the diskette drive spindle is turning (see the Test Point Reference page).

DID THE VOLTAGE MEASURE CORRECTLY AS DESCRIBED ON THE TEST POINT REFERENCE PAGE?

Yes No

|

015

Go to Step 017 in this MAP.

(Step 016 continues)

016

Replace the LED assembly.

017

(From Step 015 in this MAP)

- Check the power connector at drive A for the voltages listed in Figure 5.

Voltage (Vdc)		Pins	
Minimum	Maximum	-Lead	+Lead
+ 4.8	+ 5.2	2	4
+11.5	+12.6	3	1

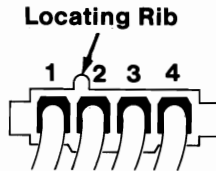

Figure 5. Diskette Drive Power Connector

ARE THE VOLTAGES CORRECT?

Yes No

018

Go to "MAP 0020: Power Start."

019

- Power off the system for about 5 seconds.
- Power on the system.
- Monitor the voltage at pin 12 of the diskette drive logic board from the start of the POST until the end of the POST.

Note: Use the frame as ground.

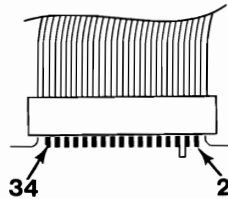

Figure 6. Signal Connector - Pin 12

WAS THE VOLTAGE APPROXIMATELY 5 VDC AT THE START OF THE POST?

Yes No

|

|

020

Replace the diskette drive logic board.

021

DID THE VOLTAGE DECREASE TO APPROXIMATELY 0 VDC BEFORE THE BEEP AT THE END OF THE POST?

Yes No

|

|

022

Go to Step 077 in this MAP.

023

Replace the diskette drive logic board.

024

(From Step 004 in this MAP)

- Remove the Advanced Diagnostics diskette from the drive.
- Power off the system for about 5 seconds.
- Power on the system and observe the spindle on drive A during the POST.

DID THE SPINDLE BEGIN TO ROTATE BEFORE THE BEEP AT THE END OF THE POST?

Yes No

|

|

(Step 025 continues)

025

Go to Step 049 in this MAP.

026

- Perform the preliminary speed check on drive A (see the Test Point Reference page).

Note: Do not adjust the speed until this MAP instructs you to do so.

IS THE SPEED CORRECT?

Yes No

027

Go to Step 029 in this MAP.

028

Go to Step 034 in this MAP.

029

(From Step 027 in this MAP)

ARE YOU CHECKING EITHER A TYPE 1 OR 2 DRIVE?

Yes No

030

Go to Step 059 in this MAP.

031

- Adjust the drive-motor speed (see the Test Point Reference page).

IS THE SPEED NOW CORRECT?

Yes No

032

Go to Step 053 in this MAP.

033

Go to Step 001 in this MAP to verify system operation.

034

(From Step 028 in this MAP)

- Power off the system.
- Remove the diskette drive logic board.
- Move the read/write head assembly to track 0 (rear of the drive).

Note: You should feel some resistance, but the head should not bind.

DID THE HEAD MOVE TO TRACK 0 WITHOUT BINDING?

Yes	No
-----	----

		035
--	--	------------

		Replace the diskette drive.
--	--	-----------------------------

036

- With the head at track 0, install the diskette drive logic board.
- Power on the system.
- Check the voltage between Test Point E and ground for the conditions described on the Test Point Reference page.

Note: The head may move away from track 0 during this test. The head must be manually moved back to track 0 if you want to check the voltage again.

IS THE VOLTAGE CORRECT?

Yes	No
-----	----

		037
--	--	------------

		Replace the diskette drive.
--	--	-----------------------------

038

- Power off the system.
- Remove the diskette drive logic board.
- Move the read/write head assembly to track 0 (rear of the drive).
- Install the diskette drive logic board.
- Power on the system.
- Monitor the voltage at pin 26 of the diskette drive logic board from the start of the POST until the end of the POST.

Note: Use the frame as ground.

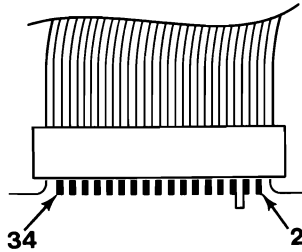

Figure 7. Signal Connector - Pin 26

WAS THE VOLTAGE APPROXIMATELY 5 VDC AT THE START OF THE POST?

Yes No

039

Go to Step 077 in this MAP.

040

DID THE VOLTAGE DECREASE TO APPROXIMATELY 0 VDC BEFORE THE BEEP AT THE END OF THE POST?

Yes No

041

Replace the diskette drive logic board.

042

- Power off the system for about 5 seconds.
- Power on the system.
- Check that the voltage at pin 18 on the diskette drive logic board meets the following conditions:

Note: Use the frame as ground.

- The voltage is approximately 5 Vdc at the start of the POST.
- The voltage decreases to approximately 0 Vdc before the beep at the end of the POST.

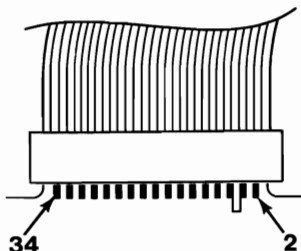

Figure 8. Signal Connector - Pin 18

WERE BOTH CONDITIONS MET?

Yes No

043

Go to Step 077 in this MAP.

044

- Power off the system.
- Remove the mounting screws from the diskette drive logic board.
- Disconnect the read/write head connectors. Leave all other connectors connected.
- Lift the diskette drive logic board enough to see the read/write head assembly.
- Move the read/write head assembly to track 0 (rear of drive).
- Power on the system and observe the motion of the read/write head assembly. It should move from track 0 forward to track 39 and back to track 0.

Note: Type 3 drives perform this exercise twice.

DID THE HEAD ASSEMBLY MOVE FROM TRACK 0 TO TRACK 39 AND BACK TO TRACK 0 (TWICE WITH A TYPE 3 DRIVE)?

Yes No

045

Replace the diskette drive.

046

(Step 046 continues)

046 (continued)

- Power off the system.
- Install the diskette drive logic board.
- Connect the read/write head connectors.
- Insert the Advanced Diagnostics diskette into drive A.
- Power on the system and check for a change in voltage between Test Point F and ground as described on the Test Point Reference page.

DID THE VOLTAGE CHANGE AS DESCRIBED ON THE TEST POINT REFERENCE PAGE?

Yes No

|

047

Replace the diskette drive.

048

Go to Step 077 in this MAP.

049

(From Step 025 in this MAP)

- Check the power connector at drive A for the voltages listed in Figure 9.

Voltage (Vdc)		Pins	
Minimum	Maximum	-Lead	+Lead
+ 4.8	+ 5.2	2	4
+11.5	+12.6	3	1

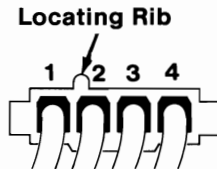

Figure 9. Diskette Drive A Power Connector

ARE THE VOLTAGES CORRECT?

Yes No

|

050

(Step 050 continues)

050 (continued)
Go to "MAP 0020: Power Start."

051

- Power off the system for about 5 seconds.
- Power on the system and check that the voltage at pin 16 of the diskette drive logic board meets the following conditions:

Note: Use the frame as ground.

- The voltage is approximately 5 Vdc at the start of the POST.
- The voltage decreases to approximately 0 Vdc before the beep at the end of the POST.

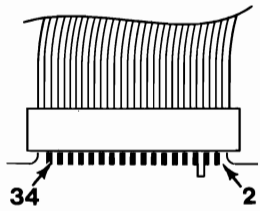

Figure 10. Signal Connector - Pin 16

WERE BOTH CONDITIONS MET?

Yes	No
	052
	Go to Step 077 in this MAP.

053

(From Steps 032, 072, and 111 in this MAP)

IS A SERVO BOARD MOUNTED TO THE BACK OF THE DRIVE?

Yes	No
	054
	(Step 054 continues)

054 (continued)

Go to Step 059 in this MAP.

055

- Check the voltage between P20-1 and P20-2 (ground) on the servo board.

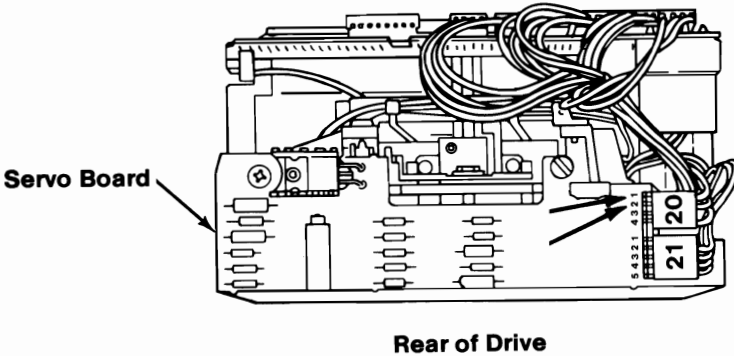

Figure 11. Servo Board - Pin P20-1 and P20-2

IS THE VOLTAGE APPROXIMATELY 12 VDC?

Yes No

056

Replace the diskette drive logic board.

057

- Power off the system for about 5 seconds.
- Power on the system and check that the voltage at pin P20-4 on the servo board meets the following conditions:

Note: Use the frame as ground.

- The voltage is approximately 5 Vdc at the start of the POST.
- The voltage decreases to approximately 0 Vdc when the LED lights.

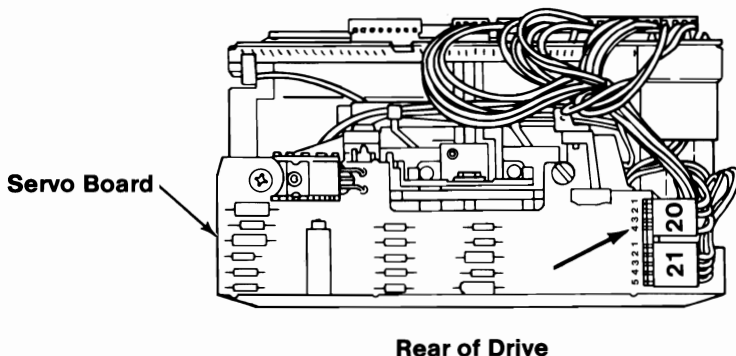

Figure 12. Servo Board - Pin P20-4

WERE BOTH CONDITIONS MET?

Yes No

058

Replace the diskette drive logic board.

059

(From Steps 030, 054, 070, and 109 in this MAP)

IS THE DRIVE BELT CORRECTLY INSTALLED ON THE PULLEYS AND IN GOOD CONDITION?

Yes No

060

Replace the drive belt.

061

- Power off the system.
- Remove the drive belt and turn the spindle drive pulley (large pulley) by hand.

DOES THE SPINDLE DRIVE PULLEY TURN FREELY?

Yes No

062

Replace the spindle assembly.

(Step 063 continues)

063

- Install the drive belt.
- Power on the system and check the voltage between test point G and ground when the LED is lit (see the Test Point Reference page).

IS THE VOLTAGE CORRECT AS DESCRIBED ON THE TEST POINT REFERENCE PAGE?

Yes No

064

Replace the servo board. If that does not correct the problem, replace the diskette drive logic board.

065

Replace the diskette drive motor.

066

(From Step 013 in this MAP)

- Perform the preliminary speed check on drive A (see the Test Point Reference page).

Note: Do not adjust the speed until this MAP instructs you to do so.

IS THE SPEED CORRECT?

Yes No

067

Go to Step 069 in this MAP.

068

Go to Step 077 in this MAP.

069

(From Step 067 in this MAP)

(Step 069 continues)

069 (continued)

ARE YOU CHECKING EITHER A TYPE 1 OR TYPE 2 DRIVE?

Yes No

070

Go to Step 059 in this MAP.

071

- Adjust the drive-motor speed (see the Test Point Reference page).

IS THE SPEED NOW CORRECT?

Yes No

072

Go to Step 053 in this MAP.

073

Go to Step 096 in this MAP.

074

(From Step 008 in this MAP)

- Type 1 diskette drives without a connector on P5 are single-sided drives.
- All type 2 and type 3 diskette drives are double-sided drives.

DID THE DIAGNOSTICS PROGRAM CORRECTLY IDENTIFY EACH DRIVE AS "SINGLE SIDED" OR "DOUBLE SIDED?"

Yes No

075

Replace the drive that was not correctly identified.

076

You have successfully completed the Advanced Diagnostic tests. If you suspect an intermittent problem, start an error log. If you need instructions, refer to the Reference manual.

077

(From Steps 010, 022, 039, 043, 048, 052, 068, 087, 095, 098, and 104 in this MAP)

You may have a bad signal cable.

- Power off the system.
- Disconnect the diskette drive signal cable from the drives and the adapter.
- Carefully inspect the cable and cable connectors for damage.
- Inspect the connectors on the adapter and drives for cracks or corrosion.

ARE THE CABLE AND CONNECTORS DEFECT-FREE?

Yes No

078

Replace or repair the defective part.

079

Use the adapter end of the cable to check for shorts.

- Touch one meter probe to pin 1 and the other meter probe to pin 2. The meter should read infinity.
- Check pin 2 to pin 3, pin 3 to pin 4, and so on until all pins have been checked.

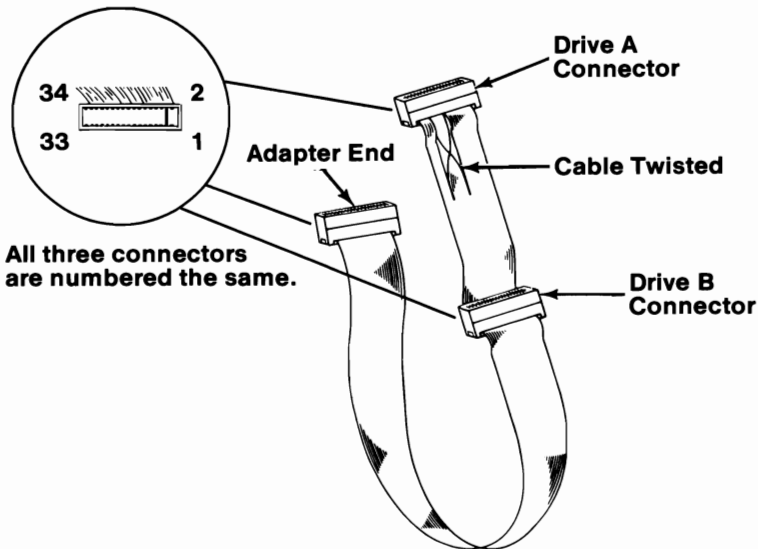

Figure 13. Signal Cable

079 (continued)

IS THE CABLE FREE FROM SHORTS?

Yes No

080

Replace the signal cable.

081

- Refer to Figure 14 and check the signal cable for continuity.

Note: Check the continuity from pin number to pin number except the pins preceded by an asterisk.

Signal Cable Connector							
Even Pins				Odd Pins			
Drive A - Adapter		Drive B - Adapter		Drive A - Adapter		Drive B - Adapter	
2	2	2	2	1	1	1	1
4	4	4	4	3	3	3	3
6	6	6	6	5	5	5	5
8	8	8	8	7	7	7	7
*10	16	10	10	9	9	9	9
*12	14	12	12	*11	15	11	11
*14	12	14	14	13	13	13	13
*16	10	16	16	*15	11	15	15
18	18	18	18	17	17	17	17
20	20	20	20	19	19	19	19
22	22	22	22	21	21	21	21
24	24	24	24	23	23	23	23
26	26	26	26	25	25	25	25
28	28	28	28	27	27	27	27
30	30	30	30	29	29	29	29
32	32	32	32	31	31	31	31
34	34	34	34	33	33	33	33

*Check for continuity between the pins listed.

Figure 14. Continuity Check

DOES THE SIGNAL CABLE HAVE CONTINUITY?

Yes No

082

Replace the signal cable.

083

Replace the diskette drive adapter. If the problem still exists, replace the diskette drive.

084

(From Steps 006 and 013 in this MAP)

- Check for a change in voltage between Test Point H and ground as you slide a diskette in and out of the diskette drive (see the Test Point Reference page).

DID THE VOLTAGE CHANGE AS DESCRIBED ON THE TEST POINT REFERENCE PAGE?

Yes No

|
|
|
|
|

085

Replace the write-protect sensor.

086

- Remove the diskette.
- Check the voltage at pin 28 on the diskette drive logic board.

Note: Use the frame as ground.

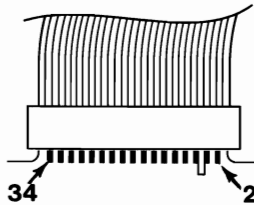

Figure 15. Signal Connector - Pin 28

IS THE VOLTAGE APPROXIMATELY 5 VDC?

Yes No

|
|
|
|
|

087

Go to Step 077 in this MAP.

088

- Power off the system for about 5 seconds.
- Power on the system.
- When the LED lights, monitor the voltage at pin 28 of the diskette drive logic board as you slide a diskette in and out of the drive.

Note: To test drive B, exchange the cables and repeat this step.

WHILE THE LED WAS ON, DID THE VOLTAGE CHANGE FROM APPROXIMATELY 5 VDC TO APPROXIMATELY 0 VDC EACH TIME THE WRITE PROTECT SENSOR OPERATED?

Yes	No
-----	----

	089

	Replace the diskette drive logic board.
--	---

090

Replace the diskette drive adapter.

091

(From Step 013 in this MAP)

- Remove the diskette from the drive.
- Check the voltage between Test Point A and ground while inserting a diskette (see the Test Point Reference page).

Warning: Do not short the pins together when taking this voltage reading; damage to the boards may occur.

DID THE VOLTAGE CHANGE AS DESCRIBED ON THE TEST POINT REFERENCE PAGE?

Yes	No
-----	----

	092

	Replace the diskette drive.
--	-----------------------------

093

- Remove the diskette from the drive.
- Check the voltage between test point B and ground (see the Test Point Reference page).

DID THE VOLTAGE CHANGE AS DESCRIBED ON THE TEST POINT REFERENCE PAGE?

Yes	No
-----	----

	(Step 094 continues)

094

Replace the diskette drive logic board.

095

Go to Step 077 in this MAP.

096

(From Step 073 in this MAP)

- Power off the system.
- Insert the Advanced Diagnostics diskette into drive A.
- Power on the system.
- Run the Diskette Drive and Adapter tests one time. Use the **(RUN TESTS MULTIPLE TIMES)** option.

DO YOU STILL HAVE AN ERROR CODE?

Yes No

097

Run the Advanced Diagnostic tests one more time to verify you have fixed the problem.

098

Go to Step 077 in this MAP.

099

(From Step 013 in this MAP)

ARE TWO DISKETTE DRIVES INSTALLED IN THE SYSTEM?

Yes No

100

Go to Step 105 in this MAP.

101

DID MORE THAN ONE DISKETTE DRIVE ERROR MESSAGE APPEAR?

Yes No

102

Go to Step 105 in this MAP.

(Step 103 continues)

103**ARE THE 6XX ERROR CODES DIFFERENT?**

Yes No

104

Go to Step 077 in this MAP.

105

(From Steps 100 and 102 in this MAP)

- Perform the final drive-motor speed check (see the Test Point Reference page).

Note: Do not adjust the speed until this MAP instructs you to do so.

IS THE SPEED WITHIN THE LIMITS DISPLAYED ON THE SCREEN?

Yes No

106

Go to Step 108 in this MAP.

107

Replace the diskette drive logic board.

108

(From Step 106 in this MAP)

ARE YOU TESTING EITHER A TYPE 1 OR TYPE 2 DRIVE?

Yes No

109

Go to Step 059 in this MAP.

110

- Adjust the drive-motor speed (see the Test Point Reference page).

IS THE SPEED NOW CORRECT?

Yes No

(Step 111 continues)

111

Go to Step 053 in this MAP.

112

- Power off the system.
- Insert the Advanced Diagnostics diskette into drive A.
- Power on the system.
- Run the Diskette Drive and Adapter tests one time. Use the **(RUN TESTS MULTIPLE TIMES)** option.

DO YOU STILL HAVE A 624 ERROR CODE?

Yes No

113

Run the Advanced Diagnostic tests one more time to verify you have fixed the problem.

114

Replace the diskette drive logic board.

(

TEST POINT REFERENCE PAGE

for

TYPE 1 DISKETTE DRIVES

(Drives with a serial number prefix A, B, or no prefix)

(

(

Test Point Reference Chart

Test Point	Location	Specifications
A	P10-2	Decreases from 0.5 Vdc to 0 Vdc while inserting a diskette in the drive.
B	TP-7	Decreases from 5.0 Vdc to 0 Vdc while inserting a diskette in the drive.
C	P9-1 (+)	1.5 Vdc minimum across these two test points.
D	P9-2 (-)	
E	P11-1	0 Vdc before the LED lights.
F	TP-5	As the LED initially lights, the voltage increases by 0.2 Vdc.
G	P21-3	3 Vdc to 12 Vdc with the LED on.
H	P8-1	Increases from 0 Vdc to 5.0 Vdc while inserting a diskette into the drive.

Requested Voltage Reading	Minimum	Maximum
Approximately 0 Vdc	0.0 Vdc	0.8 Vdc
Approximately 0.2 Vdc	0.15 Vdc	0.25 Vdc
Approximately 0.5 Vdc	0.5 Vdc	1.0 Vdc
Approximately 5.0 Vdc	2.0 Vdc	5.5 Vdc
Approximately 12 Vdc	11.2 Vdc	12.6 Vdc

Test Point Locations

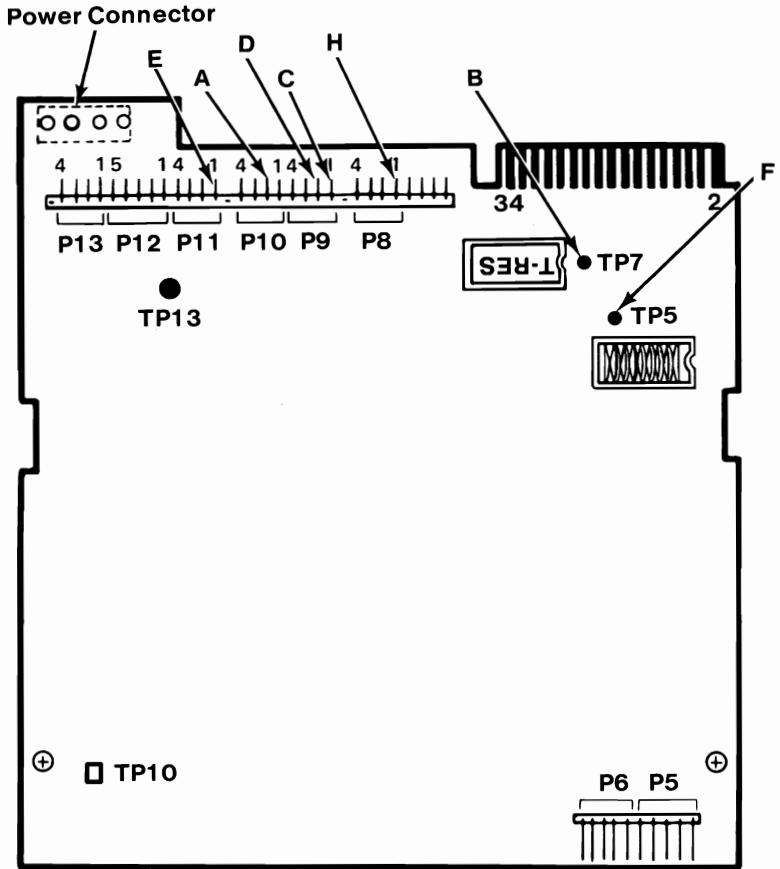

Logic Board

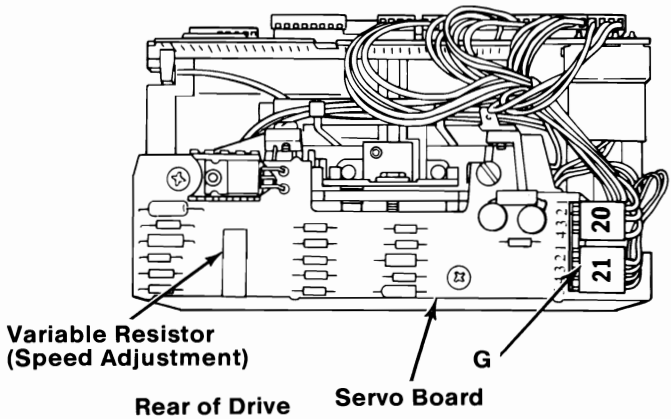

Preliminary Speed Check

1. Remove the diskette drive.
2. Plug the power connector into the diskette drive logic board. Leave the signal cable disconnected.
3. Insert a scratch diskette into the diskette drive.
4. Connect a jumper between TP-10 and TP-13 of the diskette drive logic board.
5. Power on the system.
6. Observe the strobe marks on the drive pulley under fluorescent lighting.

Note: The outer ring is for 60 hertz and the inner ring is for 50 hertz.

If the speed is correct, the appropriate ring of strobe marks will appear to stand still.

Preliminary Speed Adjustment

Adjust the variable resistor on the servo board until the appropriate ring of strobe marks appears to stand still.

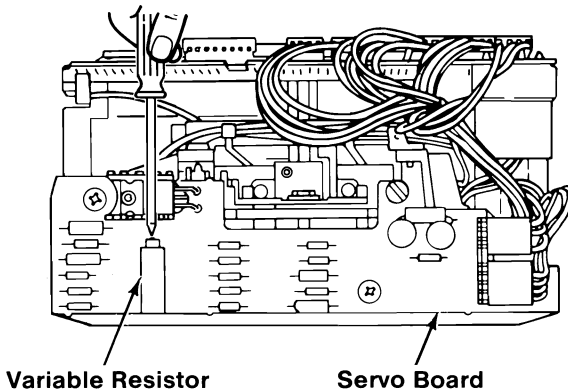

Final Speed Adjustment

1. Power off the system.
2. Insert the Advanced Diagnostic into the diskette drive.
3. Power on the system.
4. Run the Diskette Drive and Adapter tests. Use the **(RUN TESTS MULTIPLE TIMES)** option.
5. When the Diskette Diagnostic menu appears, select option 4, **(SPEED TEST)**.
6. Adjust the variable resistor on the servo board until the speed falls within the range displayed.

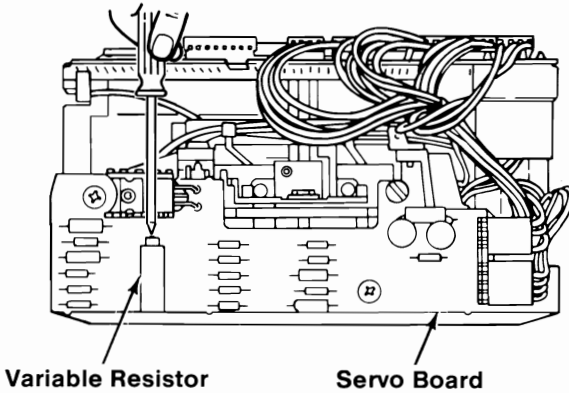

TEST POINT REFERENCE PAGE

for

TYPE 2 DISKETTE DRIVES

(Drives with a serial number prefix D)

Test Point Reference Chart

Test Point	Location	Specifications
A	J2-20	Increases from 0 Vdc to 5.0 Vdc while inserting a diskette in the drive.
B	U6 Pin 5	Decreases from 5.0 Vdc to 0 Vdc while inserting a diskette in the drive.
C	J3-16 (+)	1.5 Vdc minimum across these two test points.
D	J3-15 (-)	
E	J3-24	0 Vdc before the LED lights.
F	U6 Pin 1	As the LED initially lights, the voltage increases by 0.2 Vdc.
G	J3-3	3 Vdc to 12 Vdc with the LED on.
H	J3-14	Decreases from 5.0 Vdc to 0 Vdc while inserting a diskette into the drive.

Requested Voltage Reading	Minimum	Maximum
Approximately 0 Vdc	0.0 Vdc	0.8 Vdc
Approximately 0.2 Vdc	0.15 Vdc	0.25 Vdc
Approximately 0.5 Vdc	0.5 Vdc	1.0 Vdc
Approximately 5.0 Vdc	2.0 Vdc	5.5 Vdc
Approximately 12 Vdc	11.2 Vdc	12.6 Vdc

Test Point Locations

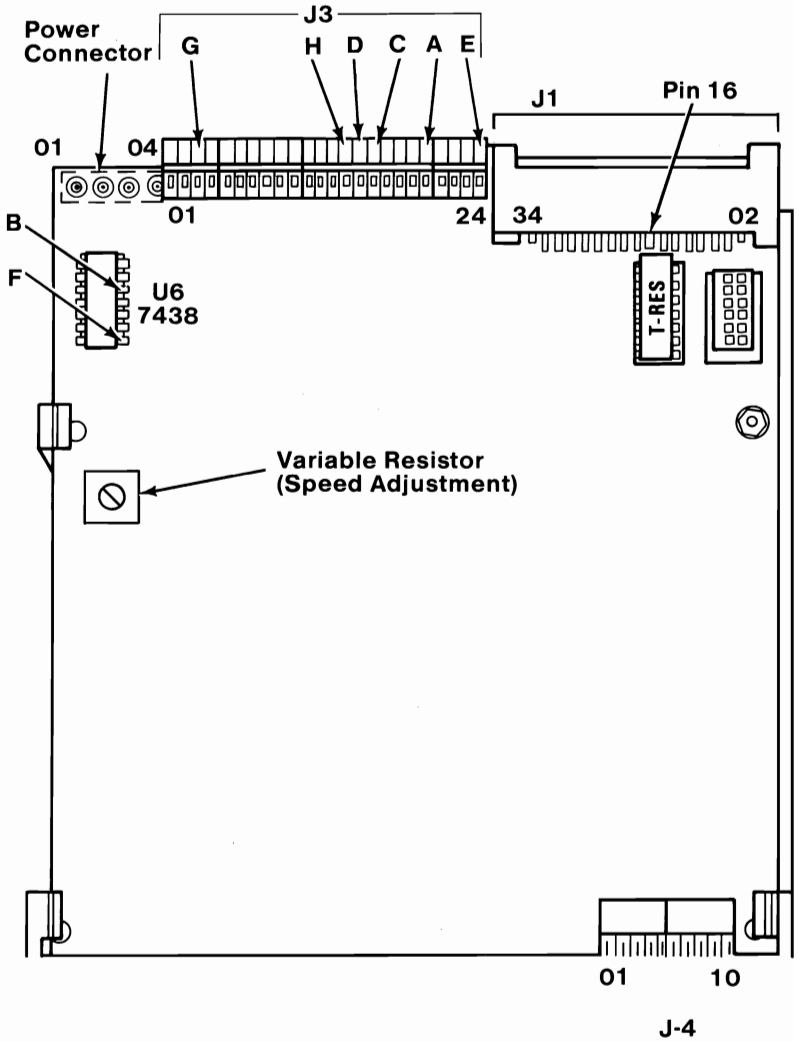

Preliminary Speed Check

1. Remove the diskette drive.
2. Plug the power connector into the diskette drive logic board. Leave the signal cable disconnected.
3. Insert a scratch diskette into the diskette drive.
4. Connect a jumper between pin 16 of the diskette drive signal connector and ground (use the frame as ground).
5. Power on the system.
6. Observe the strobe marks on the drive pulley under fluorescent lighting.

Note: The outer ring is for 60 hertz and the inner ring is for 50 hertz.

If the speed is correct, the appropriate ring of strobe marks will appear to stand still.

Preliminary Speed Adjustment

Adjust the variable resistor on the diskette drive logic board until the appropriate ring of strobe marks appears to stand still.

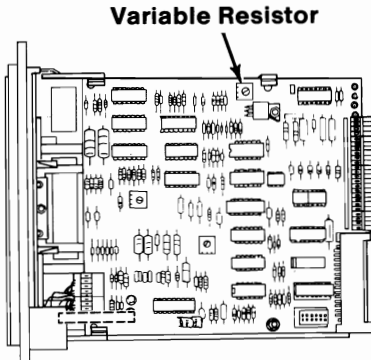

Final Speed Adjustment

1. Power off the system.
2. Insert the Advanced Diagnostic diskette into drive A.
3. Power on the system.
4. Run the Diskette Drive and Adapter test using the **(RUN TESTS MULTIPLE TIMES)** option.
5. When the Diskette Diagnostic menu appears, select option 4, **(SPEED TEST)**.
6. Adjust the variable resistor on the diskette drive logic board until the speed falls within the range displayed.

Variable Resistor

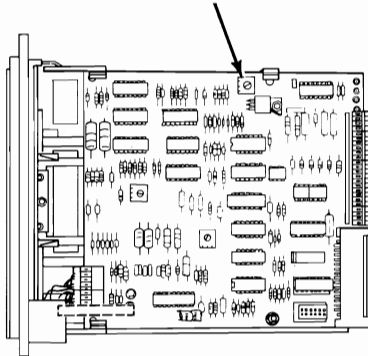

(

TEST POINT REFERENCE PAGE

for

TYPE 3 DISKETTE DRIVES

(Drives with a serial number prefix E)

(

(

Test Point Reference Chart

Test Point	Location	Specifications
A	J6-2	5.0 Vdc with the diskette removed and the latch closed.
B	U10-4	Do the following: <ol style="list-style-type: none"> 1. Insert a diskette into drive A. 2. Power off the system for 5 seconds. 3. Power on the system. 4. With the diskette inserted and the latch closed, a fluctuation of approximately 0.1 Vdc will occur after the beep at the end of the POST and will continue for as long as the spindle rotates.
C	P7-1 (+)	1.5 Vdc minimum across these two test points.
D	P7-2 (-)	
E	N/A	Go to Step 038.
F	TP-1	As the LED initially lights, the voltage decreases by 0.2 Vdc.
G	P9-3	3 Vdc to 12 Vdc with the LED on.
H	P4-2	Decreases from 5.0 Vdc to 0 Vdc while inserting a diskette into the drive.

Requested Voltage Reading	Minimum	Maximum
Approximately 0 Vdc	0.0 Vdc	0.8 Vdc
Approximately 0.2 Vdc	0.15 Vdc	0.25 Vdc
Approximately 0.5 Vdc	0.5 Vdc	1.0 Vdc
Approximately 5.0 Vdc	2.0 Vdc	5.5 Vdc
Approximately 12 Vdc	11.2 Vdc	12.6 Vdc

Test Point Locations

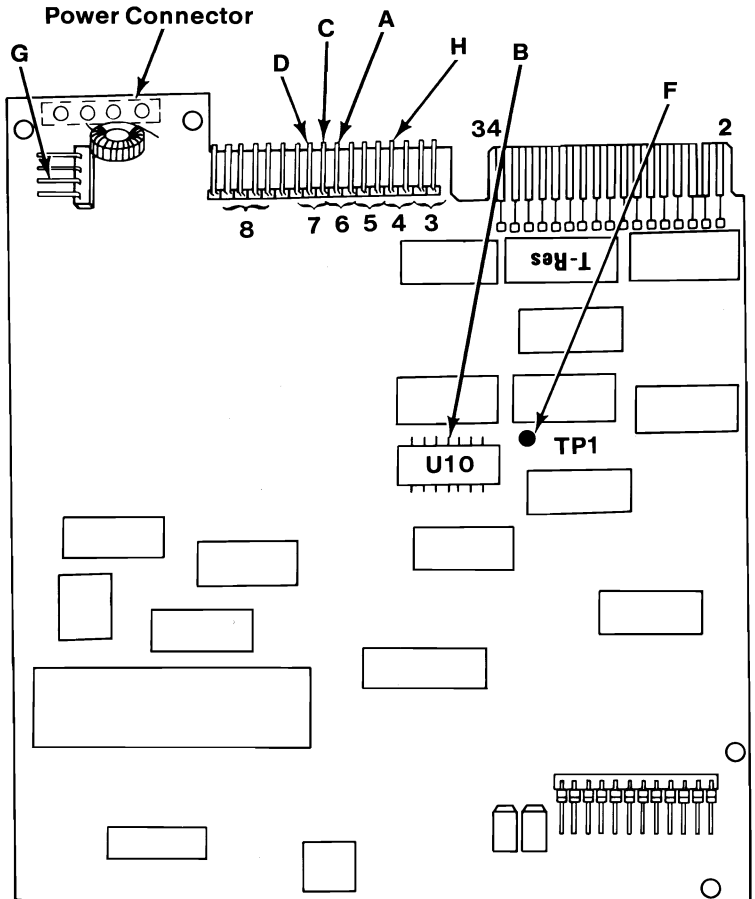

Preliminary Speed Check

1. Remove the diskette drive.
2. Plug the power connector into the diskette drive logic board. Leave the signal cable disconnected.
3. Insert a scratch diskette into the diskette drive.
4. Connect a jumper between pin 16 of the diskette drive signal connector and ground (use the frame as ground).
5. Power on the system.
6. Observe the strobe marks on the drive pulley under fluorescent lighting.

Note: The outer ring is for 60 hertz and the inner ring is for 50 hertz.

7. If the speed is correct, the appropriate ring of strobe marks will appear to stand still.

The Type 3 diskette drive monitors its own speed and compensates accordingly. There are no speed adjustments on the drive. If the speed is not correct, an electrical or mechanical problem exists. Return to the MAP to isolate the failure.

Final Speed Check

1. Power off the system.
2. Insert the Advanced Diagnostic diskette into drive A.
3. Power on the system.
4. Run the Diskette Drive and Adapter test using the **(RUN TESTS MULTIPLE TIMES)** option.
5. When the Diskette Diagnostic menu appears, select option 4, **(SPEED TEST)**.
6. The speed should fall within the range displayed.

The Type 3 diskette drive monitors its own speed and compensates accordingly. There are no speed adjustments on the drive. If the speed is not correct, an electrical or mechanical problem exists. Return to the MAP to isolate the failure.

MAP 0600: Diskette Drive (Portable PC)

Symptom Explanation	Conditions That Could Cause This Symptom
You have entered this MAP because you received a 6XX error code, or you have been directed here from another MAP.	<ul style="list-style-type: none">• A diskette drive is failing.• The diskette drive adapter is failing.

When checking voltages in this MAP:

- Use the system unit's frame as ground.
- "Approximately 5 Vdc" = 2.0 to 5.5 Vdc
- "Approximately 0 Vdc" = 0 to 0.8 Vdc

The terminating resistor must always be installed on drive A. Drive B should not have a terminating resistor installed.

001

- Check to see that your diskette is free of damage, is formatted, and is inserted correctly.

IS YOUR DISKETTE FREE OF DAMAGE, FORMATTED, AND INSERTED CORRECTLY?

Yes No

|

002

Use another diskette or insert the diskette correctly, then go to "MAP 0000: Start (PC)" and follow the MAP to verify that your system is operating correctly.

003

ARE TWO DISKETTE DRIVES INSTALLED IN THE SYSTEM?

Yes No

|

(Step 004 continues)

004

Go to Step 011 in this MAP.

005

DOES THE FAILURE OCCUR ON DRIVE A?

Yes No

|

006

Go to Step 011 in this MAP.

007

- Remove the system unit cover.
- Remove the signal cable from diskette drive B.
- Remove the signal cable from diskette drive A and install it on diskette drive B.
- Power on the system.
- Retry the failing operation on diskette drive B.

DOES THE SAME FAILURE OCCUR ON DISKETTE DRIVE B AS ON DISKETTE DRIVE A?

Yes No

|

008

Go to Step 010 in this MAP.

009

Go to Step 057 in this MAP.

010

(From Step 008 in this MAP)

- Power off the system.
 - Remove the signal cable from diskette drive B and install it on diskette drive A.
 - Install the diskette drive B signal connector on diskette drive B, then go to Step 011 in this MAP.
-

011

(From Steps 004, 006, 010, and 035 in this MAP)

- Power off the system.
 - Insert your Advanced Diagnostics diskette into drive A.
- (Step 011 continues)

011 (continued)

- Power on the system.
- Observe the light-emitting diode (LED) on drive A.

DID THE LED ON DISKETTE DRIVE A LIGHT JUST BEFORE THE BEEP AT THE END OF POST?**Yes** **No****012**

Go to Step 022 in this MAP.

013**DID THE ADVANCED DIAGNOSTICS MENU APPEAR?****Yes** **No****014**

Go to Step 027 in this MAP.

015**DO YOU HAVE A FORMATTED DISKETTE FOR EACH DRIVE?****Yes** **No****016**

Go to Step 018 in this MAP.

017

Go to Step 019 in this MAP.

018

(From Step 016 in this MAP)

- Press 1 (**FORMAT DISKETTE**), then press Enter.
- Follow the instructions on your screen and format a diskette to be used as a scratch diskette, then go to Step 019 in this MAP.

Note: If two diskette drives are installed in the system unit, format two scratch diskettes.

019

(From Steps 017 and 018 in this MAP)

- Run the Diskette Drive and Adapter tests. Use the **(RUN TESTS MULTIPLE TIMES)** option.

DID YOU RECEIVE AN ERROR CODE ON THE SCREEN?

Yes No

020

Go to Step 036 in this MAP.

021

The fourth character of message line 2, as shown in Figure 1, indicates which diskette drive is failing. If the character is 0, drive A is failing. If the character is 1, drive B is failing.

- Make a note of the error code and the fourth character on your screen.

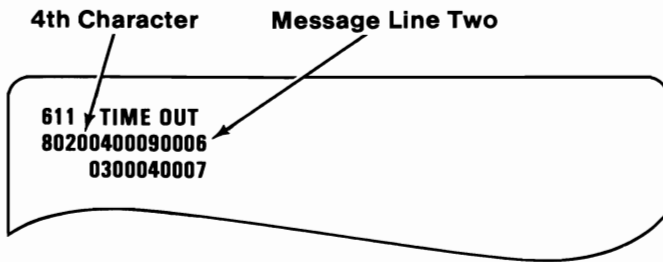

Figure 1. Error Message

- Format another diskette using the failing drive. Make a note of the error code.
- Find your error code in Figure 2 on page 0600-5 and take the action described.

Error Code	Action
606.....	Go to Step 054 in this MAP
607.....	Go to Step 049 in this MAP
608.....	Replace the Diskette Drive
611.....	Go to Step 054 in this MAP
612.....	Go to Step 046 in this MAP
613.....	Go to Step 046 in this MAP
621.....	Go to Step 052 in this MAP
622.....	Go to Step 052 in this MAP
623.....	Go to Step 052 in this MAP
624.....	Go to Step 052 in this MAP
625.....	Go to Step 052 in this MAP
626.....	Go to Step 052 in this MAP

Figure 2. Error Codes

022

(From Step 012 in this MAP)

- Remove the system unit cover.
- Check the power connector on the diskette drive for the voltages listed in Figure 3. If two diskette drives are installed, measure the voltages at both drives.

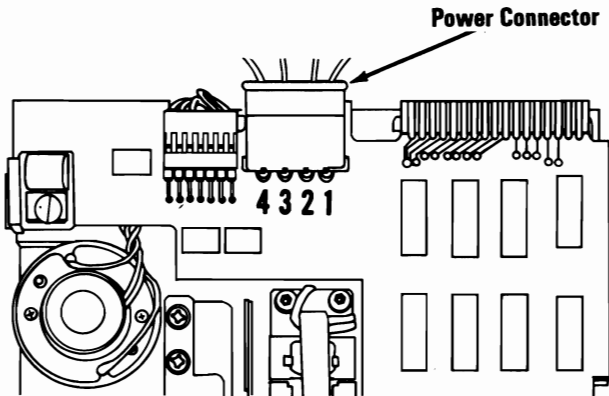

Diskette Drive Power Connector			
Min Vdc	Max Vdc	-Lead	+Lead
+ 4.8	+ 5.25	3	4
+11.52	+12.6	2	1

Figure 3. Voltage Check

022 (continued)

ARE THE VOLTAGES CORRECT?

Yes No

023

Go to "MAP 0020: Power Start."

024

- Power off the system for at least 5 seconds.
- Power on the system.
- Monitor the voltage between pin 12 of the signal cable connector and ground. The voltage should decrease from approximately 5 Vdc at the start of the POST to approximately 0 Vdc before the beep at the end of the POST.

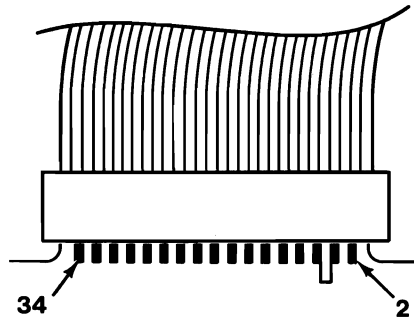

Figure 4. Voltage Check

DID THE VOLTAGE DECREASE TO APPROXIMATELY 0 VDC BEFORE THE BEEP AT THE END OF POST?

Yes No

025

Replace the diskette drive adapter.

026

Replace the diskette drive.

027

(From Step 014 in this MAP)

- Remove the Advanced Diagnostics diskette.
- Power off the system.
- Remove the failing diskette drive.
- Install the power and signal connectors on the diskette drive.
- Power on the system.
- Observe the spindle during the POST.

DID THE SPINDLE BEGIN TO ROTATE BEFORE THE BEEP AT THE END OF POST?

Yes No

|

|

028

Go to Step 039 in this MAP.

029

- Perform the diskette-drive-motor preliminary speed test.

Note: You need a fluorescent light to see the strobe effect of this test.

IS THE SPEED OF THE DRIVE CORRECT?

Yes No

|

|

030

Adjust the variable resistor for the proper speed. If you are unable to adjust the speed satisfactorily, replace the diskette drive.

031

- Power off the system.
- Measure the voltage between pin 26 of the signal cable connector and ground, as shown in Figure 5 on page 0600-8.
- Power on the system.
- Ensure the voltage is between approximately 2.0 and 5.0 Vdc at the start of the POST.

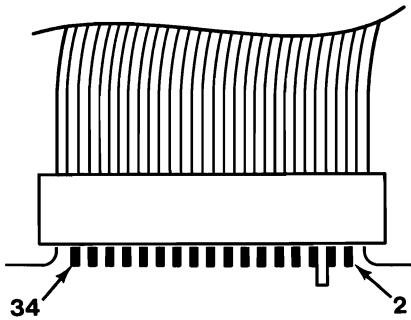

Figure 5. Voltage Check

WAS THE VOLTAGE BETWEEN PIN 26 AND GROUND APPROXIMATELY 5 VDC AT THE START OF POST?

Yes No

032

Go to Step 046 in this MAP.

033

- Power off the system for at least 5 seconds.
- Ensure that a terminating resistor is installed in diskette drive A only.
- Power on the system.
- Monitor the voltage between pin 18 and ground during the POST.

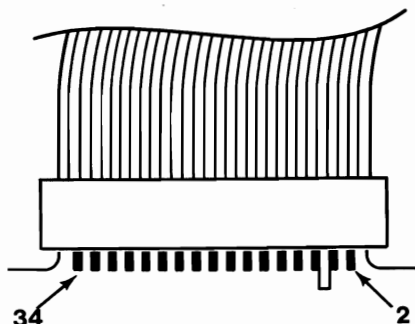

Figure 6. Voltage Check

DID THE VOLTAGE BETWEEN PIN 18 AND GROUND GO FROM 5 VDC TO 0 VDC AND BACK TO 5 VDC BEFORE THE BEEP AT THE END OF POST?

Yes No

|

|

034
Go to Step 046 in this MAP.

035

Replace the diskette drive and go to Step 011 in this MAP to verify proper diskette drive operation. If this is your second time at this point and your problem still exists, replace the diskette drive adapter.

036

(From Step 020 in this MAP)

Portable PC diskette drives are double-sided drives.

(Step 036 continues)

036 (continued)

DID THE DIAGNOSTIC TESTS CORRECTLY IDENTIFY THE DRIVES AS "DOUBLE SIDED?"

Yes No

|
|
037

Replace the diskette drive that is identified as "single sided" in the message.

038

You have successfully completed the Advanced Diagnostic tests. If you suspect an intermittent problem, start an error log. If you need instructions, refer to the Reference manual.

039

(From Steps 028 and 050 in this MAP)

IS THE DISKETTE DRIVE BELT INSTALLED ON THE PULLEYS CORRECTLY AND IN GOOD CONDITION?

Yes No

|
|
040

Replace the drive belt.

041

- Check the power connector on the diskette drive for the voltages listed in Figure 7 on page 0600-11. If two diskette drives are installed, the voltages listed in the figure apply to both.

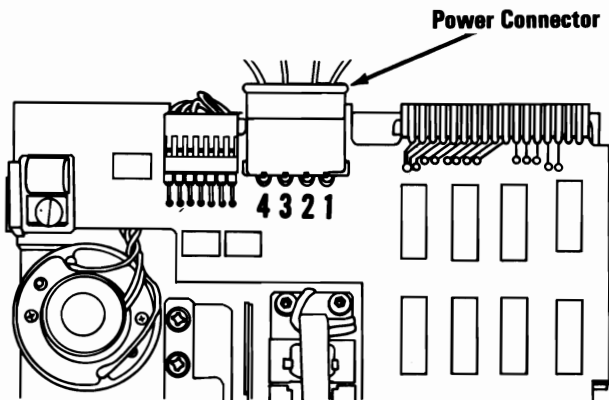

Diskette Drive Power Connector			
Min Vdc	Max Vdc	-Lead	+Lead
+ 4.8	+ 5.25	3	4
+11.52	+12.6	2	1

Figure 7. Voltage Check

ARE THE VOLTAGES WITHIN THE LIMITS INDICATED (Figure 7)?

Yes No

042

Go to "MAP 0020: Power Start."

043

- Power off the system for at least 5 seconds.
- Power on the system.
- Monitor the voltage between pin 16 of the signal cable connector and ground.
- The voltage should decrease from approximately 5.0 Vdc at the start of the POST to approximately 0 Vdc before the beep at the end of the POST.

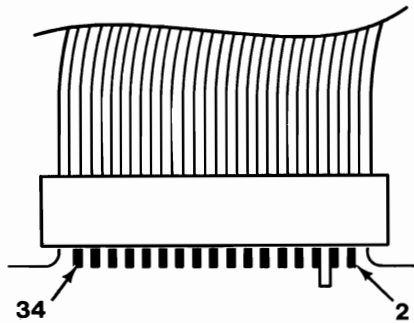

Figure 8. Voltage Check

DID THE VOLTAGE BETWEEN PIN 16 AND GROUND DECREASE TO APPROXIMATELY 0 VDC?

Yes

No

044

Go to Step 046 in this MAP.

045

Replace the diskette drive.

046

(From Steps 021, 032, 034, and 044 in this MAP)

Check the continuity of the diskette-drive cable as follows:

- Power off the system.
- Set your meter to the Ohms X 1 scale.
- Refer to Figure 9 on page 0600-13 to locate the test points on the signal cable.

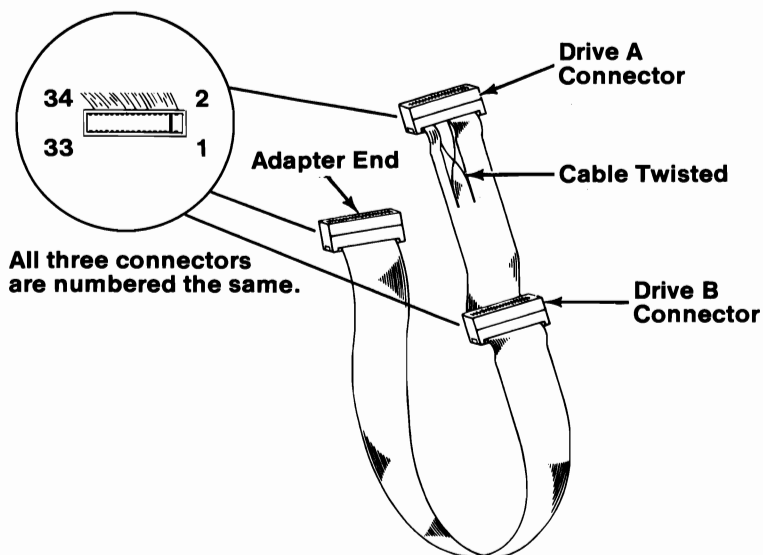

Figure 9. Signal Cable Pin Locations

- Refer to Figure 10 on page 0600-14 and check the continuity of the signal cable.
- Check for continuity from pin number to pin number except for those numbers preceded by an asterisk.

Signal Cable Connector							
Even Pins				Odd Pins			
Drive A - Adapter		Drive B - Adapter		Drive A - Adapter		Drive B - Adapter	
2	2	2	2	1	1	1	1
4	4	4	4	3	3	3	3
6	6	6	6	5	5	5	5
8	8	8	8	7	7	7	7
*10	16	10	10	9	9	9	9
*12	14	12	12	*11	15	11	11
*14	12	14	14	13	13	13	13
*16	10	16	16	*15	11	15	15
18	18	18	18	17	17	17	17
20	20	20	20	19	19	19	19
22	22	22	22	21	21	21	21
24	24	24	24	23	23	23	23
26	26	26	26	25	25	25	25
28	28	28	28	27	27	27	27
30	30	30	30	29	29	29	29
32	32	32	32	31	31	31	31
34	34	34	34	33	33	33	33

*Check for continuity between the pins listed.

Figure 10. Pin Numbers

IS THE CONTINUITY OF THE SIGNAL CABLE CORRECT?

Yes No

047

Replace the signal cable.

048

Replace the diskette drive and go to Step 001 in this MAP. If this is your second time at this point and your problem still exists, replace the diskette drive adapter.

049

(From Step 021 in this MAP)

- Power off the system for at least 5 seconds.
- Power on the system.
- When the LED lights, monitor the voltage between pin 28 of the signal cable connector and ground as you slide a diskette in and out of the drive. The voltage should decrease from approximately 5 Vdc to approximately 0 Vdc each time the write protect switch operates.

Note: If diskette drive B is being tested, exchange the signal cable connectors with diskette drive A.

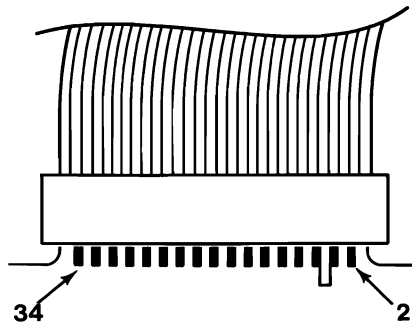

Figure 11. Signal Cable Connector

DID THE VOLTAGE DECREASE FROM APPROXIMATELY 5.0 VDC TO 0 VDC EACH TIME THE WRITE-PROTECT SWITCH WAS OPERATED WHILE THE LED WAS ON?

Yes No

050

If approximately 5.0 Vdc was never present, go to Step 039 in this MAP. If the voltage did not decrease from approximately 5.0 Vdc to 0 Vdc, replace the diskette drive.

051

Replace the diskette drive adapter.

052

(From Step 021 in this MAP)

- Perform the diskette-drive-motor preliminary speed test.

Note: You need a fluorescent light to see the strobe effect of this test.

(Step 052 continues)

052 (continued)

IS THE SPEED OF THE DRIVE CORRECT?

Yes No

053

Adjust the speed of the diskette drive. If you are unable to adjust the diskette drive speed satisfactorily, go to Step 054 in this MAP.

054

(From Steps 021 and 053 in this MAP)

Check the continuity of the diskette-drive cable as follows:

- Power off the system.
- Disconnect the diskette drive signal cable from the diskette drive adapter and the diskette drive.
- Set your meter to the Ohms X 1 scale.
- Refer to Figure 12 for the test points on the signal cable.

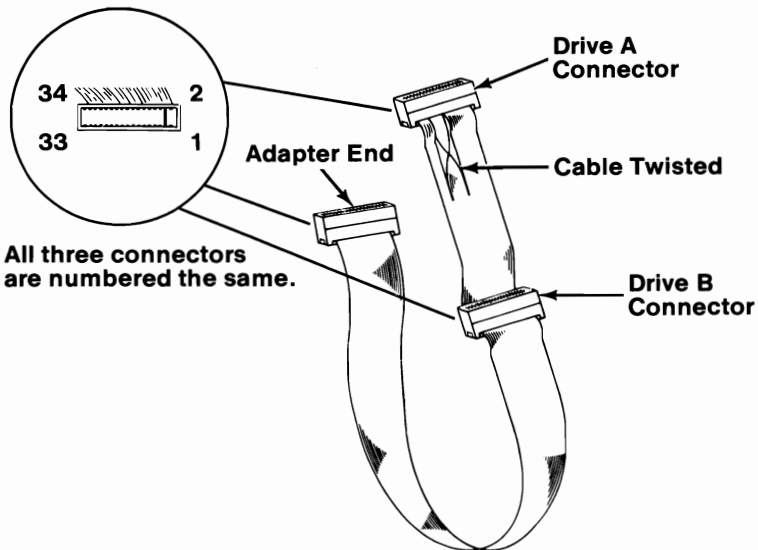

Figure 12. Signal Cable

054 (continued)

- Refer to Figure 13. Check signal cable continuity from pin number to pin number, except for those numbers preceded by an asterisk.

Signal Cable Connector							
Even Pins				Odd Pins			
Drive A - Adapter		Drive B - Adapter		Drive A - Adapter		Drive B - Adapter	
2	2	2	2	1	1	1	1
4	4	4	4	3	3	3	3
6	6	6	6	5	5	5	5
8	8	8	8	7	7	7	7
*10	16	10	10	9	9	9	9
*12	14	12	12	*11	15	11	11
*14	12	14	14	13	13	13	13
*16	10	16	16	*15	11	15	15
18	18	18	18	17	17	17	17
20	20	20	20	19	19	19	19
22	22	22	22	21	21	21	21
24	24	24	24	23	23	23	23
26	26	26	26	25	25	25	25
28	28	28	28	27	27	27	27
30	30	30	30	29	29	29	29
32	32	32	32	31	31	31	31
34	34	34	34	33	33	33	33

*Check for continuity between the pins listed.

Figure 13. Continuity Check

IS THE CONTINUITY OF THE SIGNAL CABLE CORRECT?

Yes No

055

Replace the signal cable.

056

Replace the diskette drive and go to Step 001 in this MAP. If this is your second time at this point and your problem still exists, replace the diskette drive adapter.

057

(From Step 009 in this MAP)

Check the continuity of the diskette-drive cable as follows:

- Power off the system.
- Disconnect the diskette drive signal cable from the diskette drive adapter and the diskette drive.

(Step 057 continues)

057 (continued)

- Set your meter to the Ohms X 1 scale.
- Refer to Figure 14 for the test points on the signal cable.

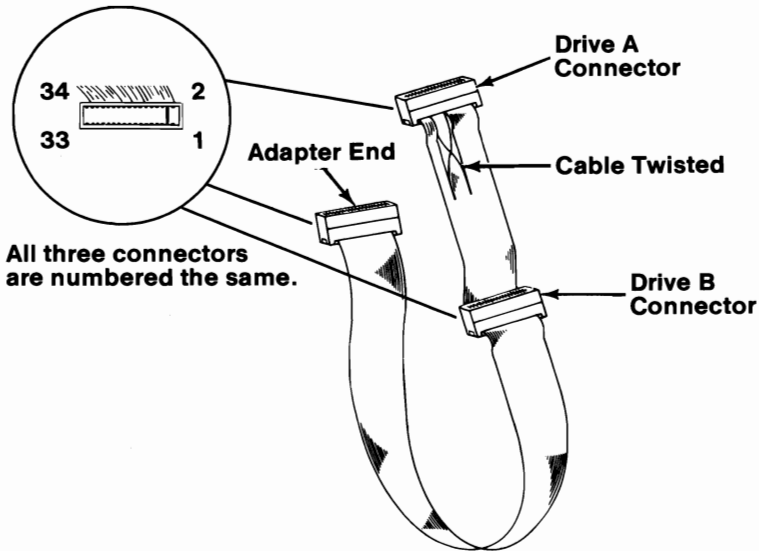

Figure 14. Signal Cable

- Refer to Figure 15 on page 0600-19 and check the continuity of the signal cable.
- Check continuity from pin number to pin number, except for those numbers preceded by an asterisk.

Signal Cable Connector							
Even Pins				Odd Pins			
Drive A - Adapter		Drive B - Adapter		Drive A - Adapter		Drive B - Adapter	
2	2	2	2	1	1	1	1
4	4	4	4	3	3	3	3
6	6	6	6	5	5	5	5
8	8	8	8	7	7	7	7
*10	16	10	10	9	9	9	9
*12	14	12	12	*11	15	11	11
*14	12	14	14	13	13	13	13
*16	10	16	16	*15	11	15	15
18	18	18	18	17	17	17	17
20	20	20	20	19	19	19	19
22	22	22	22	21	21	21	21
24	24	24	24	23	23	23	23
26	26	26	26	25	25	25	25
28	28	28	28	27	27	27	27
30	30	30	30	29	29	29	29
32	32	32	32	31	31	31	31
34	34	34	34	33	33	33	33

*Check for continuity between the pins listed.

Figure 15. System Board Identification

IS THE CONTINUITY OF THE SIGNAL CABLE CORRECT?

Yes No

058

Replace the signal cable.

059

Replace the diskette drive adapter.

Notes:



MAP 0600: Diskette Drive (AT)

Symptom Explanation	Conditions That Could Cause This Symptom
You have entered this MAP because you received a 6XX error code, or you have been directed here from another MAP.	<ul style="list-style-type: none">• The diskette drive is failing.• The diskette drive adapter is failing.• The system board is failing.• The diskette drive signal cable is failing.• The power supply is failing.

Notes:

1. Within this MAP, the term "scratch diskette" refers to a blank formatted diskette that is **not write protected**.
2. A double-sided (360K) diskette cannot be formatted in a High-Capacity (1.2M) diskette drive using the Advanced Diagnostics format routine.

001

(From Steps 035 and 037 in this MAP)

- Power off the system.
- Ensure the terminating resistor is correctly installed or the terminating switches are correctly set for each installed diskette drive.

Terminating Resistors - A terminating resistor must be installed on diskette drive A. Diskette drive B should not have a terminating resistor installed.

Terminating Switches - Terminating Switches must be set to the On position for diskette drive A and the Off position for diskette drive B.

- Insert the Advanced Diagnostics diskette into drive A.
 - Power on the system.
- (Step 001 continues)

001 (continued)

- You may receive an error during the POST. Disregard the error and press **F1** to continue with the POST.

DID THE LED ON EACH INSTALLED DISKETTE DRIVE LIGHT BEFORE THE BEEP AT THE END OF THE POST?

Yes No

|

|

002

Go to Step 078 in this MAP.

003

IS THE LED ON ANY INSTALLED DISKETTE DRIVE LIT CONSTANTLY?

Yes No

|

|

004

Go to Step 006 in this MAP.

005

Go to Step 088 in this MAP.

006

(From Step 004 in this MAP)

IS THE ADVANCED DIAGNOSTICS MENU DISPLAYED?

Yes No

|

|

007

Try using your backup copy of the Advanced Diagnostics diskette. If you are still unable to load the Advanced Diagnostics program, go to Step 095 in this MAP.

008

- Select **0 (SYSTEM CHECKOUT)**.
- Select the Diskette Drives and Adapter tests. Use the **(RUN TESTS ONE TIME)** option.

Note: Do not run the individual tests until instructed to do so by this MAP.

(Step 008 continues)

008 (continued)

DID THE DISKETTE DIAGNOSTIC MENU APPEAR WITHOUT AN ERROR?

Yes No

|

009

Go to Step 033 in this MAP.

010

- Press **5 (DSKT CHANGE TEST)** then press **Enter**.
- Follow the instructions to run the Diskette Change test on each installed High-Capacity (1.2M) Diskette Drive.

DID YOU RECEIVE A MESSAGE INDICATING A DISKETTE CHANGE ERROR?

Yes No

|

011

Go to Step 013 in this MAP.

012

Go to Step 118 in this MAP.

013

(From Step 011 in this MAP)

- Run the speed test on each diskette drive.

Note: If the speed does not appear on the display within 30 seconds when attempting to test drive B, go to Step 112 in this MAP.

DID YOU RECEIVE AN ERROR MESSAGE DURING THE SPEED TEST?

Yes No

|

014

Go to Step 027 in this MAP.

015

(Step 015 continues)

015 (continued)

WAS THE ERROR MESSAGE 607?

Yes No

|
|
| **016**

Go to Step 018 in this MAP.

017

Go to Step 060 in this MAP.

018

(From Step 016 in this MAP)

ARE TWO DISKETTE DRIVES INSTALLED?

Yes No

|
|
| **019**

Go to Step 024 in this MAP.

020

DID YOU RECEIVE THE ERROR ON BOTH DISKETTE DRIVES?

Yes No

|
|
| **021**

Go to Step 070 in this MAP.

022

- Power off the system.
- Disconnect the signal cable from diskette drive B.
- Power on the system.
- Run the Diskette Drives and Adapter tests. Use the **(RUN TESTS ONE TIME)** option.
- When the Diskette Diagnostic menu appears, perform the speed test on diskette drive A.

DID YOU RECEIVE AN ERROR MESSAGE DURING THE SPEED TEST?

Yes No

|
|
| **023**

(Step 023 continues)

023 (continued)
Replace diskette drive B.

024

(From Step 019 in this MAP)

- Power off the system.
- Disconnect the signal cable from diskette drive A.
- Power on the system and check the voltage at pin 8 of the signal cable (diskette drive end) as shown in Figure 1. The voltage should be 2.0 to 5.5 Vdc.

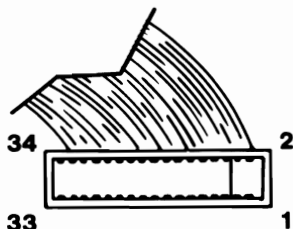

Figure 1. Signal Cable Voltage Check

IS THE VOLTAGE CORRECT?

Yes No

025

Go to Step 130 in this MAP.

026

Replace diskette drive A.

027

(From Step 014 in this MAP)

IS THE SPEED OF EACH DISKETTE DRIVE CORRECT?

Yes No

028

Replace the diskette drive with the incorrect speed.

029

(Step 029 continues)

029 (continued)

- Power off the system.
- Ensure the Advanced Diagnostics diskette is in diskette drive A.
- Power on the system.
- Use the Advanced Diagnostics format option and try to format a **write-protected** diskette in each diskette drive.

DID YOU RECEIVE AN ERROR FROM EACH DISKETTE DRIVE INDICATING THE DISKETTE WAS WRITE PROTECTED?

Yes No

030

Go to Step 060 in this MAP.

031

- Power off the system.
- Ensure the Advanced Diagnostics diskette is in diskette drive A.
- Ensure all cables and connectors are properly connected.
- Power on the system.
- When the Advanced Diagnostics menu appears, select **0 (SYSTEM CHECKOUT)**.
- Run the Diskette Drive and Adapter tests one time. Use the **(RUN TESTS MULTIPLE TIMES)** option.

DID YOU RECEIVE AN ERROR?

Yes No

032

You have successfully completed the Advanced Diagnostics tests. If you suspect an intermittent problem start an error log. If you need instructions, refer to the Reference manual.

033

(From Step 009 in this MAP)

IS THE ERROR CODE 602, 603, 608, or 614?

Yes No

(Step 034 continues)

034

Go to Step 036 in this MAP.

035

A **608** or **614** error code indicates that your Advanced Diagnostics diskette may be defective. A **602** or **603** error code indicates that you have a defective diskette or incorrect type of diskette installed in one of the diskette drives. Replace the failing diskette and return to Step 001 in this MAP.

036

(From Step 034 in this MAP)

- Repeat the Advanced Diagnostic tests using another formatted diskette in the failing diskette drive.

DID YOU RECEIVE AN ERROR?

Yes No

|

037

Your first diskette was defective. Return to Step 001 in this MAP to verify system operation.

038**ARE TWO DISKETTE DRIVES INSTALLED?**

Yes No

|

039

Go to Step 045 in this MAP.

040**IS DISKETTE DRIVE A FAILING?**

Yes No

|

041

Go to Step 045 in this MAP.

042

- Power off the system.
- Disconnect the signal cable from diskette drive B.
- Power on the system.

(Step 042 continues)

042 (continued)

- When the Advanced Diagnostics menu appears select **4 (RUN SETUP)**. Change the setup options to indicate one diskette drive is installed.
- Repeat the Diskette Drive and Adapter tests one time. Use the **(RUN TESTS MULTIPLE TIMES)** option.

DID YOU RECEIVE AN ERROR?

Yes No

043

Replace diskette drive B.

Note: Be sure to run the Setup program. Reset the setup options to indicate two diskette drives are installed.

044

- Make a note of the error code.
- Power off the system
- Reconnect the signal cable to diskette drive B.
- Power on the system.
- When the Advanced Diagnostics menu appears select **4 (RUN SETUP)**. Change the setup options to indicate that two diskette drives are installed.

Go to Step 045 in this MAP

045

(From Steps 039, 041, and 044 in this MAP)

- Find your error code in the following figure and take the action indicated.

Error Code	Action
601 606	Go to Step 130 in this MAP
607	Go to Step 060 in this MAP
612 613 621 622 623 625	Go to Step 130 in this MAP
626	Go to Step 053 in this MAP
624	Go to Step 046 in this MAP

Figure 2. Error Messages

046

(From Step 045 in this MAP)

ARE TWO DISKETTE DRIVES INSTALLED?

Yes No

|

|

047

Replace the diskette drive.

048**DID YOU RECEIVE THE ERROR ON BOTH DISKETTE DRIVES?**

Yes No

|

|

049

Replace the failing diskette drive.

050

(Step 050 continues)

050 (continued)

ARE BOTH ERRORS THE SAME?

Yes No

051

Replace the diskette drive with the **624** error.

052

Go to Step 130 in this MAP.

053

(From Step 045 in this MAP)

- Power off the system for approximately 10 seconds.
- Power on the system and check the voltage at pin 30 on the diskette drive circuit board (Figure 3).

The voltage should be approximately 5 Vdc at the start of the POST and decrease by approximately 0.5 Vdc when the diskette drive LED is on during the POST.

Note: "Approximately 5 Vdc" includes a range of 2.0 to 5.5 Vdc; "approximately 0.5 Vdc" includes a range of 0.3 to 1.0 Vdc.

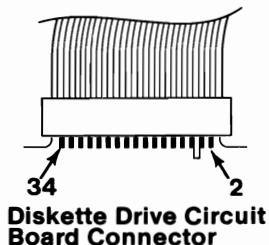

Figure 3. Voltage Check

DID THE VOLTAGE DECREASE BY APPROXIMATELY 0.5 VDC?

Yes No

054

Replace the failing diskette drive.

Note: You must format the scratch diskette before running the diagnostic procedures again.

(Step 055 continues)

055 (continued)

- Power off the system.
- Disconnect the signal cable from the failing diskette drive.
- Power on the system.
- Check the voltage at pin 24 on the diskette drive circuit board (Figure 4). Use the system unit frame as ground.



Figure 4. Voltage Check

IS THE VOLTAGE 2.0 TO 5.5 VDC?

Yes	No
	056
	Replace the diskette drive.

057

- Power off the system.
- Reconnect the diskette drive signal cable.
- Power on the system and monitor the voltage at pin 24 on the diskette drive circuit board (Figure 5 on page 0600-12).

Note: "Approximately 5 Vdc" includes a range of 2.0 to 5.5 Vdc.

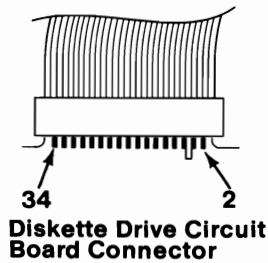

Figure 5. Voltage Check

IS THE VOLTAGE APPROXIMATELY 5.0 VDC AT THE START OF THE POST?

Yes No

058

Go to Step 130 in this MAP.

059

Replace the failing diskette drive.

060

(From Steps 017, 030, and 045 in this MAP)

- Power off the system.
- Disconnect the signal cable from any installed diskette drives.
- Power on the system.
- Check the voltage at pin 28 on the signal cable (Figure 6).

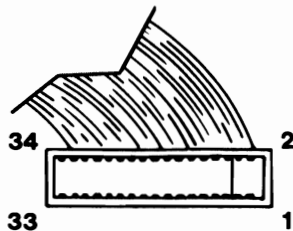

Figure 6. Signal Cable Voltage Check

(Step 060 continues)

060 (continued)

IS THE VOLTAGE BETWEEN 2.0 AND 5.5 VDC?

Yes No

061

Go to Step 130 in this MAP.

062

- Power off the system.
- Reconnect the signal cable to any installed diskette drives.
- Remove any diskettes from the diskette drives.
- Power on the system and monitor the voltage at pin 28 on the failing diskette drive circuit board during the POST (Figure 7).

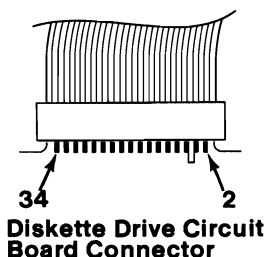

Figure 7. Voltage Check

IS THE VOLTAGE BETWEEN 2.0 AND 5.5 VDC AT THE START OF THE POST?

Yes No

063

Replace the failing diskette drive.

064

Note: "Approximately 0 Vdc" includes a range of 0 Vdc to 0.8 Vdc.

DID THE VOLTAGE DECREASE TO APPROXIMATELY 0 VDC BEFORE THE BEEP AT THE END OF THE POST?

Yes No

(Step 065 continues)

065

Go to Step 067 in this MAP.

066

Replace the failing diskette drive.

067

(From Step 065 in this MAP)

- Power off the system.
- Insert a **write-protected** diskette into the failing drive.
- Power on the system and monitor the voltage at pin 28 on the failing diskette drive circuit board during the POST. The voltage should decrease from approximately 5 Vdc at the start of the POST to approximately 0 Vdc before the beep at the end of the POST.

Note: "Approximately 5 Vdc" includes a range of 2.0 Vdc to 5.5 Vdc; "approximately 0 Vdc" includes a range of 0.0 Vdc to 0.8 Vdc.

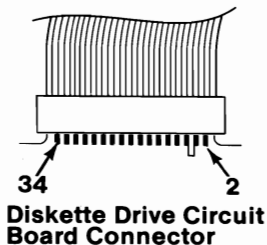

Figure 8. Voltage Check

DID THE VOLTAGE DECREASE FROM APPROXIMATELY 5 VDC TO APPROXIMATELY 0 VDC BEFORE THE BEEP AT THE END OF THE POST?

Yes No

|
|
068

Replace the failing diskette drive.

069

Go to Step 130 in this MAP.

070

(From Step 021 in this MAP)

IS DISKETTE DRIVE A FAILING?

Yes No

|

|

071

Go to Step 075 in this MAP.

072

- Check the continuity of the signal cable from pin 8 of the diskette drive A end to pin 8 of the adapter end.

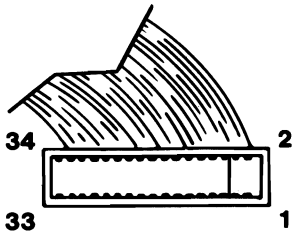

Figure 9. Signal Cable Continuity

DOES THE SIGNAL CABLE HAVE CONTINUITY?

Yes No

|

|

073

Replace the signal cable.

074

Replace the diskette drive.

075

(From Step 071 in this MAP)

- Power off the system.
- Remove diskette drive B from the system.
- Reconnect the signal and power cable connectors to diskette drive B.

(Step 075 continues)

075 (continued)

- Position diskette drive B so you can see the bottom of the drive.
- Power on the system and observe the rotor.

DID THE ROTOR SPIN BEFORE THE BEEP AT THE END OF THE POST?

Yes No

| |
 076

 Go to Step 125 in this MAP.

077

Replace diskette drive B.

078

(From Step 002 in this MAP)

ARE TWO DISKETTE DRIVES INSTALLED?

Yes No

| |
 079

 Go to Step 088 in this MAP.

080

DID THE LED ON DISKETTE DRIVE A LIGHT?

Yes No

| |
 081

 Go to Step 085 in this MAP.

082

- Power off the system.
- Disconnect the signal cable from diskette drive A.
- Power on the system and observe the LED on diskette drive B.

DID THE LED ON DISKETTE DRIVE B LIGHT BEFORE THE BEEP AT THE END OF THE POST?

Yes No

| |
 (Step 083 continues)

083

Go to Step 088 in this MAP.

084

Replace diskette drive A.

085

(From Step 081 in this MAP)

- Power off the system.
- Disconnect the signal cable from diskette drive B.
- Power on the system and observe the LED on diskette drive A.

DID THE LED ON DISKETTE DRIVE A LIGHT BEFORE THE BEEP AT THE END OF THE POST?

Yes No

086

Go to Step 088 in this MAP.

087

Replace diskette drive B.

088

(From Steps 005, 079, 083, and 086 in this MAP)

- Check the power connector at each installed diskette drive for the voltages listed in Figure 10.

Voltage (Vdc)		Pins	
Minimum	Maximum	-Lead	+Lead
+ 4.8	+ 5.2	2	4
+11.5	+12.6	3	1

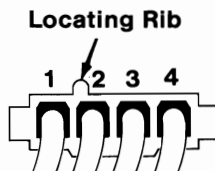

Figure 10. Diskette Drive Power Connectors

(Step 088 continues)

088 (continued)

ARE THE VOLTAGES CORRECT?

Yes No

089

Go to "MAP 0020: Power Start."

090

- Power off the system.
- Disconnect the signal cable from the diskette drives.
- Power on the system.
- Check the voltage at pin 12 on the circuit board of the failing diskette drive (Figure 11).
- The voltage should be 2.0 to 5.5 Vdc.



Figure 11. Voltage Check

IS THE VOLTAGE CORRECT?

Yes No

091

Replace the failing diskette drive.

092

- Power off the system.
- Reconnect the signal cable to the failing diskette drive.
- Power on the system and monitor the voltage at pin 12 on the circuit board of the failing diskette drive (Figure 12 on page 0600-19). The voltage should decrease from approximately 5 Vdc at the start of the POST to approximately 0 Vdc before the beep at the end of the POST.

Note: "Approximately 5 Vdc" includes a range of 2.0 to 5.5 Vdc; "approximately 0 Vdc" includes a range of 0.0 to 0.8 Vdc.

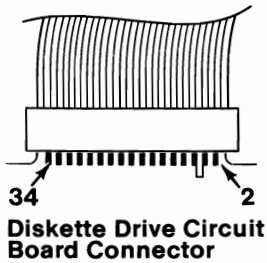

Figure 12. Voltage Check

DID THE VOLTAGE DECREASE FROM APPROXIMATELY 5 VDC TO APPROXIMATELY 0 VDC BEFORE THE BEEP AT THE END OF THE POST?

Yes No

093

Go to Step 130 in this MAP.

094

Replace the failing diskette drive.

095

(From Step 007 in this MAP)

ARE TWO DISKETTE DRIVES INSTALLED?

Yes No

096

Go to Step 100 in this MAP.

097

- Power off the system
- Disconnect the signal cable from diskette drive B.
- Power on the system.

Note: If the message (**RESUME = "F1" KEY**) appears during the POST, press **F1** to continue.

(Step 097 continues)

097 (continued)

DOES THE ADVANCED DIAGNOSTICS MENU APPEAR AT THE END OF THE POST?

Yes No

098

Go to Step 100 in this MAP.

099

Replace diskette drive B.

100

(From Steps 096 and 098 in this MAP)

- Power off the system for about 10 seconds.
- Power on the system and observe the spindle on diskette drive A (Figure 13).

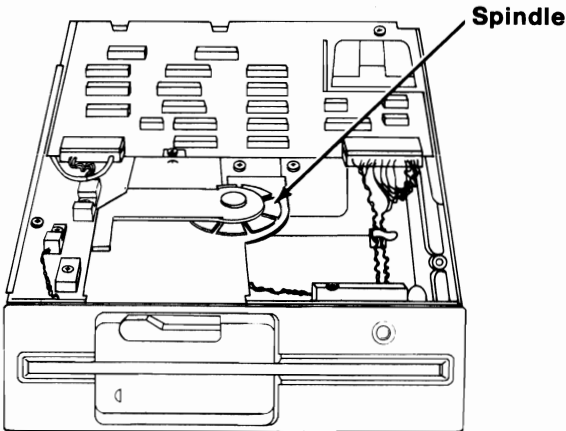

Figure 13. Diskette Drive Spindle

DID THE SPINDLE ROTATE BEFORE THE BEEP AT THE END OF THE POST?

Yes No

101

Go to Step 125 in this MAP.

102

(Step 102 continues)

102 (continued)

- Power off the system.
- Disconnect the signal cable from diskette drive A.
- Power on the system and check the voltage at pin 18 on the diskette drive A circuit board (Figure 14).



Figure 14. Voltage Check

IS THE VOLTAGE APPROXIMATELY 5 VDC?

Yes	No
	103
	Replace diskette drive A.

104

- Power off the system.
- Reconnect the signal cable to diskette drive A.
- Power on the system and monitor the voltage at pin 18 of diskette drive A (Figure 15 on page 0600-22). The voltage should decrease from approximately 5 Vdc at the start of the POST to approximately 0 Vdc before the beep at the end of the POST.

Note: "Approximately 5 Vdc" includes a range of 2.0 to 5.5 Vdc; "approximately 0 Vdc" includes a range of 0.0 to 0.8 Vdc.

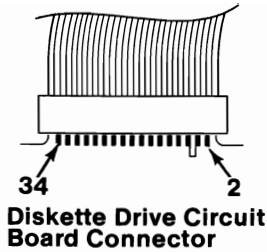

Figure 15. Voltage Check

DID THE VOLTAGE DECREASE FROM APPROXIMATELY 5 VDC TO APPROXIMATELY 0 VDC BEFORE THE BEEP AT THE END OF THE POST?

Yes No

105

Go to Step 130 in this MAP.

106

- Power off the system.
- Remove diskette drive A from the system.
- Reconnect the signal and power cable to diskette drive A.
- Manually slide the read/write head to track 0 (rear of the diskette drive). If you are unable to move the head, replace the diskette drive.
- Position diskette drive A so you can observe the read/write head from the bottom.
- Power on the system and observe the read/write head. The head should move from track 0 forward to track 39 (front of the diskette drive).

Note: Some diskette drives may perform this exercise more than one time.

DID THE HEAD MOVE AS DESCRIBED?

Yes No

107

Replace diskette drive A.

(Step 108 continues)

108

- Power off the system for about 5 seconds.
- Power on the system and monitor the voltage at pin 26 of diskette drive A (Figure 16). The voltage should decrease from approximately 5 Vdc at the start of the POST to approximately 0 Vdc before the beep at the end of the POST.

Notes:

1. "Approximately 5 Vdc" includes a range of 2.0 to 5.5 Vdc; "approximately 0 Vdc" includes a range of 0.0 to 0.8 Vdc.
2. This voltage shifts rapidly and the meter may not appear to drop all the way to 0.0 Vdc.

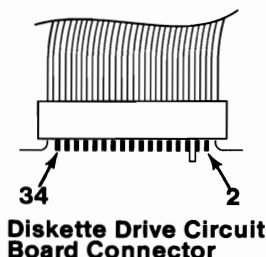

Figure 16. Voltage Check

WAS THE VOLTAGE APPROXIMATELY 5 VDC AT THE START OF THE POST?

Yes No

109

Go to Step 130 in this MAP.

110

DID THE VOLTAGE DECREASE TO APPROXIMATELY 0 VDC BEFORE THE BEEP AT THE END OF THE POST?

Yes No

111

Replace diskette drive A.

(Step 112 continues)

112

(From Step 013 in this MAP)

- Power off the system.
- Disconnect the signal cable from any installed diskette drives.
- Power on the system.
- Refer to Figure 17 and check the voltage at pin 30 of the diskette drive A signal cable connector (diskette drive end).

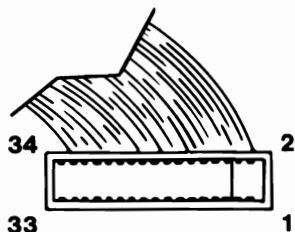

Figure 17. Signal Cable Voltage Check

IS THE VOLTAGE BETWEEN 2.0 AND 5.5 VDC?

Yes

No

113

Go to Step 130 in this MAP.

114

- Power off the system.
- Reconnect the signal cable to the diskette drives.
- Power on the system and monitor the voltage at pin 30 on each diskette drive circuit board during the POST (Figure 18 on page 0600-25).

The voltage should be approximately 5 Vdc at the start of the POST and decrease by approximately 0.5 Vdc when the diskette drive LED is on during the POST.

Note: "Approximately 5 Vdc" includes a range of 2.0 to 5.5 Vdc; "approximately 0.5 Vdc" includes a range of 0.3 to 1.0 Vdc.

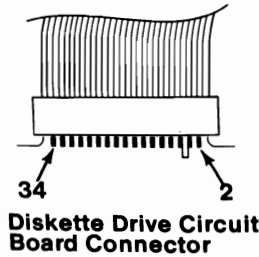

Figure 18. Voltage Check

DID THE VOLTAGE DECREASE BY APPROXIMATELY 0.5 VDC?

Yes No

|

115

Replace the failing diskette drive.

116

- Power off the system.
- Disconnect the signal cable from any installed diskette drives.
- Power on the system.
- Check for a voltage of approximately 5 Vdc at pin 32 on the diskette drive A circuit board.

Note: "Approximately 5 Vdc" includes a range of 2.0 to 5.5 Vdc.

IS THE VOLTAGE APPROXIMATELY 5 VDC?

Yes No

|

117

Replace diskette drive A.

118

(From Step 012 in this MAP)

- Power off the system.
- Disconnect the signal cable from any installed diskette drives.
- Power on the system.
- Monitor the voltage at pin 34 (diskette drive A end) of the signal cable (Figure 19 on page 0600-26).

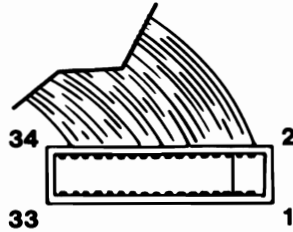

Figure 19. Signal Cable Voltage Check

IS THE VOLTAGE 5.0 VDC?

Yes

No

119

Go to Step 130 in this MAP.

120

- Power off the system.
- Reconnect the signal cable to the diskette drives.
- Power on the system and monitor the voltage of pin 34 on diskette drive A during the POST (Figure 20). The voltage should be approximately 5 Vdc at the start of the POST and drop to 0 Vdc the **first time** the LED of diskette drive A lights during the POST.

Note: "Approximately 5 Vdc" includes a range of 2.0 to 5.5 Vdc; "approximately 0 Vdc" includes a range of 0.0 to 0.8 Vdc.

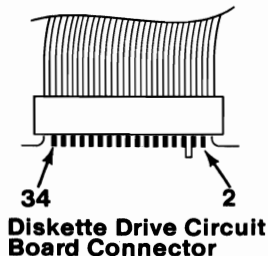

Figure 20. Voltage Check

(Step 120 continues)

120 (continued)

IS THE VOLTAGE APPROXIMATELY 5 VDC AT THE START OF THE POST?

Yes No

121

Replace the failing diskette drive.

122

DID THE VOLTAGE DROP TO APPROXIMATELY 0 VDC WHILE THE LED WAS LIT?

Yes No

123

Replace the failing diskette drive.

124

Go to Step 130 in this MAP.

125

(From Steps 076 and 101 in this MAP)

- Power off the system.
- Disconnect the signal cable from the diskette drives.
- Power on the system and check the voltage of pin 16 on the circuit board of the failing diskette drive (Figure 21). The voltage should be 2.0 to 5.5 Vdc.



Figure 21. Voltage Check

(Step 125 continues)

125 (continued)

IS THE VOLTAGE CORRECT?

Yes No

126

Replace the failing diskette drive.

127

- Power off the system.
- Reconnect the signal cable to the failing diskette drive.
- Power on the system and check the voltage at pin 16 of the failing diskette drive circuit board (Figure 22).

The voltage should decrease from approximately 5 Vdc to approximately 0 Vdc before the beep at the end of the POST.

Note: "Approximately 5 Vdc" includes a range of 2.0 to 5.5 Vdc; "approximately 0 Vdc" includes a range of 0.0 to 0.8 Vdc.

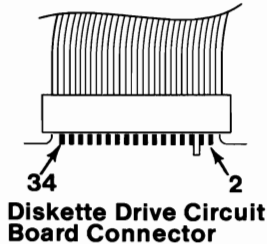

Figure 22. Voltage Check

DID THE VOLTAGE DECREASE FROM APPROXIMATELY 5 VDC TO APPROXIMATELY 0 VDC BEFORE THE BEEP AT THE END OF THE POST?

Yes No

128

Go to Step 130 in this MAP.

129

Replace the failing diskette drive.

130

(From Steps 025, 045, 052, 058, 061, 069, 093, 105, 109, 113, 119, 124, and 128 in this MAP)

- Power off the system.
- Check the diskette drive signal cable for continuity. The line numbers at one end of the cable match the line numbers at the other end, except for those listed in Figure 23. Check all lines for continuity.

Diskette Drive A Signal Cable Connector		Diskette Drive B Signal Cable Connector	
Pin Numbering		Pin Numbering	
Drive End	Adapter End	Drive End	Adapter End
10	16	10	10
11	15	11	11
12	14	12	12
14	12	14	14
15	11	15	15
16	10	16	16

Figure 23. Continuity Check

DID ALL LINES HAVE CONTINUITY?

Yes No

|

|

131

Replace the diskette drive signal cable.

132

Replace the diskette drive adapter. If this does not correct the problem, replace the system board.

Notes:

