

SIXPAKPLUS[®]

AST[®]
RESEARCH INC.

*Multifunction Expansion
Board for the IBM PC, PC
XT and Compatibles
Offering up to 576Kb of
Memory and Popular I/O
Capabilities*

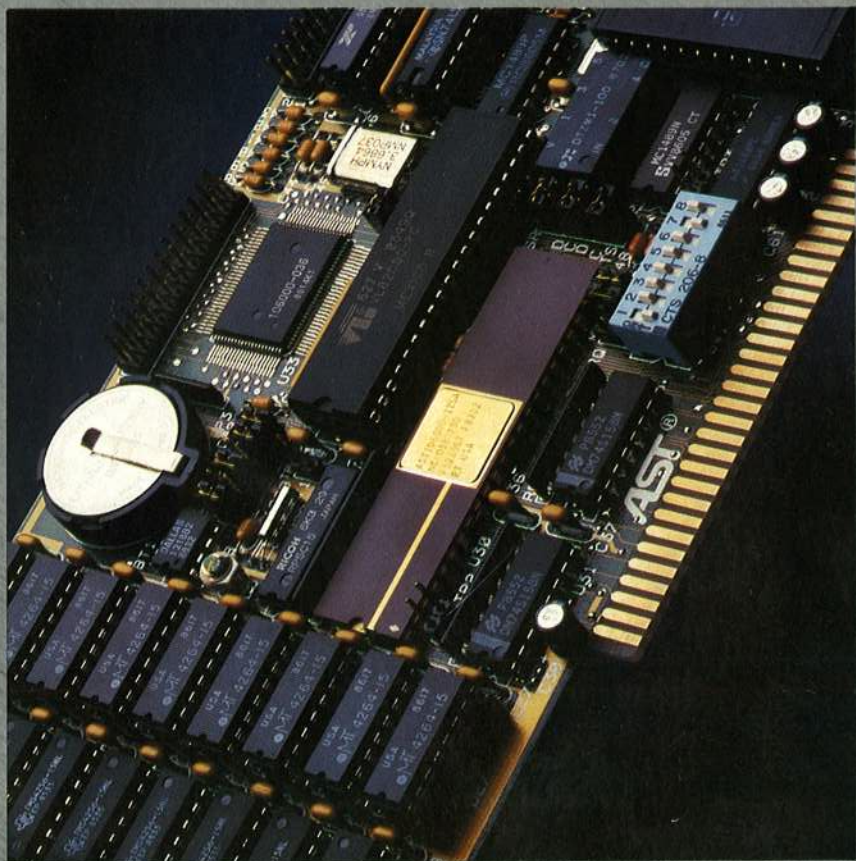

User's Manual

SixPakPlus®

Memory Expansion and I/O Card for the IBM Personal Computer, PC XT, and Other IBM-Compatible Computers

User's Manual
000490-001 A
April 1987

AST RESEARCH, INC.
Irvine, California
(714) 863-1333

First Edition (April 1987)

AST and SixPakPlus are registered trademarks of AST Research, Inc. SuperPak, SuperSpool, fASTdisk, MonoGraphPlus, Preview, and SuperDrive are trademarks of AST Research, Inc.

IBM is a registered trademark of International Business Machines Corporation. Compaq is a registered trademark of Compaq Computer Corporation. Epson is a registered trademark of Epson Corporation. Crosstalk is a registered trademark of Microstuf, Inc.

In view of demonstrated product reliability and comprehensive warranty policies, AST Research, Inc. does not normally provide schematics or material lists. AST recognizes that some customers with a large installed base of AST products want supportive documentation for their own service organizations. In such cases, customers should contact AST Research corporate offices to consider an appropriate nondisclosure agreement to obtain this documentation.

Changes are periodically made to the information contained in this manual; these changes will be incorporated into new editions.

A Product Comment Form is provided at the back of this publication. If this form has been removed, please address your comments to: AST Research, Inc., Attn: Product Marketing, 2121 Alton Ave., Irvine, CA 92714. AST Research may use or distribute any of the information you supply in any it deems appropriate without incurring any obligations whatsoever.

Copyright(c) 1987 AST Research, Inc. All rights are reserved, including those to reproduce this book or parts thereof in any form without permission in writing from AST Research, Inc.

WARNING

This manual is protected by United States Copyright law (Title 17 United States Code). Unauthorized reproduction and/or sales may result in imprisonment of up to one year and fines of up to \$10,000 (17 USC 506). Copyright infringers may be subject to civil liability.

CONTENTS

INTRODUCING SIXPAKPLUS.....	ix
Standard Features	x
Available Options.....	xi
ABOUT THIS MANUAL.....	xii
How to Find What You're Looking For	xii
Format Notation.....	xiii
Related Documentation.....	xiv
PART I. BASIC INSTALLATION	
1. BEFORE YOU BEGIN . . .	1-1
1.1 Checking the Contents.....	1-2
1.2 Compatibility and System Requirements	1-2
1.3 What You Need to Know Before You Start.....	1-3
1.3.1 Configuration Checklist.....	1-5
2. CONFIGURATION AND INSTALLATION	2-1
2.1 Factory Configuration.....	2-3
2.2 SixPakPlus Configuration.....	2-5
2.2.1 Quick Configuration for Switch SW1	2-5
2.2.2 SixPakPlus Starting Memory Address.....	2-6
2.2.3 Amount of SixPakPlus Memory	2-7

CONTENTS

2.2.4 Parity Check Enable.....	2-8
2.3 Getting Your PC Ready	2-9
2.3.1 PC System Board Switch Settings	2-11
2.3.2 PC XT, Portable PC, and 3270 PC System Board Switch Settings.....	2-14
2.3.3 Setting SW1 for the Number of Floppy Drives	2-16
2.4 Installing SixPakPlus into Your PC	2-18
2.5 Testing the New Installation	2-23
2.6 Quick Reference Configuration	2-24

PART II. ADVANCED CONFIGURATION

3. CLOCK/CALENDAR	3-1
3.1 Configuring the Clock/Calendar.....	3-1
3.1.1 Disabling the Clock/Calendar	3-2
3.2 Preparing Your PC Boot Disk.....	3-2
3.3 Setting the Time and Date.....	3-4
3.4 The Clock/Calendar Battery.....	3-7
3.5 Technical Information.....	3-9
4. MEMORY CONFIGURATION	4-1
4.1 Installing Multiple Memory Boards into Your PC.....	4-1
4.1.1 Installing a Board "Below" the SixPakPlus	4-2
4.1.2 Installing a Board "Above" the SixPakPlus	4-3

4.2 Installing Additional Memory on the SixPakPlus	4-4
4.2.1 64KB RAM Upgrade Chips	4-6
4.2.2 256 KB RAM Upgrade Chips	4-7
4.2.3 Installing RAM Chips	4-8
4.3 Troubleshooting Memory Problems	4-10
5. SERIAL PORT	5-1
5.1 Configuring the SixPakPlus Serial Port	5-1
5.1.1 Installing Multiple Serial Ports in a PC	5-2
5.1.2 Configuring the RS-232C Interface Lines	5-3
5.1.3 Disabling the Serial Port	5-6
5.2 Programming the Serial Port	5-6
5.3 Serial I/O Address Assignments and Pinouts	5-7
5.4 Serial Port Diagnostic Testing	5-8
6. PARALLEL PORT	6-1
6.1 Configuring the Parallel Port	6-1
6.1.1 Installing Multiple Parallel Ports in a PC	6-2
6.1.2 Monochrome Adapter Boards	6-2
6.1.3 Disabling the Parallel Port	6-3
6.2 Programming the Parallel Port	6-3
6.3 Parallel Port I/O Addresses and Pinouts	6-3
6.4 Parallel Port Diagnostic Testing	6-5

CONTENTS

6.5 Interrupt-Driven Parallel Printer Software	6-6
7. GAME PORT	7-1
7.1 Configuring the SixPakPlus Game Port	7-1
7.2 Software Compatibility	7-2
7.3 Game Port Technical Information	7-3
7.3.1 Game Port I/O Address Assingment	7-3
7.3.2 Game Port Pinouts	
7.4 Game Port Diagnostic Testing	7-5
7.5 Adding the Game Port to Your SixPakPlus	7-5

PART III. APPENDICES

A. TROUBLESHOOTING AND REPAIR PROCEDURE.....	A-1
A.1 Troubleshooting	A-1
A.2 Product Repair Procedure	A-4
B. SERIAL INTERFACES	B-1
B.1 RS-232C Interface Standard	B-2
B.2 Interfacing DTE to DCE	B-3
B.3 Interfacing DTE to DTE ("Null Modem")	B-6
B.4 Design Aids	B-11
C. SWITCHING BETWEEN PARALLEL PRINTER PORTS	C-1

C.1 Switching Between LPT1 and LPT2	C-2
C.2 Restoring LPT1 to LPT1 and LPT2 to LPT2.....	C-2
C.3 Switching Between LPT1 and LPT3	C-3
C.4 Restoring LPT1 to LPT1 and LPT3 to LPT3.....	C-3
D. INSTALLING SIXPAKPLUS IN THE OLDER 64-KB IBM PC	D-1

FIGURES

Figure 1-1. Installation Overview.	1-2
Figure 2-1. SixPakPlus Installation Overview.....	2-2
Figure 2-2. SixPakPlus Board Layout.....	2-4
Figure 2-3. Standard Settings for Switch SW1.....	2-6
Figure 2-4. Starting Address Settings.	2-6
Figure 2-5. SixPakPlus Memory Size Settings.....	2-7
Figure 2-6. Parity Check Enable Setting.	2-8
Figure 2-7. Removing the PC Cover.....	2-10
Figure 2-8. PC System Board Layout.....	2-12
Figure 2-9. PC System Board Switch Settings.	2-13
Figure 2-10. PC XT System Board Layout.	2-14
Figure 2-11. PC XT, Portable PC, or 3270 PC System Board Switch Settings.	2-15
Figure 2-12. System Board Switch Settings for Floppy Drives and SuperDrives.....	2-17
Figure 2-13. SixPakPlus Ribbon Cables.....	2-19
Figure 2-14. Installing the Ribbon Cable onto SixPakPlus.	2-20
Figure 2-15. Installing Your SixPakPlus Board.	2-21
Figure 2-16. Example Installation (One Ribbon Cable).....	2-22
Figure 2-17. Installing Cables.	2-23
Figure 2-18. Quick Reference Configuration.	2-25
Figure 3-1. Clock/Calendar Factory Configuration.....	3-2
Figure 3-2. Removing the SixPakPlus Clock/Calendar Battery...	3-9

CONTENTS

Figure 4-1. Memory Configuration.....	4-5
Figure 4-2. SixPakPlus Memory Banks.....	4-10
Figure 5-1. Serial Port Factory Configuration.....	5-2
Figure 5-2. Creating a "Forced True" State.....	5-5
Figure 5-3. Serial Port Loopback Plug Configuration.....	5-9
Figure 6-1. Parallel Port Factory Configuration.....	6-2
Figure 6-2. Parallel Port Loopback Plug Configuration.....	6-5
Figure 6-3. IRQ7 Enabled.....	6-6
Figure 7-1. Game Port Enable/Disable.....	7-2
Figure 7-2. Installing the Game Adapter Port ICs.....	7-7
Figure B-1. DTE-to-DCE Interface.....	B-5
Figure B-2. Example #1: Null Modem (DTE-to-DTE) Interface..	B-7
Figure B-3. Example #2: Null Modem Interface.....	B-8
Figure B-4. Example #3: Null Modem Interface.....	B-10
Figure B-5. Serial Interface Form.....	B-12
Figure D-1. Switch Setting SW2 for Total Memory in the PC.....	D-2
Figure D-2. Switch Setting SW1 for Number of Disk Drives (If Installing SuperDrive).....	D-3

TABLES

Table 3-1. Compatible Clock/Calendar Batteries.....	3-8
Table 4-1. Compatible 64-KB Memory Chips.....	4-7
Table 4-2. Compatible 256-KB Memory Chips.....	4-8
Table 5-1. I/O Addresses and IRQ Interrupt Requests.....	5-7
Table 5-2. J1 Pinouts.....	5-8
Table 6-1. Parallel Port I/O Addresses.....	6-3
Table 6-2. Parallel Port Pinouts.....	6-4
Table 7-1. SixPakPlus Game Port Pinouts.....	7-4

INTRODUCING SIXPAKPLUS

The AST SixPakPlus[®] is a flexible and powerful multifunction enhancement product for members of the IBM Personal Computer (PC) family. The SixPakPlus includes these features:

- Memory expansion from 64 kilobytes (KB) to the maximum addressable user memory in the IBM PC and PC XT systems.
- Real-time clock/calendar with battery backup.
- RS-232C asynchronous serial communications port.
- Parallel printer port.
- Optional game port.
- New compact size.

Your SixPakPlus comes with these valuable SuperPak[™] utility programs:

- *SuperDrive*[™], a disk emulation program that allows you to use part of your memory as a superfast "electronic disk drive".
- *SuperSpool*[™], an intelligent print spooler that allows you to output files to a printer while freeing your PC for other tasks.
- *RAMCLEAR*, a memory initialization program that clears your PC's random access memory (RAM) of any false parity errors.
- *ASTCLOCK*, the real-time clock-calendar program that frees you from having to reenter the time and date every time you turn on your PC.

- *fASTdisk*TM, a program that simulates fixed disks in RAM. Like SuperDrive, *fASTdisk* allows you to store and retrieve data and programs at RAM speeds.

Your SuperPak diskette may also include other software; any programs that apply to SixPakPlus are documented separately. For up-to-date information on SuperPak programs, list the README file on your SuperPak diskette (see your *SuperPak User's Manual*).

Standard Features

Standard SixPakPlus features include:

- An RS-232C serial port. You can use the serial port to interface to a modem, serial printer, remote display terminal, or other serial device. You can also use the serial port as an asynchronous communications port to another computer or peripheral operating under separate asynchronous communications software control.

NOTE

The SixPakPlus does not support a current loop teletype interface.

- A parallel printer port. You can use the parallel port to connect a parallel printer or plotter to the PC.
- A real-time clock-calendar with battery backup. Battery backup frees you from having to re-enter the time and date every time you start your system. The battery power is only used when your system is turned off.
- The SuperPak utility diskette including SuperDrive, SuperSpool, *fASTdisk*, RAMCLEAR, and ASTCLOCK.

NOTE

You must use a version 5.1 (or later) SuperPak diskette with SixPakPlus. For information on the SuperPak utilities, see your *SuperPak User's Manual*.

Available Options

These options are available for your SixPakPlus:

- Memory expansion is available in 64- or 256-KB increments up to 576 KB. This allows you to increase your PC's memory to the 640-KB maximum, no matter how much memory is on the system board. For example, the 576 KB on the SixPakPlus board added to the 64 KB on the system board gives you 640 KB.

Each 64-KB upgrade consists of one 64-KB Memory Upgrade kit (AST Model No. MP-0009). Each 256-KB upgrade consists of one 256-KB Memory Upgrade kit (AST Model No. MP-150).

- A game port (AST Model No. SPK-000G) that can be used with one or two IBM-compatible joysticks. Section 7 provides further game port information.

You can purchase these options onboard or install them at a later date. Upgrade kits are available from your dealer.

NOTES

ABOUT THIS MANUAL

This manual is designed as a user's manual. Part I, "Basic Installation" will show you how to install SixPakPlus in your PC. For most systems, this is all the information you'll need to get SixPakPlus up and running. For information on changing SixPakPlus' configuration or using its special features, refer to Part II, "Advanced Configuration". Part III, "Appendices", provides background technical information.

How to Find What You're Looking For

For Information on Compatibility and System Requirements:

Section 1 provides important considerations for installing SixPakPlus.

To Install the SixPakPlus Board:

Section 2 describes the default configuration of the SixPakPlus board and gives you instructions on installing it.

To Change a Configuration or Use SixPakPlus Features:

SixPakPlus features are described in detail in the following chapters:

Clock/calendar: Section 3.

Memory: Section 4.

Serial port: Section 5.

Parallel port: Section 6.

Game port: Section 7.

For Information on Troubleshooting and Product Repair Procedures:

Appendix A describes how to troubleshoot common problems with the SixPakPlus, and outlines the procedure for returning the SixPakPlus to the factory for repairs.

For Technical Information on the Serial Interface:

Appendix B gives general serial port wiring information.

For Information on Switching Between Parallel Printer Ports:

Appendix C provides a program that routes printer output from one parallel port to another.

For Information on Installing SixPakPlus in the Older 64-KB System Board PC:

Appendix D tells you how to configure the SixPakPlus and PC system board when installing the SixPakPlus in the original (64-KB system board) IBM PC.

Format Notation

This manual uses the following format notation:

- *Uppercase characters* indicate items that you enter exactly as shown. However, you can enter those items in any combination of upper- or lowercase letters.
- *Boldface* indicates the information that you enter, as contrasted with system prompts or messages (which are shown in regular typeface). A boldface entry can be a parameter such as a file name or a key to press.
- *Angle brackets (< >)* tell you to press a key. For example, <Esc> tells you to press the "Esc" key. You do not have to press the <Enter> key unless you are specifically told to do so.
- *Lowercase letters* identify variable information (such as filenames) that you must supply.
- *Square brackets ([])* indicate an optional term you can include or omit at your discretion. The brackets are not entered.
- System prompts and messages are shown in color.

- Hexadecimal numbers are indicated with a leading zero (0) and a trailing "h" (for example, 0207h).

Related Documentation

Your SixPakPlus comes with a SuperPak diskette (version 5.1 or later). You can find detailed information on the SuperPak utilities in the *SuperPak User's Manual*.

This manual assumes you are familiar with DOS and the IBM PC and PC XT. You can find this information in these manuals for your IBM PC:

Guide to Operations

Technical Reference

Disk Operating System

BASIC

NOTES

PART I. BASIC INSTALLATION

1. Before You Begin . . .
2. Configuration and Installation

NOTES

This section presents information you'll need before you install the SixPakPlus. Figure 1-1 shows an overview of the steps you'll take as you follow the instructions in Part I, "Basic Installation".

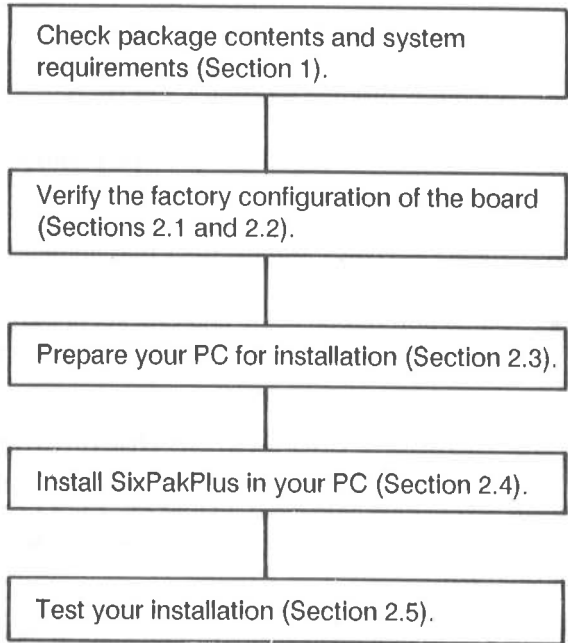

Figure 1-1. Installation Overview.

1.1 Checking the Contents

Before you get started, check that your SixPakPlus package includes the following:

- SixPakPlus circuit board.
- SixPakPlus parallel interface cable and bracket.
- SuperPak diskette (version 5.1 or later).
- *SixPakPlus User's Manual* (AST part number 000490-001).
- *SuperPak User's Manual* (AST part number 000300-001).
- Game port ribbon cable and bracket (if the game port option is included on your SixPakPlus board).

1.2 Compatibility and System Requirements

To install SixPakPlus, you need an IBM PC, PC XT or fully IBM PC-compatible computer with at least one unused full-length expansion slot.

All references to operating system commands in this manual assume operation under Disk Operating System (DOS) version 2.0 or later. SixPakPlus hardware is completely IBM-compatible and will function properly under other IBM-approved operating system software. Of course, configuring the I/O ports under another operating system requires the use of commands specific to that operating system. See your operating system manual for the appropriate command syntax.

1.3 What You Need to Know Before You Start

This section tells you what information you need before you begin installing SixPakPlus. You may have to make some modifications to the SixPakPlus board configuration depending on how your system is currently configured. A checklist appears at the end of this section. Fill out the checklist as you answer each question.

A. How much memory is on the system board?

The system board on the PC, PC XT and most compatibles can have a maximum of 256 KB. If your system board has less than 256 KB, you will need the AST Research Memory Upgrade kit to increase the memory on your SixPakPlus board.

If you have the older 64 KB PC system board, you will have to expand the SixPakPlus' memory to the full 576 KB. See Appendix D for more information.

B. Do you have another memory board in your PC?

SixPakPlus will work with other memory boards in your PC as long as they do not conflict and their total configured memory does not exceed the 640 KB maximum. See Section 4 for more details.

C. How do you plan to use the serial port?

SixPakPlus contains a serial port that allows your PC to communicate with serial devices such as modems, mice or serial printers (most printers are parallel). DOS assigns each serial port in the PC a name; the first serial port is called COM1, and the second (if present) is called COM2.

If your PC does not already have a serial port, SixPakPlus' serial port should be assigned to COM1. Because this is the default setting (the setting as configured at the factory), you do not have to do anything special to make this assignment. If your PC already has a serial port (as is the case with the PC XT),

you may want to assign the SixPakPlus' serial port to COM2 or disable it completely. See Section 5 for more information.

D. How do you plan to use the parallel port?

SixPakPlus contains a parallel port that allows your PC to communicate with parallel printers and other devices. DOS assigns each parallel port in the PC a name. The first parallel port is called LPT1, the second is LPT2 and the third is LPT3.

If your PC does not already have a parallel port, you should assign the SixPakPlus' parallel port to LPT1. Because this is the default setting (the setting as configured at the factory), you do not have to do anything special to make this assignment. If you already have a parallel port in your PC, you should configure the SixPakPlus' parallel port as LPT2 (for the second port), LPT3 (for the third port), or disable it. See Section 6 for more information.

E. Do you want to use the Clock/Calendar?

The Clock/Calendar is a battery-run device that updates the date and time while the PC is off, so you don't have to set it each time you boot the system. By default, the Clock/Calendar is enabled and ready to use with the ASTCLOCK software on the SuperPak diskette. If you already have a Clock/Calendar in your PC, you may disable the Clock/Calendar on the SixPakPlus. See Section 3 for more information.

F. Do you want to use the game port?

The game port is an optional accessory that lets you connect IBM-compatible joysticks to your PC. Game ports are available from your dealer. For more information, see Section 7.

1.3.1 Configuration Checklist

- A. How much memory is already on the system board?

- B. Do you have another memory board in your PC?
 Yes No
If yes, how much memory is on the board? _____
- C. Use the serial port as (COM1, COM2 or disabled):

- D. Use the parallel port as (LPT1, LPT2; LPT3, or disabled):

- E. Do you want to use the Clock/Calendar? Yes No
- F. Do you want to use the game port? Yes No

NOTES

CONFIGURATION AND INSTALLATION 2

This section tells you how to configure your SixPakPlus and install it in your PC. Figure 2-1 summarizes the SixPakPlus installation procedure.

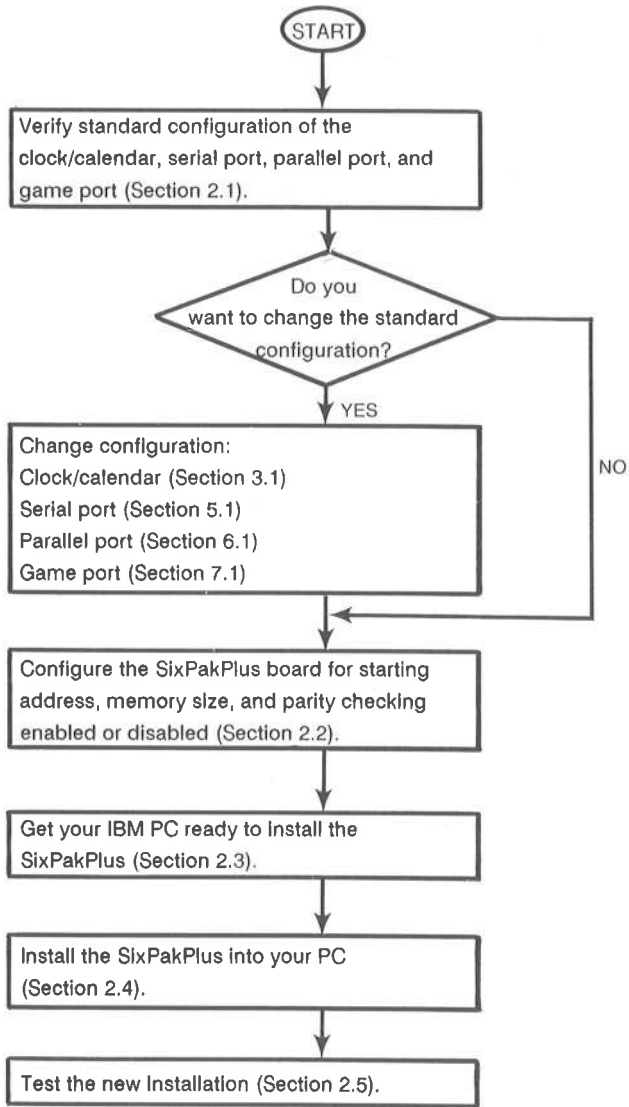

Figure 2-1. SixPakPlus Installation Overview.

Section 2.6 provides a quick reference for the switch settings on the SixPakPlus and the system board for the most common configuration.

2.1 Factory Configuration

The SixPakPlus is shipped from the factory in this configuration:

- SixPakPlus has 64 KB installed. If you purchased a SixPakPlus with 384 KB installed, you may have to change the switch settings. See Section 2.2.3.
- Clock/calendar enabled (Section 3 tells you how to change the clock/calendar configuration).
- Serial port configured as COM1, using interrupt line IRQ4 (Section 5 tells you how to change the serial port configuration or disable it if you already have a serial port installed.)
- All serial port input lines driven by the connected device (Section 5 tells you how to change the serial port configuration or disable it if you already have a serial port installed.)
- Parallel port configured as LPT1 (Section 6 tells you how to change the parallel port configuration).
- Game port enabled, if the optional game port ICs are installed (Section 7 tells you how to change the game port configuration).

To verify standard factory configuration, check that your SixPakPlus board is configured as shown in Figure 2-2.

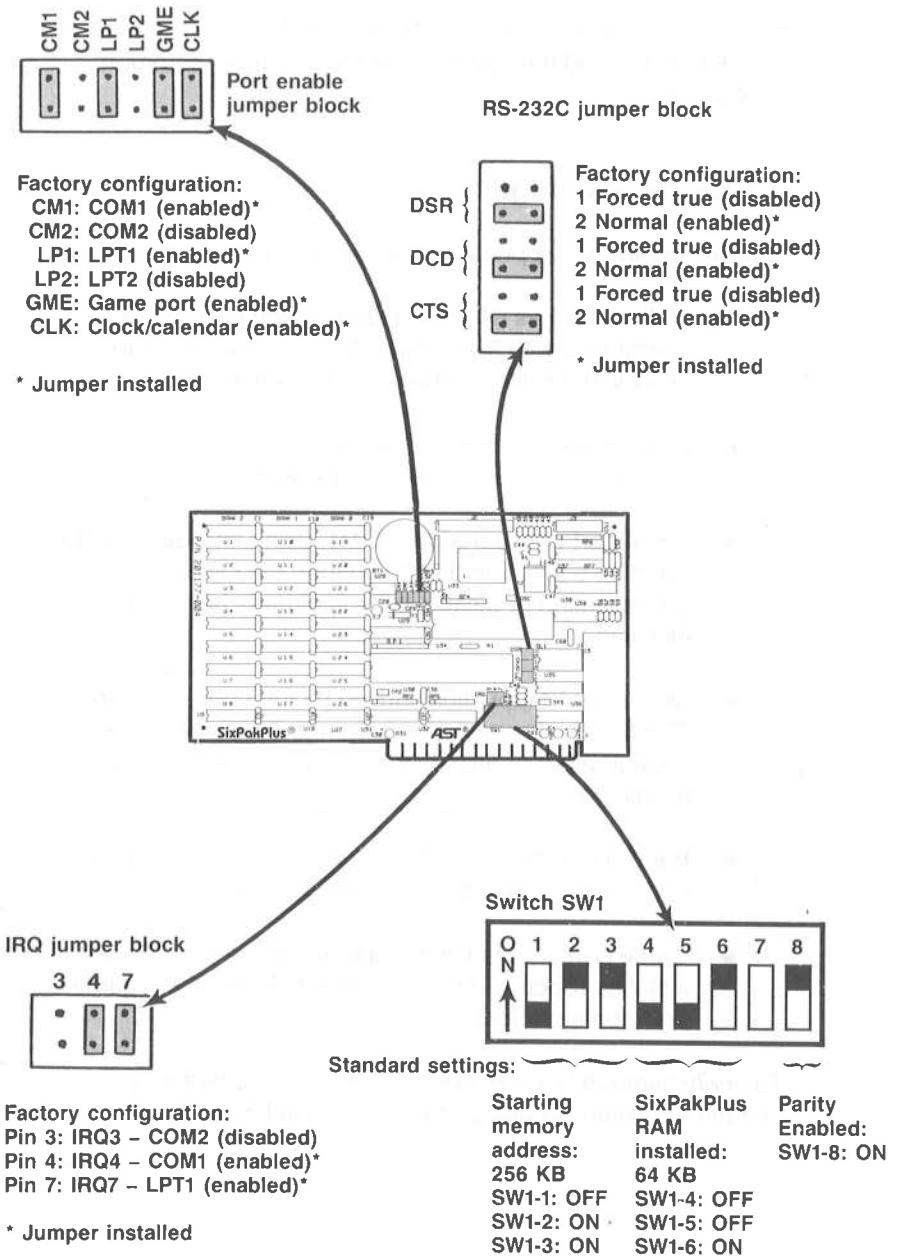

Figure 2-2. SixPakPlus Board Layout.

2.2 SixPakPlus Configuration

Switch SW1, the memory configuration switch (Figure 2-3) on the SixPakPlus, controls three different memory functions:

- The starting address of the SixPakPlus (Section 2.2.1).
- The amount of memory installed on the SixPakPlus (Section 2.2.2).
- Parity checking enabled or disabled (Section 2.2.3).

Section 4 of this manual tells you how to configure your board if you are installing multiple memory expansion boards in your PC, how to install additional memory onto your SixPakPlus, and how to troubleshoot memory problems.

2.2.1 Quick Configuration for Switch SW1

This section outlines the switch settings for SW1 that are appropriate for most users. You can use these settings if:

- The factory configuration described in Section 2.1 is satisfactory.
- Your PC currently has 256 kilobytes (KB) of memory.

If these conditions apply, skip Sections 2.2.2 through 2.2.4 and set SW1 as shown in Figure 2-3. If these conditions do not apply, follow the instructions in Sections 2.2.2 through 2.2.4.

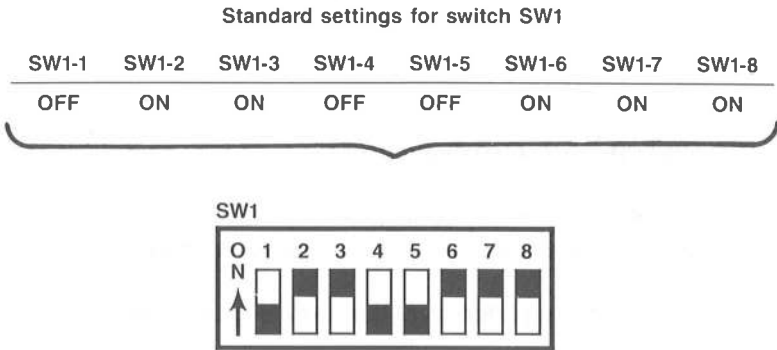

Figure 2-3. Standard Settings for Switch SW1.

2.2.2 SixPakPlus Starting Memory Address

The SixPakPlus card must be configured to indicate how much memory is installed below it -- that is, what its starting address should be. Positions 1 through 3 of SW1 set the SixPakPlus starting address as shown in Figure 2-4.

SixPakPlus Starting Memory Address

Starting address	SW1-1	SW1-2	SW1-3	Maximum RAM on SixPakPlus
64 KB (:10000)	OFF	OFF	OFF	576 KB
128 KB (:20000)	OFF	OFF	ON	512 KB
192 KB (:30000)	OFF	ON	OFF	448 KB
* 256 KB (:40000)	OFF	ON	ON	384 KB
320 KB (:50000)	ON	OFF	OFF	320 KB
384 KB (:60000)	ON	OFF	ON	256 KB
448 KB (:70000)	ON	ON	OFF	192 KB
512 KB (:80000)	ON	ON	ON	128 KB

* Factory configuration

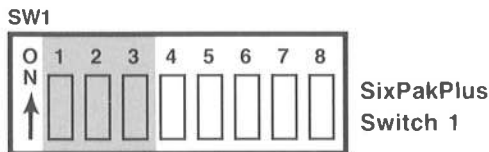

Figure 2-4. Starting Address Settings.

Set the SixPakPlus starting address to the setting in Figure 2-4 that corresponds to the amount of memory installed on the system board. For example, if your PC has 192 KB installed on its system board, set the SixPakPlus starting address to 192 KB (SW1-1 OFF, SW1-2 ON, and SW1-3 OFF).

NOTE

The SixPakPlus starting address should be above 256 KB only if another memory expansion card is installed "below" the SixPakPlus board. Section 4 tells you how to install other memory boards into your PC along with the SixPakPlus.

2.2.3 Amount of SixPakPlus Memory

You must set SW1 positions 4 through 6 to tell the SixPakPlus how much memory is installed on it (see Figure 2-5).

Number of banks installed on SixPakPlus						Total
Bank 0	Bank 1	Bank 2	SW1-4	SW1-5	SW1-6	SixPakPlus RAM
-	-	-	OFF	OFF	OFF	0 KB
64 KB	-	-	OFF	OFF	ON	64 KB*
64 KB	64 KB	-	OFF	ON	OFF	128 KB
256 KB	-	-	OFF	ON	ON	256 KB
64 KB	256 KB	-	ON	OFF	OFF	320 KB
64 KB	64 KB	256 KB	ON	OFF	ON	384 KB
256 KB	256 KB	-	ON	ON	OFF	512 KB
64 KB	256 KB	256 KB	ON	ON	ON	576 KB

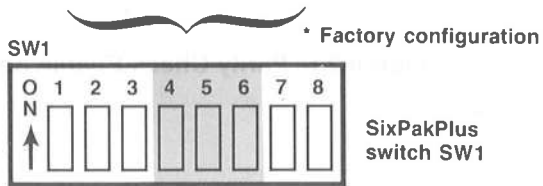

Figure 2-5. SixPakPlus Memory Size Settings.

When the starting address is 320 KB or higher, the SixPakPlus automatically limits the amount of usable memory on the card. This prevents conflicts with areas of memory reserved for the

monochrome or color display cards. This occurs even if SW1 positions 4 through 6 are configured for more memory than the maximum indicated in Figure 2-5.

NOTE

Position 7 on SixPakPlus switch SW1 is not used, and it can be ON or OFF.

2.2.4 Parity Check Enable

SW1 position 8 on your SixPakPlus (see Figure 2-6) enables or disables full parity error checking. To ensure the highest possible data integrity, you should always enable the parity check function by leaving SW1-8 ON. However, if you want to disable parity checking, set position 8 OFF.

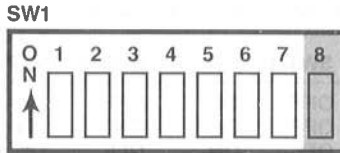

SW1-8 ON = Parity enabled
SW1-8 OFF = Parity disabled

Figure 2-6. Parity Check Enable Setting.

2.3 Getting Your PC Ready

Before you can install the SixPakPlus, you must turn off your PC, remove its cover, and verify the switch settings on the system board.

CAUTION

Be sure that the power switch is off and the power cord is removed from the system unit. Turn off any other equipment connected to the computer. Installing any component while the power is on can permanently damage your computer and its components.

You will need a flathead screwdriver or nut driver to perform the following procedure.

STEP 1

Remove cover: Remove the cover retaining screws on the rear panel of the PC and pull the PC cover off (see Figure 2-7).

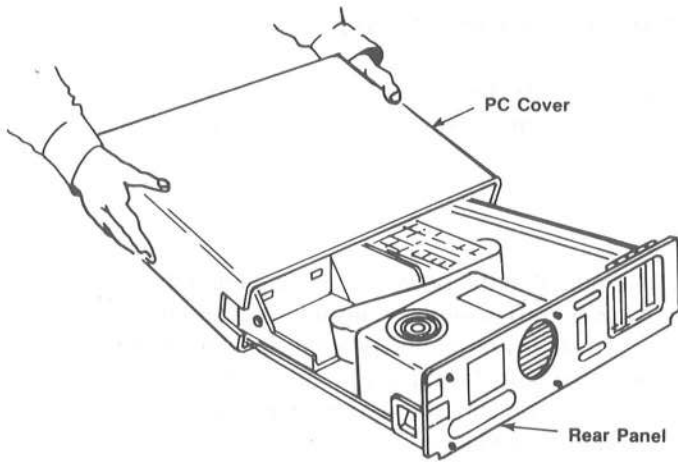

Figure 2-7. Removing the PC Cover.

STEP 2

Set the PC DIP switch:

PC: See Section 2.3.1.

PC XT, Portable PC, and 3270 PC: See Section 2.3.2.

If you are installing SuperDrive at this time: See Section 2.3.3.

You can also refer to the IBM *Guide to Operations* manual for your PC model.

NOTE

If you have an IBM Expansion Unit, you must set the Extender Card DIP switch to reflect the total amount of memory installed (system memory plus SixPakPlus memory).

2.3.1 PC System Board Switch Settings

You must tell the PC how much total memory (including any expansion memory, such as the SixPakPlus) is installed in the computer. Do this by setting the PC system board switch SW2 as described below. Figure 2-8 shows the position of SW2 on the PC system board.

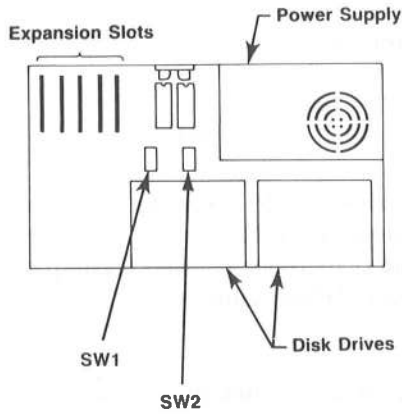

Figure 2-8. PC System Board Layout.

Add the amount of memory on the system board and the amount of memory on the SixPakPlus. Set PC system board switch SW2 to the total as shown in Figure 2-9.

Total Memory Installed

Total Memory	SW2-1	SW2-2	SW2-3	SW2-4	SW2-5
64 KB	ON	ON	ON	ON	ON
128 KB	ON	OFF	ON	ON	ON
192 KB	ON	ON	OFF	ON	ON
256 KB	ON	OFF	OFF	ON	ON
320 KB	ON	ON	ON	OFF	ON
384 KB	ON	OFF	ON	OFF	ON
448 KB	ON	ON	OFF	OFF	ON
512 KB	ON	OFF	OFF	OFF	ON
576 KB	ON	ON	ON	ON	OFF
640 KB	ON	OFF	ON	ON	OFF



SW2

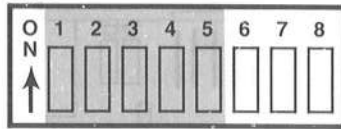

**PC System Board
Switch 2**

Figure 2-9. PC System Board Switch Settings.

2.3.2 PC XT, Portable PC, and 3270 PC System Board Switch Settings

Switch SW1 (positions SW1-3 and SW1-4) in the PC XT, Portable PC, or 3270 PC tells the computer only how much memory is installed on the system board itself. Expansion memory on the SixPakPlus will automatically be recognized. The system board used in these computers does not have to be fully populated to use expansion memory. Figure 2-10 shows the position of SW1 on the PC XT. Verify that the system board switch is properly set as shown in Figure 2-11.

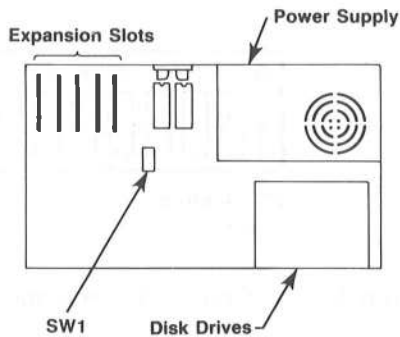
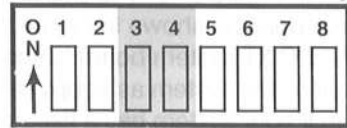

Figure 2-10. PC XT System Board Layout.

Memory On PC-XT, Portable PC, or 3270 PC System Board

System Board Memory	3	4
128 KB	OFF	ON
192 KB	ON	OFF
256 KB	OFF	OFF



**PC XT, Portable PC,
or 3270 PC System Board Switch**

Figure 2-11. PC XT, Portable PC, or 3270 PC System Board Switch Settings.

2.3.3 Setting SW1 for The Number of Floppy Drives

Your SixPakPlus comes standard with the SuperDrive disk drive simulation program. If you will be using SuperDrive, you must set the system board switch SW1 (positions SW1-1, SW1-7, and SW1-8) at this time for the number of floppy drives in your PC, as shown in Figure 2-12. The position of switch SW1 on the PC system board is shown in Figure 2-8. The position of switch SW1 on the PC XT system board is shown in Figure 2-10. SuperDrives appear to the system as floppy drives, so include them in your count; if your system has a fixed (hard) disk, do not include it in the count.

For further information on the SuperDrive program (or any of the other SuperPak programs), see your *SuperPak User's Manual*.

Configuration and Installation

Number of floppy drives and SuperDrives	System Board Switch #1	Floppy/SuperDrive Designations	IBM Fixed Disk Designation
1		A:	C:
2		A:B:	C:
3		A:B:C:	D:
4		A:B:C:D:	E:

Figure 2-12. System Board Switch Settings for Floppy Drives and SuperDrives.

2.4 Installing SixPakPlus into Your PC

You can install the SixPakPlus card in any unused full-length expansion slot on the system board.

CAUTION

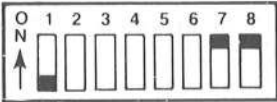
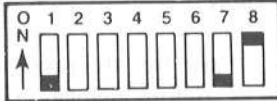
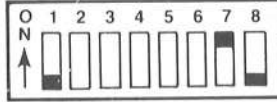
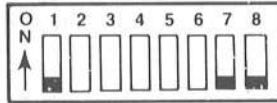
Be sure that the power is off and that the power cord is removed from the PC before installing or removing any equipment.

STEP 1

This step is required only if you plan to use the game or parallel printer ports mounted on the supplied brackets. If not, go directly to STEP 2.

Install the ribbon cable(s): Find the ribbon cable(s) for the parallel port and/or the game port (shown in Figure 2-13). The parallel port ribbon cable is about 1-1/4 inches wide, with a rectangular connector at one end and a DB25S connector at the other end. The game port ribbon cable is about 3/4 inches wide, with a rectangular connector at one end and a DB15S connector at the other end.

Each ribbon cable comes with a bracket. Use the hardware supplied with each D-shell connector to mount the connector on its bracket. *Parallel port:* Plug the rectangular connector onto connector J2. *Game port:* Plug the rectangular connector onto connector J3. (Figure 2-2 shows the locations of connectors J2 and J3.)

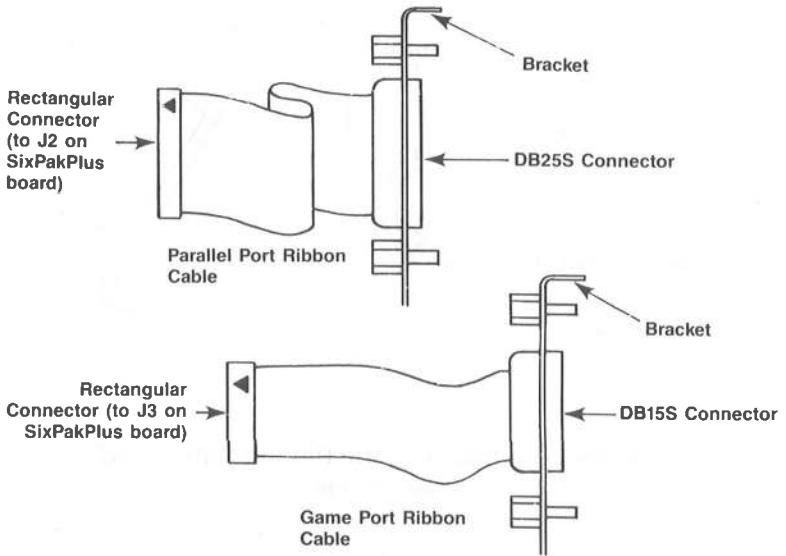

Figure 2-13. SixPakPlus Ribbon Cables.

Plug the connector onto the board so that pin 1 on the rectangular connector (indicated by a triangle and the stripe on the ribbon cable) is closest to pin 1 on the J2 or J3 connector (indicated by the "1" silkscreened in white on the board), as shown in Figure 2-14.

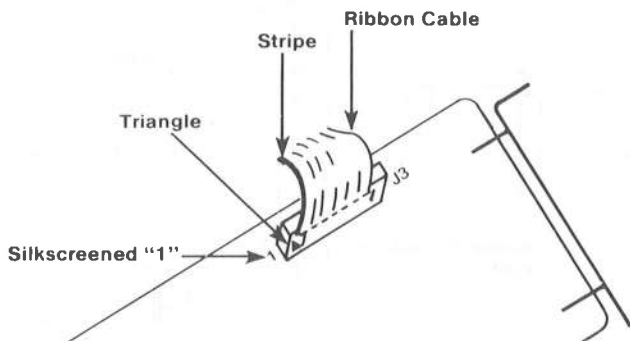

Figure 2-14. Installing the Ribbon Cable onto SixPakPlus.

STEP 2

Select an open expansion slot: The SixPakPlus board requires one full-length slot. You will need an additional slot (not necessarily full-size) if you use the parallel port bracket or the game port bracket.

STEP 3

Remove brackets: Locate the metal bracket that covers the cutout in the back panel of the PC chassis for the slot that you

have selected. Remove and save the bracket retaining screw using a small flathead screwdriver. Remove the bracket.

STEP 4

Install the SixPakPlus board: Lower the card until its edge connector is resting on the expansion slot receptacle. Using an evenly distributed pressure, press the SixPakPlus straight down until it seats in the expansion slot (Figure 2-15).

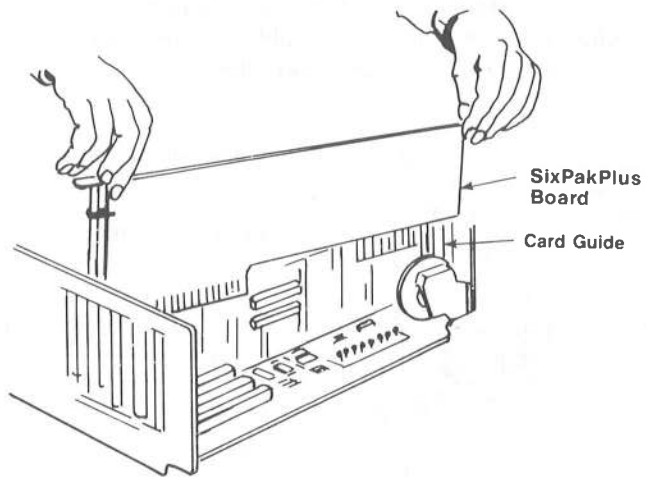

Figure 2-15. Installing Your SixPakPlus Board.

STEP 5

Install parallel port and/or game port: Install the bracket(s) with the D-shell connector(s) into the cutout(s) you have chosen. Figure 2-16 illustrates an example installation, including one ribbon cable.

NOTE

To avoid wear on the ribbon cable when you remove and replace the PC cover, route the parallel port and game port cables under other boards in the PC whenever possible.

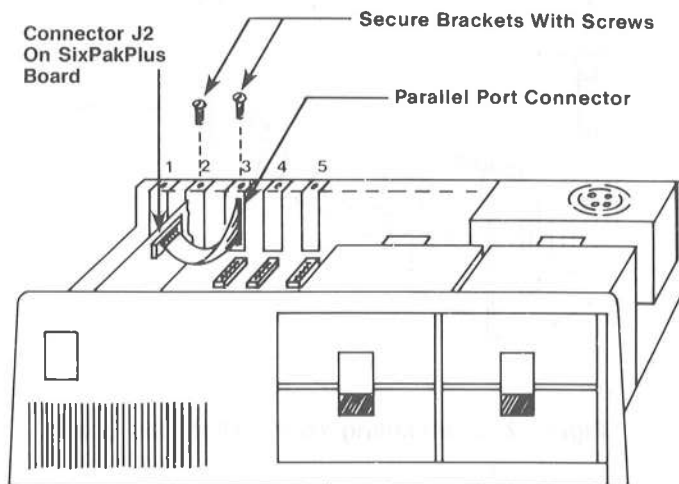

NOTE: This is an example only: you can install the SixPakPlus and its parallel port into any open slots in the PC. (SixPakPlus board requires full-size slot)

Figure 2-16. Example Installation (One Ribbon Cable).

STEP 6

Reinstall the bracket retaining screw(s): Secure the bracket(s) to the rear of the PC chassis.

STEP 7

Replace PC cover: You can replace the system unit cover now, or you can wait until you've checked the new installation (Section 2.5).

STEP 8

Install cables: Replace the power cord to the system unit and be sure that the keyboard and the monitor connectors are plugged in (Figure 2-17).

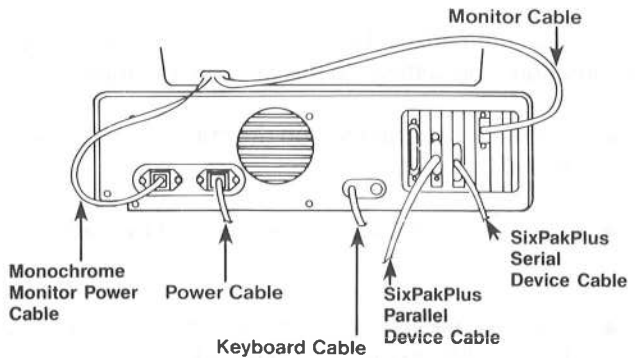

Figure 2-17. Installing Cables.

2.5 Testing the New Installation

Test your new installation with the following procedure.

STEP 1

With the power off, insert an IBM Disk Operating System (DOS) diskette in drive A, and turn on the power. If the installation was done correctly, the system will boot normally. Because there is now more memory installed in your PC, the PC will take longer to boot up than before.

STEP 2

Run the IBM diagnostic routines to check out the features you have just installed. See your IBM *Guide to Operations* manual for instructions. The diagnostic routines do not test the clock/calendar feature.

STEP 3

Use the clock/calendar software (included on your SuperPak diskette) to set the correct time and date on your SixPakPlus. Section 3 tells you how to set your SixPakPlus clock/calendar.

2.6 Quick Reference Configuration

Figure 2-18 summarizes the switch settings for the most common configuration. The settings in this section are appropriate if:

- The factory configuration described in Section 2.1 is installed.
- The PC has 256 KB of memory, and the SixPakPlus has 64 KB.
- The SixPakPlus is installed in a PC (not a PC XT) which has 256 KB on the system board.
- The PC has two floppy drives and one SuperDrive (the presence or number of hard drives is irrelevant).

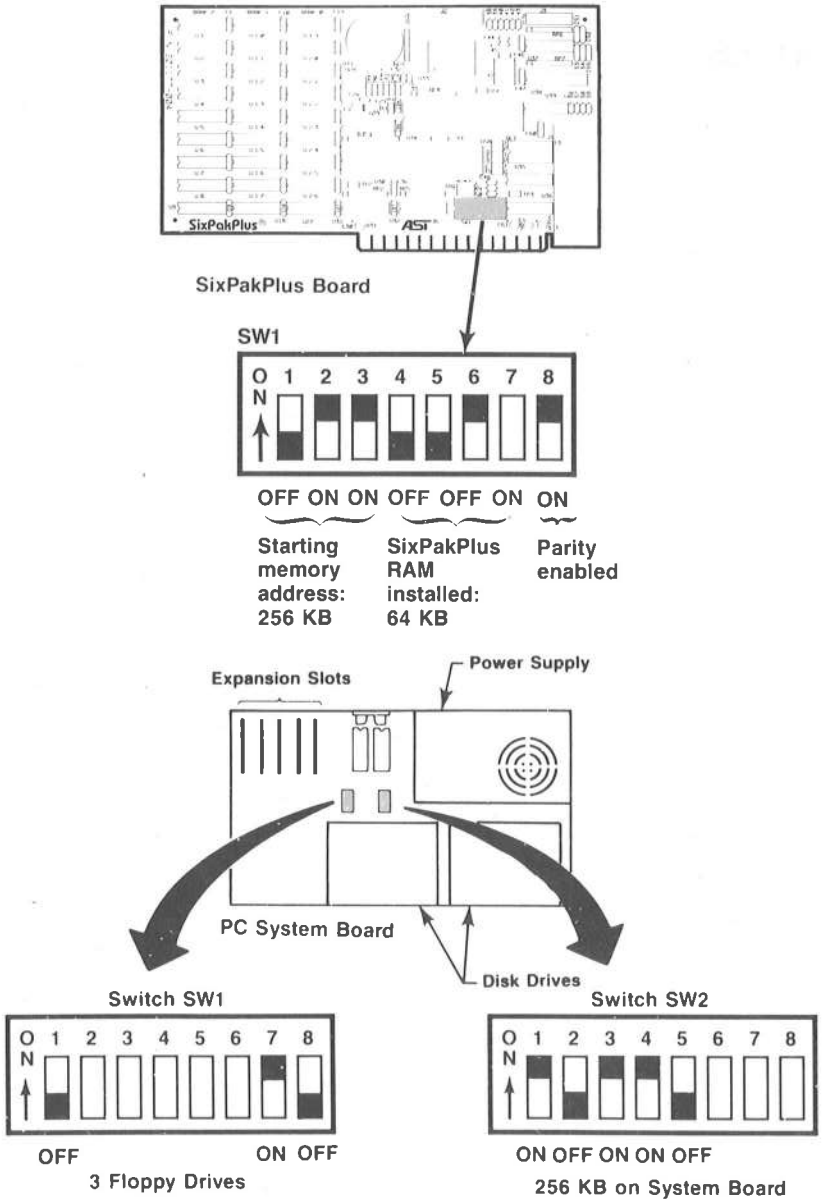

Figure 2-18. Quick Reference Configuration.

NOTES



PART II. ADVANCED CONFIGURATION

3. Clock/Calendar
4. Memory Configuration
5. Serial Port
6. Parallel Port
7. Game Port

NOTES

The SixPakPlus Clock/Calendar can answer the TIME and DATE prompts that the Disk Operating System (DOS) issues each time you boot the system. The PC is not aware of the existence of any expansion card clock unless you use the clock software supplied on your SuperPak diskette.

NOTE

You must use a version 5.1 (or later) SuperPak diskette with your SixPakPlus.

The standard SixPakPlus Clock/Calendar features include:

- 24-hour clock, maintained in an advanced microprocessor chip on the SixPakPlus board.
- Battery backup power supply (with a battery life of approximately one year).
- Replaceable lithium battery.
- Full PC-DOS compatibility.
- Automatic accounting for leap year.

3.1 Configuring the Clock/Calendar

SixPakPlus is shipped from the factory with the clock/calendar enabled. To confirm the default configuration, check that a shorting plug is installed at position CLK of the Port Enable Jumper Block, as shown in Figure 3-1.

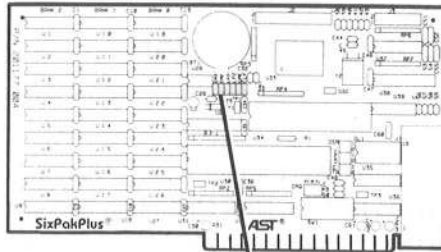

Pin CLK-clock/calendar enable
(Install shorting plug to enable clock/calendar.
Remove shorting plug to disable clock/calendar.)

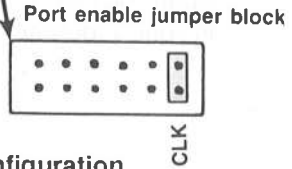

Figure 3-1. Clock/Calendar Factory Configuration.

3.1.1 Disabling the Clock/Calendar

You can disable the Clock/Calendar by removing the shorting plug from position CLK as shown in Figure 3-1. You might want to disable the Clock/Calendar to avoid a conflict between the I/O addresses used by the SixPakPlus clock and other devices installed in your PC. The SixPakPlus Clock/Calendar uses I/O addresses 02C0h through 02C7h.

Section 3.5 provides further technical information on the SixPakPlus Clock/Calendar.

3.2 Preparing Your PC Boot Disk

Once you've installed your SixPakPlus card, you can prepare your PC boot disk to automatically initialize the time and date each time that you boot the system. This subsection tells you how to prepare your DOS disk to automatically invoke the Clock/Calendar.

STEP 1

If you have not already done so, copy the **ASTCLOCK.COM** program from a SuperPak diskette (version 5.1 or later) to your PC boot disk.

If you are unsure how to **COPY** a file, consult your *DOS Manual*.

STEP 2

If your working DOS diskette already has an **AUTOEXEC.BAT** file, you must alter that file to include the **ASTCLOCK** command. To see the current contents of your **AUTOEXEC** file, enter this command (with **AUTOEXEC.BAT** in the default drive):

TYPE AUTOEXEC.BAT <Enter>

Your screen will display the contents of your **AUTOEXEC** file. Now you must create a new **AUTOEXEC** file in which the command **ASTCLOCK** precedes these other command(s). Enter this command sequence:

COPY CON: AUTOEXEC.BAT <Enter>

ASTCLOCK <Enter>

.
.
(other commands)

.
<Function key F6> <Enter> or <Ctrl-Z> <Enter>

If your working DOS disk has no **AUTOEXEC** file, use the sequence above to create one (the only command in the file will be **ASTCLOCK**).

For more information about **AUTOEXEC** files or the **DOS COPY** command, see your *DOS Manual*.

NOTE

If you want ASTCLOCK to display the date in European format (dd/mm/yy) when you boot the system, substitute the command ASTCLOCK/E for ASTCLOCK in your AUTOEXEC file.

Specifying the E parameter in the AUTOEXEC file only changes how ASTCLOCK shows the date when you boot the system; it does not affect how DOS or other software displays the date.

STEP 3

Reboot your PC (press the <Ctrl>-<Alt>- key sequence).

The ASTCLOCK command will display the time and date on the screen. If necessary, use the ASTCLOCK /R parameter to set the TIME and DATE on the SixPakPlus as detailed in Section 3.3.

3.3 Setting the Time and Date

This section tells you how to set the time and date in the SixPakPlus clock chip.

NOTE

You must use a version 5.1 (or later) SuperPak diskette to set the SixPakPlus clock chip.

Once you have copied ASTCLOCK to your PC boot disk, you can update the Clock/Calendar on the SixPakPlus internal microprocessor chip. DOS TIME and DATE commands only update the system's time and date parameters in memory; they don't permanently update the values stored in the SixPakPlus clock chip until you execute this procedure:

STEP 1

Boot the system with a disk that contains the ASTCLOCK.COM program.

STEP 2

Enter this command:

ASTCLOCK /R <Enter>

Your PC will then display a message like this (the actual date and time will be different):

```
A S T c l o c k   Version x.xx  
(c) Copyright AST Research, Inc.,  
      1982, 1984, 1985.
```

```
resident clock/calendar  
DATE & TIME processors loaded.
```

```
Current date is 05/21/87  
Current time is 08:07:56.65
```

NOTE

If you want ASTCLOCK to display the date in European format (dd/mm/yy) when you enter this command, type **ASTCLOCK/R/E** instead of **ASTCLOCK/R**. Specifying the /E parameter only changes how ASTCLOCK shows the date when you enter this command; it does not affect how DOS or other software displays the date.

STEP 3

Enter this DOS command:

DATE <Enter>

Your PC will display the current date (the actual date displayed may be different):

```
Current date is Thurs 5-21-1987  
Enter new date:
```

Enter the new month, day, and year as follows:

mm-dd-yy <Enter>

where *mm* is the one or two-digit month designation, *dd* is the day, and *yy* is the year.

If you do not want to change the date, press **<Enter>** only.

STEP 4

Enter this DOS command:

TIME <Enter>

Your PC will then display the current time (the actual time displayed may be different):

Current time is 8:14:15.82
Enter new time:

Enter the new hour, minute, and second as follows:

hh:mm:ss <Enter>

where *hh* is the hour, *mm* is the minute, and *ss* is the second. Be sure to use 24-hour format for the hour (that is, 1:00 PM = 13:00, 2:00 PM = 14:00, and so on).

Do not enter hundredths of a second. If you do not want to change the time, press **<Enter>** only.

Hint: For maximum accuracy, type in a time that is 10 to 15 seconds ahead of the actual time, then observe a digital watch, and press **<Enter>** when the seconds reading on the watch catches up to the value that you typed in.

STEP 5

Reboot your computer by pressing the **<Ctrl>-<Alt>-** key sequence.

NOTE

Selecting the ASTCLOCK /R parameter selects the resident option, which allows you to update the date and time in both PC memory and the SixPakPlus clock chip (you cannot update the clock chip unless a certain portion of the ASTCLOCK.COM program is resident).

If you use the ASTCLOCK command without the /R parameter, it simply initializes the PC's date and time by reading that information from the SixPakPlus clock chip, and then "goes away"; no portion of ASTCLOCK remains resident, so you cannot update the date and time information in the clock chip.

3.4 The Clock/Calendar Battery

The lithium Clock/Calendar battery should last for about a year, and is easily replaceable. You can purchase replacement batteries from your AST product dealer (part 108-BR2325). Compatible substitution batteries can also be purchased from local camera or department stores. Table 3-1 lists compatible lithium batteries.

Table 3-1. Compatible Clock/Calendar Batteries.

Manufacturer	Part Number
AST	108-BR2325
Duracell	DL2032
General Electric	BR2325
Panasonic	BR2325
Ray-O-Vac	BR2325
Sanyo	CR2032
Varta	CR2032
Radio Shack	CR2320H*

*Compared to the other batteries listed in this table, the Radio Shack battery is .5 mm thinner and rated at 50 mAh less than the other batteries listed. Its life expectancy is approximately 9 months (compared to a year for the other batteries).

Because the battery is used only when your PC is not operating, the actual life of your battery will be determined by how much the PC is used. The clock chip on your SixPakPlus is powered by the PC system when your PC is on. The battery is used as backup power only while your PC is off.

To replace the battery, slightly lift the retaining clip with your finger (or a small screwdriver) and use your thumb or another small screwdriver to slide the silver battery sideways out of the battery socket (Figure 3-2). Do not remove the battery socket from the board.

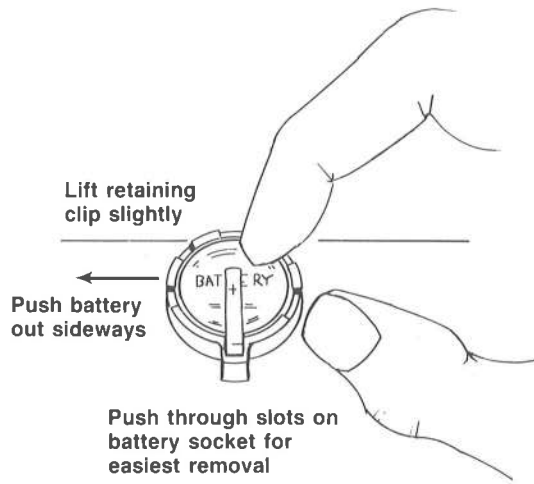

Figure 3-2. Removing the SixPakPlus Clock/Calendar Battery.

Take care not to damage or bend the retaining clip by lifting it too far. The clip completes an electrical circuit and must make solid contact with the positive (+) side of the battery. Whenever the battery is removed, it is a good idea to check the clip in the bottom of the battery holder. Be sure that it is sticking up high enough to make good contact with the bottom surface of the battery. When installing a new battery, make sure it is clean and dry.

NOTE

If you replace the battery, be sure to use the procedure described in Section 3.3 to restore the proper time and date.

3.5 Technical Information

The SixPakPlus Clock/Calendar chip is the RICOH RP5C15, and uses I/O locations 02C0h through 02C7h. For more information, consult the programming information in the *RICOH RP5C01/RP5C15 Application Manual*. AST Research cannot provide any information other than what is presented here.

NOTES

This section tells you how to:

- Install other memory expansion boards in your PC along with the SixPakPlus (Section 4.1).
- Install additional memory on your SixPakPlus board (Section 4.2).
- Troubleshoot memory problems (Section 4.3).

Section 2 of this manual tells you how to configure your SixPakPlus board (for starting address, memory size, and parity error checking enable/disable) before you install it into your PC.

4.1 Installing Multiple Memory Boards into Your PC

The advanced design of the AST Research SixPakPlus makes it compatible with most other expansion boards available for the IBM PC. However, when more than one memory expansion board is installed, you must configure the boards to prevent conflicts between them.

When you install multiple memory boards, you must first determine where each board is to reside in the PC's memory area. You can usually install your SixPakPlus either "above" or "below" the address space occupied by another board:

- Section 4.1.1 tells you how to install another memory board "below" the SixPakPlus.
- Section 4.1.2 tells you how to install another memory board "above" the SixPakPlus.

4.1.1 Installing a Board "Below" the SixPakPlus

To address another memory board "below" the SixPakPlus, follow this procedure:

STEP 1

Configure other board to reside immediately "above" the PC system board memory: Follow the configuration instructions supplied with the other board.

STEP 2

Disable any unused memory sockets on the other board: If there are any unused rows of memory sockets on the other board, disable them so they won't conflict with the SixPakPlus. Refer to the other board's manual for information on how to disable unused sockets. If you cannot disable unused memory sockets, you should address the other board "above" the SixPakPlus (as described in Section 4.1.2). If the other board has switch settings for the amount of memory on it, then it will probably automatically disable any unused memory sockets.

STEP 3

Set the SixPakPlus starting address and memory size: Add the amount of memory on the other board to the amount of memory on the PC's system board, and set the SixPakPlus starting address at this value as shown in Figure 2-2 (Section 2 of this manual). Set the SixPakPlus memory size as shown in Figure 2-3.

STEP 4

PC: *Set the PC system board switches for the total amount of memory in your PC:* The total amount of memory includes the system board, the SixPakPlus, and the other memory expansion board.

PC XT, Portable, and 3270 PC: *Check that the PC system board switches are set for the memory installed on the system board only (do not include the memory on the SixPakPlus or any other expansion memory board).* Unless you have changed the amount of system board memory, these switch settings should not change.

NOTE

If you have an IBM Expansion Unit, you must set the Extender Card switch to reflect the total amount of memory installed (system memory plus expansion board memory).

4.1.2 Installing a Board "Above" the SixPakPlus

To address another memory board "above" the SixPakPlus, follow these steps:

STEP 1

Set the SixPakPlus starting address and memory size: The SixPakPlus starting address corresponds to the amount of memory on the PC system board. Set the memory size for the amount of memory on the SixPakPlus itself (see Figures 2-2 and 2-3).

STEP 2

Set the other board's starting address and memory size: Add the total memory installed on your PC system board to the amount of SixPakPlus memory. Follow the instructions supplied with the other memory board to set its starting address for this total. If necessary, also configure the other board for the amount of memory installed on it.

STEP 3

PC: *Set the PC system board switches for the total amount of memory in your PC:* The total amount of memory includes the system board, the SixPakPlus, and the other memory expansion board.

PC XT, Portable PC, and 3270 PC: *Check that the PC system board switches are set for the memory installed on the system board only (do not include the memory on the SixPakPlus or any other expansion memory board).* Unless you have changed the amount of system memory, these settings should not change.

NOTE

If you have an IBM Expansion Unit, you must set the Extender Card switch to reflect the total amount of memory installed (system memory plus expansion board memory).

4.2 Installing Additional Memory on the SixPakPlus

It is easy to add memory to your SixPakPlus any time; you can upgrade the SixPakPlus to a maximum 576 kilobytes (KB) of random access memory (RAM). You may add 64- or 256-KB RAM chip sets, or a combination of both, to configure the SixPakPlus board to the amount of memory you need.

Figure 4-1 shows which RAM chip sets and switch settings are required to configure your SixPakPlus board to the amount of memory you want.

Number of banks installed on SixPakPlus						Total
Bank 0	Bank 1	Bank 2	SW1-4	SW1-5	SW1-6	SixPakPlus RAM
-	-	-	OFF	OFF	OFF	0 KB
64 KB	-	-	OFF	OFF	ON	64 KB*
64 KB	64 KB	-	OFF	ON	OFF	128 KB
256 KB	-	-	OFF	ON	ON	256 KB
64 KB	256 KB	-	ON	OFF	OFF	320 KB
64 KB	64 KB	256 KB	ON	OFF	ON	384 KB
256 KB	256 KB	-	ON	ON	OFF	512 KB
64 KB	256 KB	256 KB	ON	ON	ON	576 KB

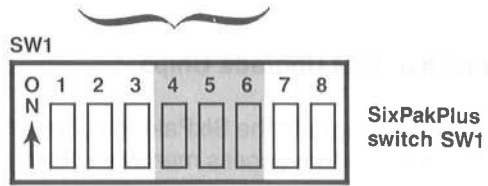

* Factory configuration

Figure 4-1. Memory Configuration.

RAM upgrade kits are available from AST in either 64 KB (Model No. MP-0009) or 256 KB (Model No. MP-150) sets. If you want to upgrade the SixPakPlus with your own chips, see the specifications in Section 4.2.1 for 64 KB RAM chips or Section 4.2.2 for 256 KB.

NOTE

You must use chips that meet the specifications listed in Sections 4.2.1 and 4.2.2. If you install chips that do not meet these specifications, your computer may malfunction.

If you wish to use the AST memory upgrade kits, you may skip to Section 4.2.3 for installation instructions.

4.2.1 64-KB RAM Upgrade Chips

If you want to upgrade the SixPakPlus yourself with 64 KB chips, use dynamic random access memory (DRAM) chips with these characteristics:

- 150 or 200 nanosecond (ns) access time
- Pin 1 not used
- +5 Volt only

The memory chips listed in Table 4-1 are compatible with the SixPakPlus and the PC or PC XT system board.

Table 4-1. Compatible 64-KB Memory Chips.

Manufacturer	Part Number
AMD	AM9064-15PC, AM9064-20PC
Fujitsu	MB8264-15P, MB8264-20P
Hitachi	HM4864P-2
Inmos	IMS2600P-15
Intel	P2164A-15, P2164A-20
Micron Technology	MT4264N-2, MT4264N-15, MT4264N-3, MT4264N-20
Mitsubishi	M5K4164ANP-15, M5K4164ANP-20
Mostek	MK4564N-15, MK4564N-20
Motorola	MCM4164BP15, MCM6665AP15, MCM6665BP15, MCM6665AP20, MCM6665BP20
NEC	UPD4164C-2, UPD4164C-3
OKI	MSM3764-15RS, MSM3764-20RS
Texas Instruments	TMS4164-15NL, TMS4164-20NL
Toshiba	TMM4164P-3, TMM4164P-4, TMM4164AP-15, TMM4164AP-20

4.2.2 256 KB RAM Upgrade Chips

If you want to upgrade the SixPakPlus yourself with 256 KB chips, use dynamic random access memory (DRAM) chips with these characteristics:

- 100, 120 or 150 nanosecond (ns) access time
- Pin 1 not used
- + 5 Volt only

The memory chips listed in Table 4-2 are compatible with the SixPakPlus.

Table 4-2. Compatible 256 KB Memory Chips.

Manufacturer	Part Number
AT&T	WCM41256FX-15
Fujitsu	MB81256-15
Hitachi	HM50256P-15
Mitsubishi	M5M4256P
Motorola	MCM6256L
NEC	D41256C-15
Texas Instruments	TMS4256-15NL
Toshiba	TMM41256P-15

4.2.3 Installing RAM Chips

Follow this procedure when you add memory to the SixPakPlus:

STEP 1

Shut off the power to the PC and remove the SixPakPlus board from the PC.

STEP 2

Install each additional set of nine 64- or 256-KB memory chips in the next empty bank on the board. For example (refer to Figure 4-1) if your SixPakPlus has 64 KB on it now, it has memory in Bank 0 only. If you want add 320 KB to SixPakPlus to bring the memory up to 384 KB, you will install one set of 64-KB chips in Bank 1 and one set of 256 KB chips in Bank 2.

Install the new chips carefully, and take care not to bend the legs. Install the new chips so that the notched ends face the same direction as the other memory chips installed on the board (see Figure 4-2). If the memory chip is not notched, install it so that the pin 1 indicator (a dot in one corner of the chip) faces toward the lower left corner of the board.

NOTE

Each bank of nine chips must be populated entirely. Do not intermix 64 KB and 256 KB chips in the same bank.

STEP 3

Set SixPakPlus DIP switch SW1 for the new total amount of memory on the board. Figure 4-1 shows you how to set SW1 for the SixPakPlus memory size.

STEP 4

PC only: Set DIP switch SW2 on the PC system board to the new total amount of memory installed in the PC (see Figure 2-8). This step is unnecessary for the PC XT, Portable PC, or 3270 PC.

STEP 5

Reinstall the SixPakPlus into the PC and power it up. Now that there is more memory in the PC, the powerup diagnostics will take longer to run. If all goes well, the system should operate normally and show the correct new total amount of memory when you enter the DOS CHKDSK command.

You can also run the IBM diagnostic routines (see your IBM PC *Guide to Operations* manual).

If you get an error, recheck the installation of the new chips and the switch settings on both the system board and the SixPakPlus. If everything appears to be correctly installed and configured, and you still get an error, then proceed to Section 4.3 for help in troubleshooting the problem.

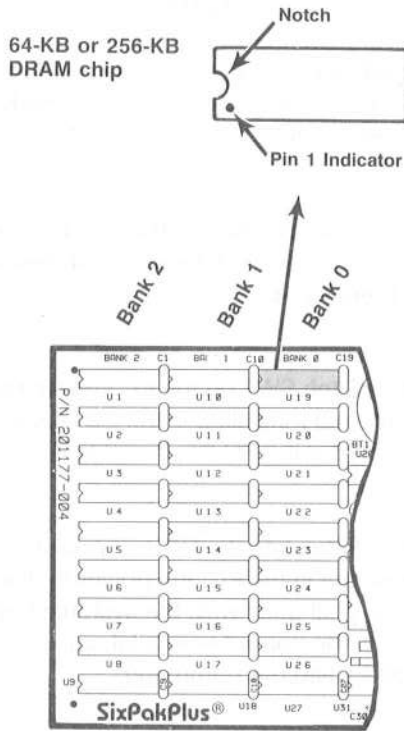

Figure 4-2. SixPakPlus Memory Banks.

4.3 Troubleshooting Memory Problems

The most common indication of a memory problem in the PC is a PARITY CHECK 2 message on powerup. These examples illustrate the format of error messages you might see.

If you have a PC, an error message might look like this:

4020 201

If you have a PC XT, Portable PC, or 3270 PC, an error message might look like any of these:

40000 20 201

40000 (S)

40000 (S) 201

????? (S) 201

Sometimes you can use the error code to isolate the problem to a specific memory chip.

The first digit of the error message indicates in which 64-KB bank the error is occurring. The message 4020 or 40000 tells us that the error is occurring in Bank 4 of the PC. Because the computer numbers its memory banks beginning with Bank 0, Bank 4 is actually the fifth bank in the system.

The "20" in the first two examples tell you which chip in the bank (that is, which bit in the 8-bit data byte) is failing. Look at Figure 4-1: the fourth chip from the top of each memory bank is numbered "20".

An error code of "4020" or "40000 20" means that the fourth chip (the chip numbered "20" in Figure 4-1) from the top of the fourth memory bank in the PC is failing. If you have a PC with 256 KB (Banks 0 through 3) installed on its system board, Bank 4 would be the first bank on the SixPakPlus board. The "201" in the error message indicates that there is a problem in memory.

Once you determine which chip you believe is causing the problem, replace it with a spare chip and see if the error is corrected (you can tell that the error is corrected when you reboot your PC and it does not display an error message). If no spare chip is available, try exchanging the suspect chip with another one in the same bank which is not failing. If the error then moves to the new socket, you definitely have a bad chip. If the

error persists at the original socket, you may have a problem with the board; contact your dealer for assistance.

If you get an error message such as "40000 (S) 201", it tells you that you have a memory problem in Bank 4 in your PC; the "(S)" simply means that the failing chip is somewhere in the system unit (that is, somewhere in your computer). The best way to isolate the problem chip is to swap each chip in the failing bank with a good chip and see if the error is corrected.

If you get a "????? 201" error message, it tells you only that you have a memory problem somewhere in your computer. You can try to isolate the problem bank by swapping each memory bank with good memory chips. Once you have determined which memory bank is failing, you can replace each of the original chips and reboot your computer each time you replace a chip. An error message at boot-up then indicates a faulty chip.

If the bit number of the error code does not match any of the values shown in Figure 4-1, you might have more than one failing memory chip. This could be due to a malfunctioning board, incorrect switch settings, multiple bad memory chips, or even something as simple as a dirty gold edge connector.

If the failing bank number is higher than the amount of memory installed in the PC, recheck your system board switch settings.

If you cannot correct the problem, contact your dealer for assistance.

Your SixPakPlus comes standard with one serial port for asynchronous communications. You can use the serial port to connect your PC to a serial printer, modem, or other device which uses an RS-232C interface. The SixPakPlus interface is a DTE type (Data Terminal Equipment) with a male DB25P connector.

This section includes the following information:

- Section 5.1 tells you how to reconfigure the serial port: changing COM1 to COM2, forcing RS-232C inputs true, and disabling the SixPakPlus serial port.
- Section 5.2 discusses serial port programming.
- Section 5.3 gives serial port I/O address assignments and pinouts.
- Section 5.4 discusses serial port diagnostic testing.

5.1 Configuring the SixPakPlus Serial Port

You can install up to two serial ports (called COM1 and COM2) into your PC. The SixPakPlus serial port has been factory configured to respond as COM1 (which uses IRQ4). You can confirm this by checking that shorting plugs are installed at these positions:

- Position 1 (CM1) on the Port Enable Jumper Block
- Position 4 on the IRQ Enable Jumper Block

Figure 5-1 illustrates how to configure the SixPakPlus serial port as COM1 or COM2.

Port enable jumper block

CM1
CM2
LP1
LP2
GME
CLK



Pin CM2-COM2

Pin CM1-COM1
(default position)

IRQ jumper block



IRQ3-COM2

IRQ4-COM1
(default position)

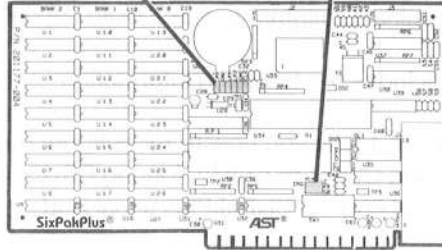

Figure 5-1. Serial Port Factory Configuration.

5.1.1 Installing Multiple Serial Ports in a PC

If your PC already has another card with a serial port on it configured to respond as COM1 (such as the PC XT with its standard serial board), you must change the port on the SixPakPlus to respond as COM2 as shown in Figure 5-1:

- Move the Port Enable Jumper Block shorting plug from CM1 to CM2.
- Move the IRQ Enable Jumper Block shorting plug from 4 to 3.

The SixPakPlus serial port will now respond as COM2.

5.1.2 Configuring the RS-232C Interface Lines

SixPakPlus conforms to the Electronic Industries Association (EIA) RS-232C communication standard, which describes the interface between DTE and Data Communication Equipment (DCE). That means that all inputs to an AST serial port (with the exception of Ring Indicator, pin 22) must be connected to a signal, even if the connected device does not use one or more of the interface lines at connector J1.

NOTE

SixPakPlus does not support the current loop teletype interface.

In the default configuration, SixPakPlus expects the connected device to drive all input signals to its serial ports.

You do not need to change the SixPakPlus default configuration as long as the connected devices drives these serial inputs: Clear to Send (CTS), Data Set Ready (DSR) and Data Carrier Detect (DCD). The device's instructions will tell you if it does not drive these inputs.

If your serial device does not drive these serial port inputs, you can configure the SixPakPlus RS-232C jumper block to "force true" these inputs to the serial port.

The SixPakPlus RS-232C jumper block is divided into three pairs of jumpers. The first two are labelled DSR for Data Set Ready, the second two DCD for Data Carrier Detect, and the last two CTS for Clear to Send. The top jumper of the pair is labelled 1, and it forces the input true. The bottom jumper of the pair is labelled 2

and sets the input to normal. To force all of the inputs true, you would install the shorting plugs on these pins:

DSR Pin 1
DCD Pin 1
CTS Pin 1

Figure 5-2 illustrates how to force one or more of the above signals to always be in the true state. Move the corresponding shorting plug on the RS-232C jumper block (the jumper block near the top of the SixPakPlus board) from the pair of pins labelled 2 ("normal") to the pair of pins labelled 1 ("forced true").

For example, to force the DSR input true, move the shorting plug from position DSR2 to position DSR1.

When you force a signal true, its connection to connector J1 will not affect the function of the serial port.

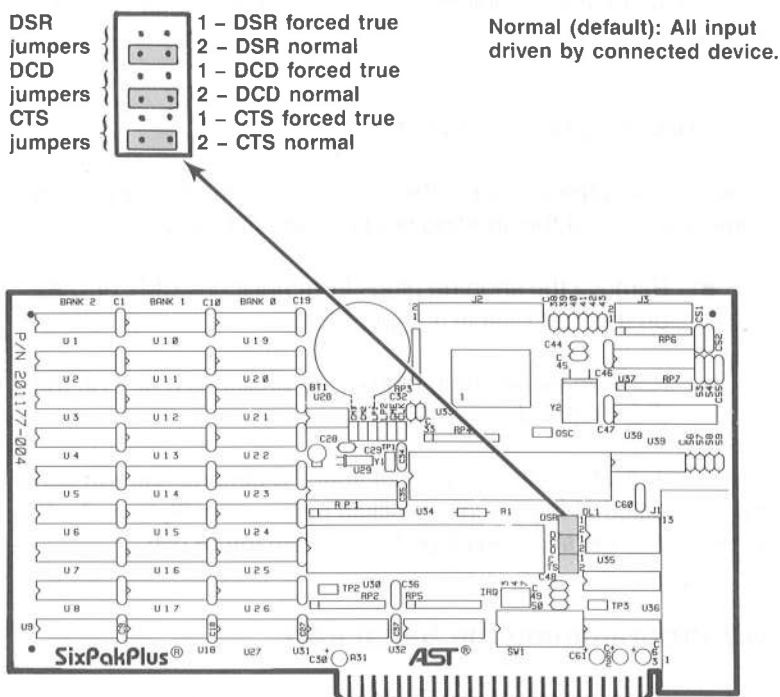

Figure 5-2. Creating a "Forced True" State.

Whether you use the RS-232C jumper block to force certain inputs true depends on what device you connect to the serial port.

You might want to leave the shorting plugs in their "normal" configuration and instead build a special cable for the serial device. This would be especially convenient if you will be using different serial devices on the port at different times.

Appendix B gives general information on building cables. Also refer to the manual supplied with your serial device for help in designing cables.

5.1.3 Disabling the Serial Port

You can completely disable the serial port on the SixPakPlus by removing both of the shorting plugs shown in Figure 5-1:

- Remove the shorting plugs from positions CM1 or CM2 on the Port Enable Jumper Block.
- Remove the shorting plugs from positions 3 or 4 on the IRQ Enable Jumper Block.

You must disable one serial port if your PC already has two serial ports installed; this prevents conflicts between multiple ports. Be sure to save the shorting plugs for possible future use.

5.2 Programming the Serial Port

The serial port on the SixPakPlus is completely under software control, and must be initialized for correct baud rate, parity, number of databits, and number of stopbits before it can be used. You or your software must initialize the serial port each time you turn on the computer.

Typically, the DOS MODE command initializes the serial port (refer to your *DOS Manual* for a detailed explanation of this command). A typical MODE command might look like this:

```
MODE COM1:1200,N,8,1,P < Enter >
```

The above command initializes serial port COM1 for 1200 Baud, no parity, 8 databits, and 1 stopbit. The "P" is optional and tells DOS that you will be using the port with a serial printer. You can also use a similar command to establish communication parameters for serial port COM2.

Many applications programs (such as word processors) automatically handle port initialization, making it unnecessary to use the MODE command. Refer to your software manual; if it does not mention the MODE command, it is probably safe to assume that you can omit that step. If you are unsure, it will not harm anything to go ahead and use the MODE command anyway.

If you are using the serial port to operate a serial printer, you may also need to redirect printer output from LPT1 to COM1 or COM2. This is because DOS always assumes that printer output goes to parallel port LPT1 unless told otherwise. You can use the MODE command to redirect printer output from a parallel port to a serial port. For example:

For printer output to COM1:
MODE LPT1:=COM1:< Enter >

For printer output to COM2:
MODE LPT1:=COM2:< Enter >

A redirection command should follow the first MODE command that sets up the Baud rate, parity, and so forth. Again, it is possible that your applications program is handling this redirection automatically. If so, you can eliminate this step as well.

5.3 Serial I/O Address Assignments and Pinouts

The serial port on the SixPakPlus uses the system I/O addresses and IRQ interrupt request lines shown in Table 5-1.

Table 5-1. I/O Addresses and IRQ Interrupt Requests.

Port Configuration	I/O Addresses	IRQ Line
COM1	03F8-03FFh	IRQ4
COM2	02F8-02FFh	IRQ3

Table 5-2 gives the pinouts for the SixPakPlus serial port connector J1.

Table 5-2. J1 Pinouts.

J1 Pin #	Signal Name	Direction
1	Chassis Ground	-----
2	TX (Transmit Data)	Output
3	RX (Receive Data)	Input
4	RTS (Request to Send)	Output
5	CTS (Clear to Send)	Input
6	DSR (Dataset Ready)	Input
7	SG (Signal Ground)	-----
8	DCD (Carrier Detect)	Input
20	DTR (Data Terminal Ready)	Output
22	RI (Ring Indicator)	Input*

* Ring Indicator connection is not required

5.4 Serial Port Diagnostic Testing

Whenever there is any question about the operation of the SixPakPlus serial port, we recommend that you run the IBM diagnostics, preferably the advanced diagnostics supplied with the IBM *Hardware Maintenance Manual*.

For proper diagnostics operation, disconnect any device connected to the SixPakPlus serial port (such as a modem or serial printer). Also, make sure that the CTS, DSR, and DCD jumpers (Figure 5-2) are in the normal (not "forced true") setting.

You can use a "wrap plug" on the J1 connector to perform a very thorough test of the serial port with the advanced diagnostics. To build this wrap plug, you need a female DB25S connector, such as a Winchester Electronics P/N 49-1125S. Jumper the connector pins as follows:

Pin 2 to Pin 3 (TX to RX)
 Pin 4 to Pin 5 & 22 (RTS to CTS & RI)
 Pin 20 to Pins 6 & 8 (DTR to DSR & DCD)

These jumpers are shown in Figure 5-3.

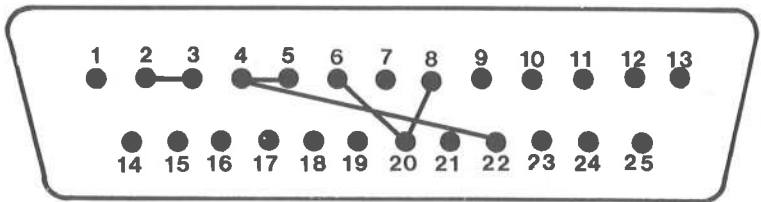

Figure 5-3. Serial Port Loopback Plug Configuration.

When you ready to run the diagnostic program, attach this plug to the SixPakPlus' J1 connector. Run the diagnostic program and answer the Advanced Diagnostics loopback plug question with Y.

Certain versions of the IBM diagnostics may fall on the first pass. You should therefore ignore the results of the first pass if an error occurs.

NOTES

The SixPakPlus comes standard with a parallel port for interfacing the PC to a parallel printer (such as the Epson FX-85™). This port is completely IBM-compatible with the IBM PC and uses the same female DB25S connector as an IBM port.

- Section 6.1 tells you how to configure the parallel port.
- Section 6.2 discusses parallel port programming.
- Section 6.3 gives parallel port I/O address assignments and pinouts.
- Section 6.4 discusses parallel port diagnostic testing.
- Section 6.5 tells you how to configure your SixPakPlus to allow interrupt-driven parallel printer software to operate correctly.

Section 3 of this manual tells you how to install the parallel port ribbon cable onto your SixPakPlus board, and how to install the board and the parallel port into your PC.

6.1 Configuring the Parallel Port

You can install a maximum of three parallel ports in the IBM PC (called LPT1, LPT2, and LPT3). The parallel port on the SixPakPlus has been configured at the factory to respond as LPT1 (LPT2 when a display adapter with a built-in parallel port is present; see Section 6.1.2). You can confirm that the parallel port is configured as LPT1 by checking that a shorting plug is installed at position LP1 of the Port Enable Jumper Block (see Figure 6-1).

Port Enable Jumper Block

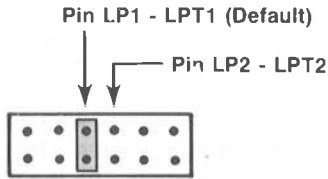

NOTE: When IBM or AST Monochrome Card is installed, SixPakPlus LPT1 automatically responds as LPT2, and SixPakPlus LPT2 automatically responds as LPT3.

Figure 6-1. Parallel Port Factory Configuration.

6.1.1 Installing Multiple Parallel Ports in a PC

If your PC already has another card with a parallel port on it configured to respond as LPT1 you must change one of the boards to respond as LPT2 (this avoids conflicts between the two ports). Display adapters with a built-in parallel port always respond as LPT1 and cannot be changed. To reconfigure the SixPakPlus, move the shorting plug from position LP1 to position LP2 (see Figure 6-1). The parallel port on the SixPakPlus will now respond as LPT2.

6.1.2 Monochrome Adapter Boards

The built-in parallel port on certain display adapter boards (such as the IBM monochrome display/printer adapter or the AST Research MonoGraphPlus™ or Preview!™) always respond as LPT1 and cannot be changed. If you have such a board in your PC, the SixPakPlus parallel port will automatically respond as LPT2 in its factory default configuration. Do not reconfigure the SixPakPlus to respond as LPT2. If you do reconfigure the SixPakPlus for LPT2 when a parallel port that always responds as LPT1 is installed in your PC, the SixPakPlus parallel port will respond as LPT3.

6.1.3 Disabling the Parallel Port

You can disable the SixPakPlus parallel port by removing the shorting plug shown in Figure 6-1. You can disable the parallel port to avoid conflicts when you have several parallel adapters installed in your PC. Save the shorting plug for possible future use.

6.2 Programming the Parallel Port

The IBM PC always sends printer output to parallel port LPT1 unless specifically told otherwise. Unfortunately, PC-DOS 1.0 and 1.1 do not allow you to redirect output from one parallel port to another. Appendix C of this manual tells you how you can cause the PC to redirect printer output from LPT1 to LPT2 or LPT3.

Although it is not required, you can use the DOS MODE command to set the line width and the number of lines per page. Refer to your IBM DOS Manual for more information.

6.3 Parallel Port I/O Addresses and Pinouts

The SixPakPlus parallel port uses the PC I/O addresses shown in Table 6-1.

Table 6-1. Parallel Port I/O Addresses.

Port Configuration	I/O Addresses
LPT1*	0378-037Fh
LPT2*	0278-027Fh

*When you use a display adapter with a built-in parallel port, the PC sees a SixPakPlus parallel port configured for LPT1 as LPT2, and a SixPakPlus parallel port configured for LPT2 as LPT3.

You can use the standard IBM Parallel Printer Cable to connect the SixPakPlus to an IBM or IBM-compatible printer. You can also use the information in Table 6-2 to help build a cable for your parallel printer.

Table 6-2. Parallel Port Pinouts.

Line Name	AST Adapter Cable		
	J2 Pin	Output DB25S	IBM Matrix Printer Centronics Interface
-STROBE	1	1	1
D0	3	2	2
D1	5	3	3
D2	7	4	4
D3	9	5	5
D4	11	6	6
D5	13	7	7
D6	15	8	8
D7	17	9	9
-ACK	19	10	10
BUSY	21	11	11
PE	23	12	12
SLCT	25	13	13
-AUTOFD	2	14	14
-ERROR	4	15	32
-INIT	6	16	31
-SLCT IN	8	17	36
GROUND	(10) 12,14,16, 18,20 22,24)	(18-25)	(16,19-30 33)

NOTE

A dash in front of the line name denotes lines which are functionally active when low.

6.4 Parallel Port Diagnostic Testing

The parallel port on your SixPakPlus is compatible with the IBM diagnostics. However, you must configure the parallel port as LPT1 so that the port can be recognized by the diagnostics.

To run the diagnostics you must provide incoming signals to the port by installing a wrap plug in the parallel port connector. To construct a wrap plug connect the following pins on a DB25P (male) connector. Use 30AWG (minimum) wire to make the connections.

- Pin 1 to Pin 13
- Pin 2 to Pin 15
- Pin 10 to Pin 16
- Pin 11 to Pin 17
- Pin 12 to Pin 14

These jumpers are illustrated in Figure 6-2.

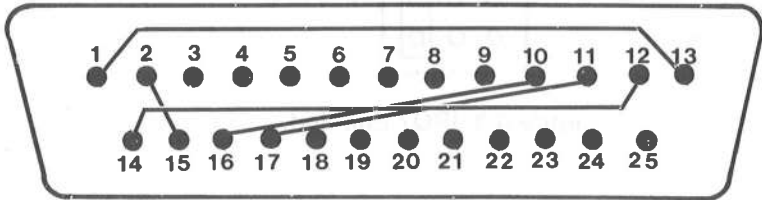

Figure 6-2. Parallel Port Loopback Plug Configuration.

NOTE

You cannot perform the IBM diagnostics on the parallel port if you have installed the IBM Monochrome Display/Printer Adapter.

If you run the matrix printer test, your printer must be 100% compatible with an Epson MX-80 or errors can be generated.

6.5 Interrupt-Driven Parallel Printer Software

Interrupt-driven parallel printer software uses IRQ7. To ensure that your Interrupt-driven parallel printer software operates correctly, you must enable IRQ7 on the SixPakPlus, as shown in Figure 6-3. It will not harm anything to enable IRQ7 even if you do not run interrupt-driven software for your parallel printer.

IRQ Jumper Block

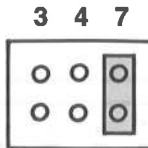

Figure 6-3. IRQ7 Enabled.

The SixPakPlus game port provides an interface for connecting one or two joysticks to your PC. With appropriate software, the joystick can be used for cursor control, as well as graphics development and interactive games.

This section includes the following:

- Section 7.1 tells you how to enable or disable the game port.
- Section 7.2 discusses software compatibility.
- Section 7.3 gives the I/O address assignment and pinouts for the game port.
- Section 7.4 discusses game port diagnostic testing.
- Section 7.5 gives you the information you need to upgrade the SixPakPlus to add the game port.

7.1 Configuring the SixPakPlus Game Port

To enable the game hardware: The game port ribbon cable must be installed on your SixPakPlus board (as described in Section 2 of this manual), and the proper shorting plug must be installed on the Port Enable Jumper Block Pin GME, as shown in Figure 7-1.

The game port hardware must be installed on the board (Section 7.5 provides information on adding the port to your SixPakPlus).

Port enable jumper block

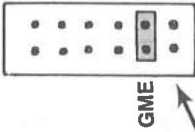

Pin GME – Game port enable
(Install shorting plug to enable game port.
Remove shorting plug to disable game port.)

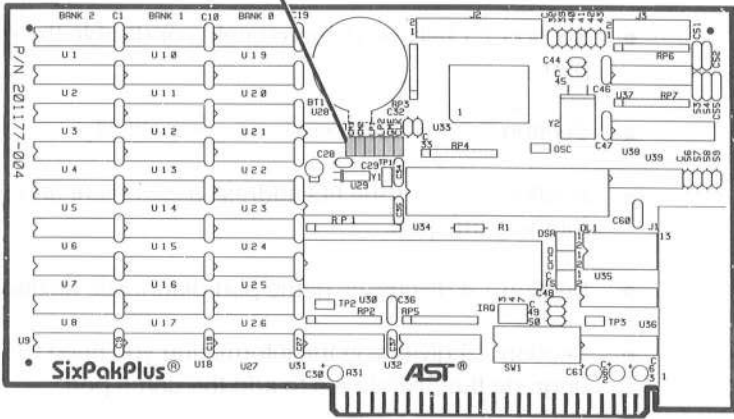

Figure 7-1. Game Port Enable/Disable.

To completely disable the SixPakPlus game port: Remove the jumper shown in Figure 7-1.

7.2 Software Compatibility

The game port is totally software-compatible with the IBM game adapter. Because joysticks are analog devices, the function of some software can vary with the joystick used, even though the game port is functioning properly. To compensate for differences

between joysticks, use software that includes a joystick centering function.

You can use the program listing in Section 7.4 to test the correct operation of the SixPakPlus game port.

7.3 Game Port Technical Information

This section provides technical information about the SixPakPlus game port.

7.3.1 Game Port I/O Address Assignment

The game port uses I/O address 0201h. This information is for technical reference only; you do not need to know the I/O address to use the game port.

7.3.2 Game Port Pinouts

The SixPakPlus game port uses a DB15S (socket or female) interface connector to enable the connection of up to two joysticks. Table 7-1 summarizes the game port pinouts.

Table 7-1. SixPakPlus Game Port Pinouts.

	SixPakPlus J3 Pin No.	DB15S Pin Number	Signal Name
Joystick A	1	1	+5VDC
	3	2	Button 1
	5	3	X Axis
	7	4	Ground
	9	5	Ground
	11	6	Y Axis
	13	7	Button 2
	15	8	+5VDC
Joystick B	2	9	+5VDC
	4	10	Button 1
	6	11	X Axis
	8	12	Ground
	10	13	Y Axis
	12	14	Button 2
	14	15	+5VDC

You can connect one joystick directly to the DB15S connector. To connect two joysticks, you will need a Y-connector adapter cable. The adapter cable should have one DB15S connector (to the SixPakPlus) and two DB15P connectors (to the joysticks). Pins 1 through 8 on the DB15S should connect to one DB15P, and pins 9 through 15 to the other, as shown in Table 7-1. Consult your dealer for further information.

7.4 Game Port Diagnostic Testing

You can use the IBM diagnostics to test the SixPakPlus game adapter port. Because of a problem in the diagnostic program, however, the port may not always show up on the listing of installed devices. You might prefer to use the program below to test out the port. This program requires the use of BASICA (not BASIC).

```

10 DEFINT A-Z:KEY OFF:CLS:STRIG ON:SCREEN 2
20 PRINT " X1"," Y1"," X2"," Y2"," S1"," S2"," S3"
30 X1 = STICK(0):Y1 = STICK(1):X2 = STICK(2):Y2 = STICK(3)
40 A = STRIG(1):C = STRIG(5):C = STRIG(3):D = STRIG(7)
50 LOCATE 3:PRINT X1,Y1,X2,Y2,A;B;C;D
60 GOTO 30

```

When you run the above program, moving the joystick in the X-plane (left-right) causes a change in the "X1" readout, while moving the joystick in the Y-plane (up-down) causes a change in the "Y1" readout. Pressing the switch (either one or two, depending on your joystick) causes a change in the "S1" or "S3" readouts from 0 to -1. Note that, depending on the quality of your joystick, you may not be able to get a zero reading in the X and Y planes when running the program. This is normal and no cause for alarm.

7.5 Adding the Game Port to Your SixPakPlus

AST Research offers an upgrade kit for field installation of the SixPakPlus game port. To order the game port upgrade kit: order model number SPK-000G through your AST dealer. The upgrade kit consists of a 16-pin IC (No. 558CP) and a 20-pin IC (No. 74LS244). To install the game port, follow the procedure described below.

CAUTION

Be sure the power switch is off and the power cord is removed from the system unit. Turn off any other equipment connected to the computer. Installing any component while the power is on can permanently damage your computer and its components.

STEP 1

Remove the PC's system unit cover: Follow the instructions in STEP 1 and STEP 2 of Section 2.3.

STEP 2

Remove devices attached to the SixPakPlus board: If you have installed the parallel port, remove the the ribbon cable attached to the SixPakPlus board. Disconnect any serial device connected to the serial port.

STEP 3

Remove the SixPakPlus board: Remove the bracket retaining screw from the bracket securing the SixPakPlus board to the PC chassis. With a steady, evenly distributed upward tension, remove the SixPakPlus board from its slot.

STEP 4

Install the game port ICs: Your game port upgrade kit comes with two ICs: a 16-pin and a 20-pin IC. Each IC is labelled with a notch or a small dot to identify the bottom left. Insert the ICs as follows. It is very important that you do not bend any pins when you insert your ICs.

With the notch (or dot) on the bottom left, insert the 16-pin IC in socket U37, as shown in Figure 7-2.

With the notch (or dot) on the bottom left, insert the 20-pin IC in socket U38, as shown in Figure 7-2.

U37: Install 16-pin IC
(No. 558CP) here.

U38: Install 20-pin IC
(No. 74LS244) here.

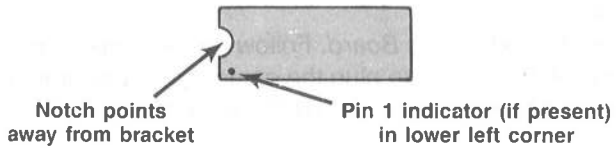
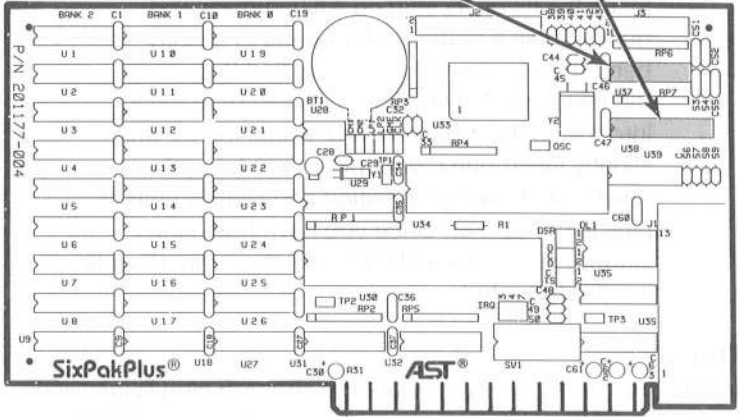

Figure 7-2. Installing the Game Adapter Port ICs.

NOTE

If the IC seems too wide to allow the pins to properly line up with their socket receptacles, place the IC on its side on a flat surface and gently angle it under both thumbs to slightly bend the pins inward. You may find this same technique useful when actually inserting the IC into the socket on the board. Angle the IC, and slightly insert one row of pins, then bring the other row down into position and slightly start its pins in the socket. Once you have both sides started, you can evenly depress the entire IC until it is firmly seated.

STEP 5

Enable the game port: Make sure the shorting plug is installed across Pin GME of the port enable jumper block, as shown in Figure 7-1.

STEP 6

Replace the SixPakPlus Board: Follow the instructions in Section 2.4. Make sure to plug the game port connector onto connector J3, as described in STEP 1 of Section 2.4.

STEP 7

Configure the game port: Follow the instructions in Section 7.1.

PART III. APPENDICES

- A. Troubleshooting and Repair Procedure
- B. Serial Interface
- C. Switching Between Parallel Ports
- D. Installing SixPakPlus in the Older 64-KB IBM PC

NOTES

This section outlines some simple procedures for troubleshooting when you have a problem with your SixPakPlus. It also describes the procedure for returning your SixPakPlus to the factory should it require repairs.

A.1 Troubleshooting

The following outlines some suggestions for solving common difficulties with the SixPakPlus.

PROBLEM: Power-up Self Test fails.

ACTION: A parity error or interrupt conflict can prevent the self test from successfully completing. To determine the area of difficulty, disable all features on the SixPakPlus by removing the appropriate jumpers/plugs on the port enable jumper block (refer to Figure 2-2). Then enable each feature one by one, rerunning the self test each time, until you isolate the problem area.

PROBLEM: Parallel port doesn't work.

ACTION: Check the following:

- Check that the device connected to the port works and is powered on.
- Check cabling: Check cables between the parallel port and peripheral device; check that the ribbon cable to the parallel port connector is securely attached to the SixPakPlus board.
- Check that the software you are using is sending output to the correct device. SixPakPlus is usually configured so that the parallel port appears as LPT1. Go over the

procedures in Section 6 to make certain the port is configured as you intended. Check your software to see to which device it is sending output.

- Make sure the parallel port is enabled. Check that the shorting plug shown in Figure 6-1 is installed (Section 6.1.3).
- Check that IRQ7 is enabled (Section 6.5).

PROBLEM: Serial Port doesn't work.

ACTION: Check the following:

- Check that the device connected to the serial port is powered on and working.
- Check cabling: check cabling between the serial port and the peripheral device (see Appendix B).
- Check that the software you are using is sending output to the correct device. The SixPakPlus is usually configured so that the serial port appears as COM1. The port expects the connected device to drive all serial inputs. Go over the procedures in Section 5.1 to make certain the port is configured as you expect. Check your software to see to which device it is sending output. If you are using a serial printer, you may need to direct printer output from LPT1 to COM1 or COM2 (see Section 5.2).
- Check the jumper positions on the Port Enable Jumper Block, and the IRQ Jumper Block (Section 5.1).
- Make certain the serial port is correctly initialized (Section 5.2). Check that the Baud rate, parity, number of data bits, and number of stop bits for the peripheral device match what you specified in your DOS MODE command, or what your software specified for you.

PROBLEM: Game port doesn't work.

ACTION: Check the following:

- Check that the device connected to the game port is powered on and working.
- Check cabling: check cabling between the game port and the peripheral device; check that the ribbon cable to the game port connector is securely attached to the SixPakPlus board.
- Make certain the game port is installed and enabled. Section 7.1 describes the jumper plug that should be installed. ICs should be installed in sockets U37 and U38 (Section 7.5).

PROBLEM: Memory errors.

ACTION: Check the following:

- Check settings on SixPakPlus switch SW1 (Section 2.2).
- Check settings on PC system boards (Section 2.3).
- Perform procedures outlined in Section 4.3.

PROBLEM: DOS or ASTCLOCK displays incorrect time or date.

ACTION: Do the following:

- Set the correct time and date as described in Section 3.3.
- Replace the clock-calendar battery (Section 3.4), then reset the clock (Section 3.3).

A.2 Product Repair Procedure

If your AST Research product ever requires repair, contact your dealer first. The dealer from whom you originally purchased the product can usually service the product. If you must return a hardware product to the factory for service, follow these guidelines to ensure rapid, accurate turnaround:

1. *Call AST Research Technical Support for a Return Authorization Number (RAN):* A technician will discuss the problem with you; if factory service is required, the technician will give you a Return Authorization Number (RAN). Always refer to the RAN when you return anything for service. AST Research will return anything without a RAN to the sender.
2. *If the product is covered under an AST Research warranty:* There is no charge for parts or labor involved in the repair. Please include a copy of your original purchase receipt as the proof of date of purchase for all warranty repairs.

If the product is not covered under an AST Research warranty: Contact your dealer or AST Research Technical Support for further information.

3. *Parts not covered under the warranty:* Dealer- or user-installed parts (such as RAM chips) are not covered under the terms of the warranty. Dealer-installed parts are warranted by the dealer; parts that you install are covered only by the parts suppliers' warranties. If we find that your dealer or user-installed parts are defective, we can identify which parts are defective, but we will not replace parts unless you specifically authorize us to do so in writing when you send the board to us. The parts charges and any applicable labor charges will be billed COD.
4. *Describe the problem and return any related accessories:* Please include a brief but explicit written description of the problem when you return your AST

product to the factory for repair. Also return any accessories that might relate to the problem. For example, if the the parallel port does not function correctly, be sure to return the parallel port adapter cable with the board.

5. *Be sure to provide a return shipping address that UPS can deliver to and include your RAN:* UPS cannot normally deliver to post office boxes. Reference the RAN issued to you by AST Technical Support on all correspondence. Securely package all materials to prevent shipping damage. Shipping charges must be prepaid; CODs will not be accepted. Ship the materials to the following address:

AST Research, Inc.
Customer Service RAN xxxx
2722 Michelson Drive
Irvine, CA 92715

where xxxx is your assigned Return Authorization Number.

6. Once your product is repaired, we will return it to you by UPS or UPS Blue Label service, whichever is appropriate for your geographical location. We will return items covered by warranty at our expense. Shipping costs and repair expenses for items not covered by warranty will be billed COD. If you prefer overnight service (UPS Red Label), the shipping charges will be billed COD. If you want us to ship Federal Express, please give us your Federal Express account number for billing purposes.

NOTES

This appendix provides general information on wiring the SixPakPlus serial port to other serial devices (such as printers, plotters, or modems), including:

- The RS-232C serial interface standard (Section B.1).
- Interfacing DTE to DCE (Section B.2).
- Interfacing DTE to DTE -- "null modem" (Section B.3).
- Designing your own serial interface (Section B.4).

The SixPakPlus serial port is completely IBM-compatible. In most cases, you can connect your remote device to the SixPakPlus serial port with a cable provided with the device itself. Simply refer to the instructions provided with the device or with the software for driving it.

In some cases, your instructions will specify how your remote device uses RS-232C line signals and which pin numbers supply which signals. With this information, plus the information in this appendix, you can construct an interface cable yourself.

NOTE

Serial devices use RS-232C signals in different ways. AST Research cannot tell you how to connect a particular device to your serial port. You must refer to the manufacturer's instructions that came with that device.

The SixPakPlus serial port does not support the current loop teletype interface.

B.1 RS-232C Interface Standard

SixPakPlus connects to other serial devices according to the Electronic Industry Association (EIA) RS-232C interface standard.

The RS-232C standard describes the sequence of signals that travel between two serial devices. The signals control the exchange of data between serial devices. RS-232C defines 20 signals (although few applications use all 20), and each signal travels separately on a predefined wire.

The RS-232C standard classifies communications devices as:

- *Data terminal equipment (DTE)*: Equipment associated with the user, such as a PC or a mainframe computer. The SixPakPlus serial port is a DTE device.
- *Data communications equipment (DCE)*: Equipment associated with transmission facilities, such as a modem.

The RS-232C standard describes the ideal case, where a DTE device connects to a DCE device. Before sending data, the SixPakPlus serial port must send and receive RS-232C signals in this order:

1. Some DCE devices use the Ring Indicator (RI) signal to alert SixPakPlus that incoming data is due.
2. SixPakPlus sends Data Terminal Ready (DTR) to signal a request for a communications link.
3. SixPakPlus receives Data Carrier Detect (DCD) and Data Set Ready (DSR) -- these signals indicate that the DCE is ready.
4. SixPakPlus sends Ready To Send (RTS) -- this signal tells the DCE that SixPakPlus is ready to send data.
5. SixPakPlus receives Clear To Send (CTS) -- a signal from the DCE to go ahead and transmit data.

6. SixPakPlus then starts transmitting data via the Transfer Data (TxD) signal. SixPakPlus receives data via the Receive Data (RxD) signal.

To prevent damage to either device, the chassis ground and signal ground signals must always be connected. For the SixPakPlus serial port, connecting to pin 1 or pin 7 or both makes the connection to chassis ground and signal ground.

You can think of certain pins on one side of the interface as "functional pairs":

DTE	DCE
DTR-----	DSR and DCD
RTS-----	CTS
TxD-----	RxD

B.2 Interfacing DTE to DCE

An example of a DTE-to-DCE interface that conforms to the RS-232C standard would be to connect the SixPakPlus serial port (DTE) to a telephone modem (DCE). A correctly configured DCE/DTE interface is wired straight across: DTE pin 20 wired to DCE pin 20, pin 2 to pin 2, and so forth.

Two serial devices interact in a certain sequence -called "handshaking" -to function properly:

1. Some modems (DCE) have an automatic answer mode that uses the signal RI to alert the DTE that incoming data is due. SixPakPlus (the DTE) would then use DTR to respond to RI.
2. When the SixPakPlus serial port (DTE) wants to send or receive data it raises the voltage on pin 20; pin 20 carries the DTR signal. This voltage travels to DCE pin 20 where the modem interprets it to mean that a communications link is being requested by the DTE device.

3. If an open phone line exists, the DCE brings up two lines on its side of the interface: DSR and DCD.
4. When the DTE sees high voltage at its pins 6 and 8, it can then bring up pin 4, RTS. RTS tells the DCE that the DTE has data to transmit to it.
5. The DCE checks that it is ready to receive data; if so, it brings up pin 5, CTS.
6. Once the DTE sees voltage on its pin 5, it can transmit data on the wire connected to pin 2, TxD -or it can receive data via RxD.

CAUTION

To help protect your equipment from damage, be sure to connect the ground wires (pins 1 and/or 7).

Figure B-1 shows an ideal DTE-to-DCE interface, including signals, signal directions, and sequence (top to bottom). The interface must handle these signals before the DTE can transmit or receive data:

- DCD, DSR, CTS, and RxD are input signals to the SixPakPlus.
- DTR and RTS are output signals from the SixPakPlus.

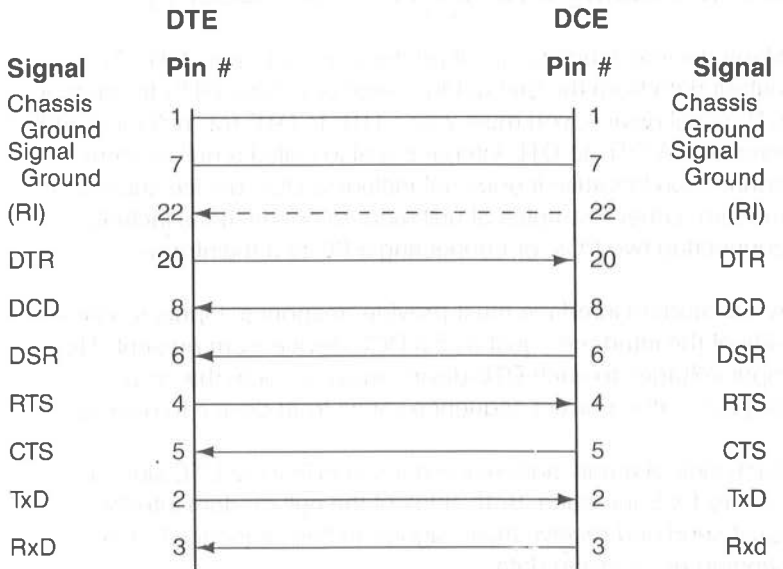

Figure B-1. DTE-to-DCE Interface.

Figure B-1 shows the interface signals in order of occurrence (top to bottom). From the DTE's standpoint, it must send DTR, see DCD, see DSR, send RTS, and see CTS before transmitting or receiving data.

The DTE inputs must have voltage applied to them for the interface to become operational (the DTE outputs are necessary only because they are inputs to the DCE side of the interface). The DTE hardware does not release data to the communications link until it has received the proper set and sequence of signals.

B.3 Interfacing DTE to DTE ("Null Modem")

Many devices (such as serial printers) are set up as DTE. To output data from the SixPakPlus serial port (also DTE) to another DTE serial device, you must wire a DTE to DTE (or "null modem") interface. A DTE-to-DTE interface is also called a null modem connection because it does not include a DCE device such as a modem. Other examples of null modem connections include connecting two PCs, or connecting a PC to a mainframe.

A null modem interface must provide "response" inputs to either side of the interface -- just as if a DCE device were present. The input voltages to each DTE device must occur in the correct sequence (the correct sequence varies from device to device).

Each side of a null modem interface acts like the DTE side of a DTE-to-DCE interface. Both sides of the null modem interface must send and receive these signals in this sequence before sending or receiving data:

- Send DTR
- Receive DCD and DSR
- Send RTS
- Receive CTS

Figure B-2 shows a standard null modem configuration, including signal directions and sequence.

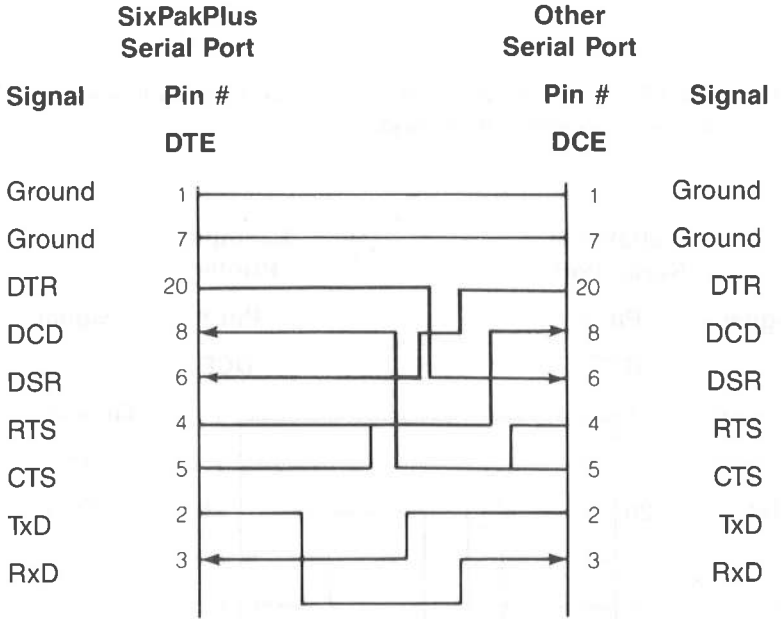

Figure B-2. Example #1: Null Modem (DTE-to-DTE) Interface.

Figure B-3 illustrates another null modem interface, including the direction and sequence of the signals.

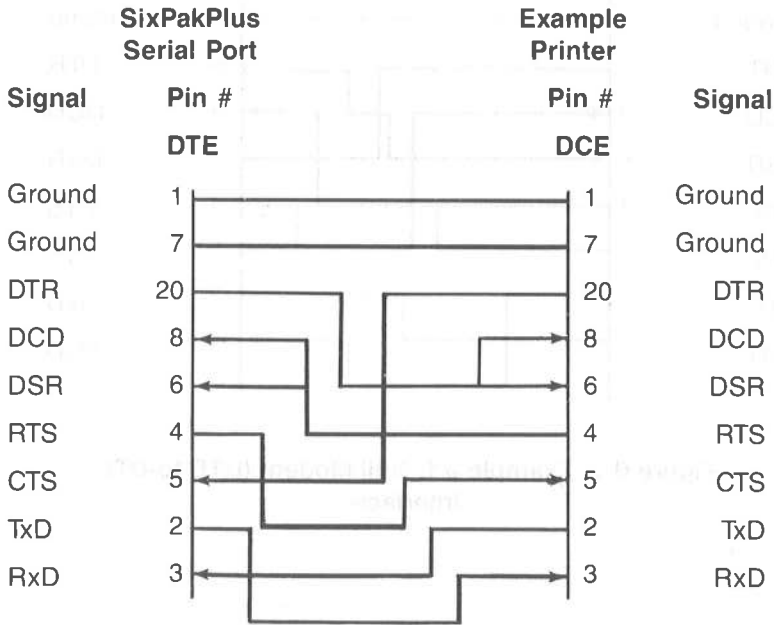

Figure B-3. Example #2: Null Modem Interface.

Notice that the necessary input signals are supplied to both sides. DCD, DSR, and CTS have voltage applied to them on either side.

The example shown in Figure B-3 changes the ideal sequence by having the printer DTR signal drive PC signal CTS. The chip that

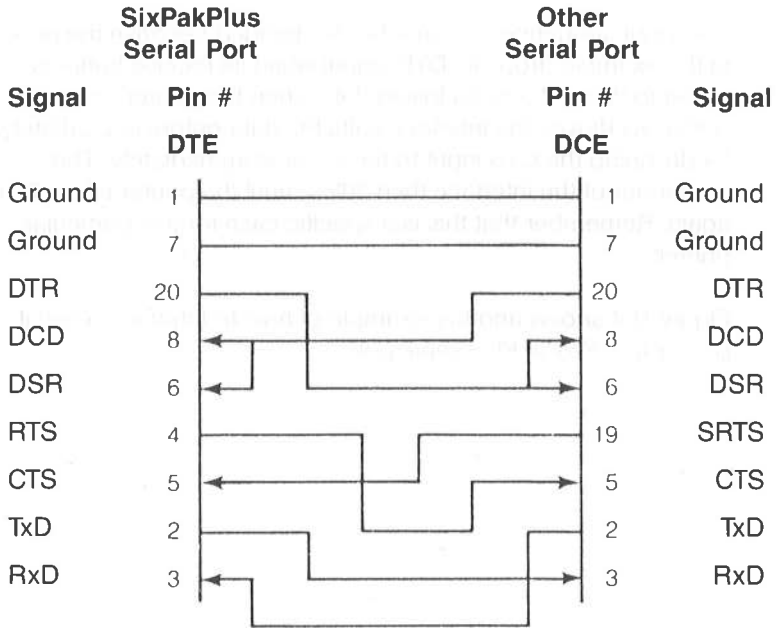

Figure B-4. Example #3: Null Modem Interface.

In this case, the printer uses SRTS (Secondary Request to Send, pin 19) instead of pin 4 (RTS); apart from that exception, Figure B-3 follows the ideal DTE Input and sequence rules.

The advantage of the interface shown in Figure B-4 is that every pin is driven by its functional counterpart on the other side of the interface; the functionally related signal pairs include DTR/DSR, RTS/CTS, and TxD/RxD. This should also hold true for the interface you design.

B.4 Design Aids

Your serial device manual tells you how the device uses the RS-232C line signals and which pin numbers supply which signals. You can also contact the device manufacturer for further information on interfacing to an IBM PC asynchronous serial port. Serial ports on all AST Research boards are IBM-compatible.

Your dealer can direct you to a parts store that carries the products you need to construct an interface cable. You must use the correct type of 25-pin connectors (male or female) to connect both ends properly. The SixPakPlus serial port end plugs into a DB25S (female/socket type) connector.

To wire your serial interface signals properly, we suggest you use the form shown in Figure B-5 as a design aid.

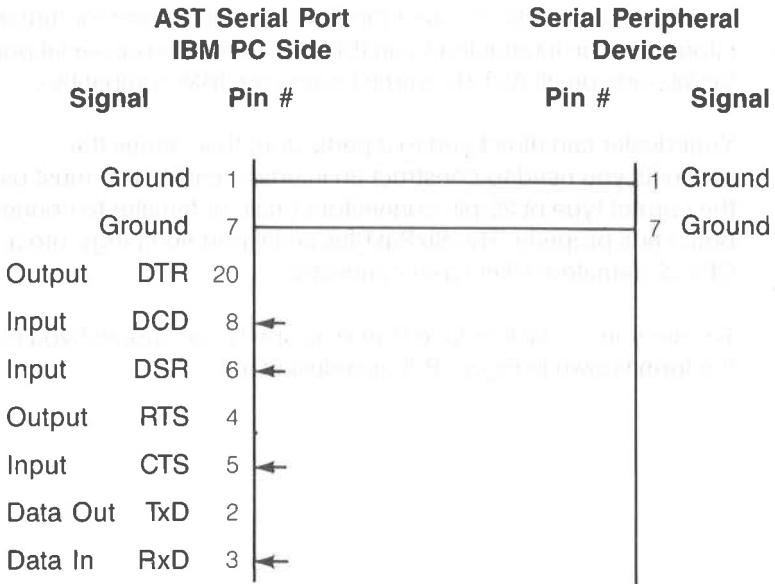

Figure B-5. Serial Interface Form.

If you plan to use several different serial devices on your serial port, you can make a separate interface assembly for each device. That way you can use the same long cable to connect your PC to any of these devices.

SWITCHING BETWEEN PARALLEL PRINTER PORTS

C

This appendix gives you programs you can use in a batch file to direct printer output normally designated for the device attached to port LPT1, to instead be routed to the device attached to port LPT2 or LPT3. (The program also directs output, normally designated for the device attached to port LPT2 or LPT3, to instead be routed to the device attached to port LPT1.) For more information on creating a batch file, see your *IBM DOS Manual*.

The programs in this appendix are particularly useful if your applications program (a word processing program, for example) is capable of sending print output to only one parallel port. You might also use this program when your LPT1 printer (call it printer #1) is down for service, or when you want to take advantage of the type style or speed of the printer attached to LPT2 or LPT3 (call it printer #2 or #3). This program allows you to quickly switch between outputs without having to alter your hardware interface or change each line in programs where LPT1, LPT2, or LPT3 appear as your output port designation.

If your printers are not configured to the same parameters, as defined in the DOS MODE command, you must add two MODE statements when switching devices.

Notice that the "swap" program below is written in BASIC. Since the printer port swap is best handled in DOS, BASIC is invoked within the .BAT file. No RUN command is required when the BASIC call and the program file name occur on the same line (**BASIC LPTSWAP**). Consult your *IBM BASIC Manual* if you have any questions about entering and saving the LPTSWAP.BAS program.

C.1 Switching Between LPT1 and LPT2

The following DOS batch file and BASIC program redirects printer output from LPT1 to LPT2 or vice versa, depending on which port is being used at the time.

LPTSWAP.BAT (or a name of your choosing) with the following:

```
MODE LPT1:[parameters for printer #2 (if needed)]
MODE LPT2:[parameters for printer #1 (if needed)]
BASIC LPTSWAP
```

LPTSWAP is a BASIC program, as shown below. The comments are included for clarification and need not be included in the actual program.

```
10 DEF SEG = &H40                                ' finds port address table
20 A = PEEK (8): B = PEEK (9)                    ' save LPT1 address
30 POKE 8,PEEK (10): POKE 9,PEEK (11)          ' LPT2 address to LPT1
40 POKE 10,A: POKE 11,B                         ' LPT1 address to LPT2
50 SYSTEM                                       ' return to DOS
```

Omit statement 50 if you will be LPRINTing from BASIC.

C.2 Restoring LPT1 to LPT1 and LPT2 to LPT2

Use the same program, LPTSWAP, to restore your parallel printer ports to their original arrangement. Be sure to restore the proper parameters using a new batch file and MODE statements.

LPTRSTR.BAT is as follows:

```
MODE LPT1:[parameters for printer #1 (if needed)]
MODE LPT2:[parameters for printer #2 (if needed)]
BASIC LPTSWAP
```

C.3 Switching Between LPT1 and LPT3

The following DOS batch file and BASIC program redirects printer output from LPT1 to LPT3 or vice versa, depending on which port is being used at the time.

LPTSWAP.BAT (or a name of your choosing) with the following:

```
MODE LPT1:[parameters for printer #3 (if needed)]
MODE LPT3:[parameters for printer #1 (if needed)]
BASIC LPTSWAP
```

LPTSWAP is a BASIC program, as shown below. The comments are included for clarification and need not be included in the actual program:

```
10 DEF SEG = &H40                                ' finds port address table
20 A = PEEK (8): B = PEEK (9)                    ' save LPT1 address
30 POKE 8,PEEK (12): POKE 9,PEEK (13)          ' LPT3 address to LPT1
40 POKE 12,A: POKE 13,B                          ' LPT1 address to LPT3
50 SYSTEM                                        ' return to DOS
```

Omit statement 50 if you will be LPRINTing from BASIC.

C.4 Restoring LPT1 to LPT1 and LPT3 to LPT3

Use the same program, LPTSWAP, to restore your parallel printer ports to their original arrangement. Be sure to restore the proper parameters using a new batch file and MODE statements.

LPTRSTR.BAT is as follows:

```
MODE LPT1:[parameters for printer #1 (if needed)]
MODE LPT3:[parameters for printer #3 (if needed)]
BASIC LPTSWAP
```

NOTES

1. The following information is provided for your reference only. It is not intended to be used as a substitute for the information provided in the main text of the document.

2. The following information is provided for your reference only. It is not intended to be used as a substitute for the information provided in the main text of the document.

3. The following information is provided for your reference only. It is not intended to be used as a substitute for the information provided in the main text of the document.

4. The following information is provided for your reference only. It is not intended to be used as a substitute for the information provided in the main text of the document.

5. The following information is provided for your reference only. It is not intended to be used as a substitute for the information provided in the main text of the document.

6. The following information is provided for your reference only. It is not intended to be used as a substitute for the information provided in the main text of the document.

7. The following information is provided for your reference only. It is not intended to be used as a substitute for the information provided in the main text of the document.

8. The following information is provided for your reference only. It is not intended to be used as a substitute for the information provided in the main text of the document.

9. The following information is provided for your reference only. It is not intended to be used as a substitute for the information provided in the main text of the document.

10. The following information is provided for your reference only. It is not intended to be used as a substitute for the information provided in the main text of the document.

INSTALLING SIXPAKPLUS IN THE OLDER 64-KB IBM PC

D

This appendix provides instructions for configuring and installing SixPakPlus if you have an original (64 kilobyte (KB) system board) IBM PC.

Definition: The original PC has 64 KB of memory on its system board. The system board switches on the 64-KB PC can be set for a maximum of 544 KB. However, it is possible to install up to 640 KB in the 64-KB PC; you must install the IBM BIOS ROM Upgrade Kit (IBM P/N 1S01005) to enable a full 640 KB to be recognized.

Configuration and installation: Follow this procedure to configure and install SixPakPlus in the older PC:

STEP 1

Configure SixPakPlus for the starting address (64 KB), the amount of SixPakPlus memory, and parity check enable/disable. Section 2 tells you how to configure the SixPakPlus.

The only special instruction for the 64-KB PC is that the SixPakPlus starting address is always 64 KB (unless another memory expansion board is installed starting at 64 KB). If another memory board is installed starting at 64 KB, set the SixPakPlus starting address at the end of installed memory.

STEP 2

Open the PC. Section 2 (as well as the IBM PC Guide to Operations) tells you how to open the PC. The procedure for opening the original PC is the same as for the latter (256-KB system board) PC.

STEP 3

Set the PC system board switches for the total amount of memory and the number of disk drives (if you are adding SuperDrive). Set switch SW2 (shown in Figure D-1) on the system

board for the total amount of memory in the PC (including system memory and all expansion memory).

Total Memory	SW2-1	SW2-2	SW2-3	SW2-4
64 KB	ON	ON	ON	ON
128 KB	ON	OFF	ON	ON
192 KB	ON	ON	OFF	ON
256 KB	ON	OFF	OFF	ON
320 KB	ON	ON	ON	OFF
384 KB	ON	OFF	ON	OFF
448 KB	ON	ON	OFF	OFF
512 KB	ON	OFF	OFF	OFF
544 KB	OFF	OFF	OFF	OFF

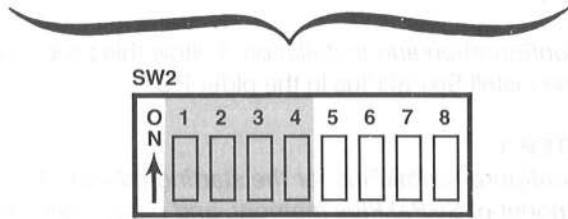

Figure D-1. Switch Setting SW2 for Total Memory in the PC.

Some applications programs available for the PC do not work correctly when the switches are set for 544 KB. You should therefore use the 512-KB setting even if you have more than 512 KB installed in your 64-KB PC. SuperDrive and SuperSpool (as well as certain other programs) can still use the excess beyond the 512-KB setting.

If your original PC is equipped with the IBM Expansion Unit and has the new read-only memory basic input output system (ROM BIOS) installed, you can address a full 640 KB, and you should use the switch settings for the latter (256-KB) PC (see Section 2).

Set SW-1 (Figure D-2) on the system board for the number of disk drives (including floppy and SuperDrives).

Number of Drives	System Board Switch SW1	Floppy/SuperDrive Designations	IBM Fixed Disk Designation
1		A:	C:
2		A:B:	C:
3		A:B:C:	D:
4		A:B:C:D:	E:

Figure D-2. Switch Setting SW1 for Number of Disk Drives (If Installing SuperDrive).

STEP 4

Install the SixPakPlus board in your PC. The procedure for installing SixPakPlus in the older 64-KB PC is the same as for the later (256-KB system board) PC.

Troubleshooting Memory Problems: The troubleshooting procedure for memory problems (described in Section 4.3) is the same for the 64-KB PC as for other PCs.

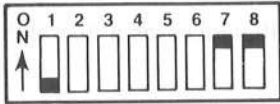
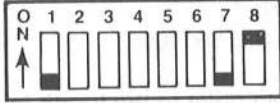
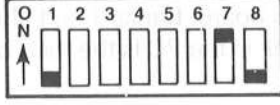
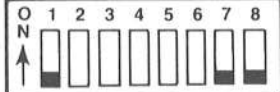
The only special point to remember is that the first 64-KB memory bank (Bank 0) in your PC will always be system memory. All other memory banks will then refer to expansion memory.

For example, if you have a 64-KB PC that includes a SixPakPlus with 384 KB of memory:

Bank 0 is on the system board.

Banks 1 through 6 are on the SixPakPlus.

An error message like "3020 201" would point to the fourth bank in an 64-KB PC. Bank 0 is on the system board. Banks 1 and above are on the SixPakPlus. The fourth bank in the PC is the third bank on the SixPakPlus.

LIMITED WARRANTY

AST Research, Inc. warrants to the original purchaser of this AST Research, Inc. product that it is to be in good working order for a period of 2 years from the date of purchase from AST Research, Inc. or an authorized AST Research, Inc. dealer. Should this product, in AST Research, Inc.'s opinion, malfunction during the warranty period, AST will, at its option, repair or replace it at no charge, provided that the product has not been subjected to misuse, abuse, or non-AST authorized alterations, modifications, and/or repairs.

Products requiring Limited Warranty service during the warranty period should be delivered to AST with proof of purchase. If the delivery is by mail, you agree to insure the product or assume risk of loss or damage in transit. You also agree to prepay shipping charges to AST.

ALL EXPRESS AND IMPLIED WARRANTIES FOR THIS PRODUCT INCLUDING, BUT NOT LIMITED TO, THE WARRANTIES OF MERCHANTABILITY AND FITNESS FOR A PARTICULAR PURPOSE ARE LIMITED IN DURATION TO THE ABOVE 2 YEAR PERIOD. Some states do not allow limitations on how long an implied warranty lasts, so the above limitations may not apply to you.

UNDER NO CIRCUMSTANCES WILL AST RESEARCH, INC. BE LIABLE IN ANY WAY TO THE USER FOR DAMAGES, INCLUDING ANY LOST PROFITS, LOST SAVINGS OR OTHER INCIDENTAL OR CONSEQUENTIAL DAMAGES ARISING OUT OF THE USE OF, OR INABILITY TO USE, SUCH PRODUCT. Some states do not allow the exclusion or limitation of incidental or consequential damages for consumer products, so the above limitations or exclusion may not apply to you.

THIS WARRANTY GIVES YOU SPECIFIC LEGAL RIGHTS, AND YOU MAY ALSO HAVE OTHER RIGHTS WHICH MAY VARY FROM STATE TO STATE.

The limited warranty applies to hardware products only.

AST RESEARCH, INC.

Product Comment Form

**SixPakPlus®
User's Manual
000490-001 A**

We appreciate your comments regarding any problems or suggestions related to AST Research products. Please use this form to communicate any observations that you have concerning the improvement of either the product itself or the product documentation provided in this manual.

Submitter Information

Submitter's name:

Address:

Product/Manual Comments and Suggestions

Please mail this form to:

AST Research, Inc.
Attn: Product Marketing
2121 Alton Ave.
Irvine, CA 92714-4992

