

Operating Instructions

Impact Dot Matrix Printer



Panasonic

Before operating this unit, please read these instructions completely.

FOR USE IN U.K.

IMPORTANT:

The wires in the main leads are coloured in accordance with the following code:

Green and yellow:	Earth
Blue:	Neutral
Brown:	Live

As the colours of the wires in the main lead of this apparatus may not correspond with the coloured markings identifying the terminals in your plug, proceed as follows:

- The wire which is coloured green and yellow must be connected to the terminal in the plug which is marked by the letter E or by the safety earth symbol \perp or coloured green or green-and yellow.
- The wire which is coloured blue must be connected to the terminal which is marked with the letter N or coloured black.
- The wire which is coloured brown must be connected to the terminal which is marked with the letter L or coloured red.

WARNING: This apparatus must be earthed.

- This equipment is produced to BS800: 1988.

Any details given in these Operating Instructions are subject to change without notice.

WARNING

- Power source voltage of this unit is listed on the nameplate. Do not fail to plug the printer into an outlet with the proper voltage.
- To prevent fire or shock hazard, do not expose this product to rain or any type of moisture.
- When you operate this equipment, the socket-outlet shall be near the equipment and shall be easily accessible.

The serial number of the unit may be found on the label on the rear of the unit. For your convenience, note this number below, and retain this book, along with your proof of purchase, to serve as a permanent record of your purchase in the event of a theft, or for future reference.

MODEL NO. KX-P1123 NAME OF DEALER _____

SERIAL NO. _____ DATE OF PURCHASE _____

IBM and IBM PC are registered trademarks of International Business Machines Corporation.

Proprinter is a trademark of International Business Machines Corporation.

Microsoft is a registered trademark of Microsoft Corporation.

Apple is a registered trademark of Apple Computer, Inc.

Epson is a registered trademark of Seiko Epson Corporation.

Table of Contents

		Page
1	1. Introduction	
	1.1 Product Overview	1-1
2	1.2 Specifications	1-3
	1.3 Parts of the Printer	1-5
3	2. Set up	
	2.1 Site Requirements	2-1
	2.2 Unpacking and Inspection	2-1
4	2.3 Power up	2-2
	2.4 Mounting the Ribbon Cassette	2-2
	2.5 Paper Feed Selection	2-4
5	2.6 Control levers	2-5
	2.7 Paper Installation	2-6
6	A. Fanfold Paper	2-6
	Rear feeding	2-6
	Bottom feeding	2-10
7	B. Single Sheets and Envelopes (Friction)	2-13
	2.8 Self Test	2-16
8	2.9 Connecting to a Computer	2-17
	3. Operation	
9	3.1 Front Panel Switches	3-1
	3.2 Control Table	3-3
A	A. FONT/PITCH/FORM LENGTH	3-3
	B. ENHANCEMENT	3-5
	C. LEFT / RIGHT MARGIN	3-6
B	D. MACROs	3-7
	E. FACTORY	3-10
	F. QUIET mode	3-11
C	3.3 Feeding the Paper	3-12
	A. Perforation Cut (P.CUT)	3-13
	B. Automatic Paper Loading (LOAD/PARK)	3-14
D	C. Paper Parking (In Rear feeding)	3-14
	D. Top of Form function (TOF SET)	3-16
E	3.4 Initial Setup mode	3-18
	3.5 Detectors	3-25
F	3.6 Initialization	3-26
	3.7 Hex Dump	3-27
G		

Table of Contents

4. Software Introduction	Page	1
4.1 Introduction	4-1	
4.2 Control Codes	4-1	2
4.3 Entering Control Codes through Commercial Software Packages	4-2	
4.4 Entering Control Codes Directly from the Keyboard .	4-4	3
4.5 Entering Control Codes from Within a Basic Program	4-5	
4.6 Entering Hexadecimal Code	4-5	4
4.7 Control Codes	4-5	
4.8 Special Code for IBM PC or Compatible	4-7	5
5. KX-P1123 Features		
5.1 Print Feature Control	5-1	6
5.2 Download Characters	5-3	
5.3 Bit Image (Graphics)	5-14	7
6. Epson LQ-850 Mode Commands	6-1	
7. IBM Proprinter X24 Mode Commands	7-1	8
8. Interfacing	8-1	9
9. Maintenance	9-1	
Appendix A Character Set Chart	A-1	A
Appendix B Proportional Spacing Tables	B-1	B
Appendix C Structure of an Index Table Entry	C-1	C
Appendix D Download Character Matrix Blanks	D-1	D
Appendix E Paper Specifications	E-1	E
Appendix F Printing Area	F-1	F
Appendix G Glossary	G-1	F
Index	Index-1	F
OPTIONS and SUPPLIES	Inside back cover	G

1. Introduction

1 1.1 Product Overview

This printer is a versatile, high quality 24-pin dot matrix printer which is designed to meet the needs of your office.

This printer features the EZ Set Operator Panel that lets you control a wide variety of printing conditions quickly and conveniently from the panel.

The EZ Set Operator Panel allows you to control more than 20 functions including:

- Font selections including 3 Draft and 4 Letter Quality (LQ) fonts
- Pitch selections including 10, 12, 15, 17 characters per inch and PS (Proportional Spacing)
- Form Length selections including 8, 8.5, 11, 11²/₃, 12 and 14 inches
- Enhancements: Bold, Italic, Double height, Double width, Double strike and Centering
- Setting Left and Right margins
- Setting Quiet mode which reduces printing noise
- Write and Read MACROs which store the printing format
- P. CUT which raises the perforation to the tear bar; eliminates paper waste and maximizes print
- Setting Top of Form which stores the top margin according to the paper path used
- And more...

The printer has landscape insertion capability (up to 11.7 inches) and 3 paths; rear, bottom and top.

The KX-P1123 offers burst speeds up to 240 cps (characters per second) in draft mode or 63 cps in LQ (Letter Quality) mode.

The printer is equipped with an internal 6K buffer. An optional 32K buffer is available which expands the total buffer size to 38K. The entire buffer area can be used as a receiving buffer or a portion can be used as a download font area. The buffer area assignment is selected through the EZ Set Operator Panel; Initial Setup Mode.

For software compatibility, this printer has two command sets: Epson LQ-850 and IBM Proprinter X24. Either set can be selected through the EZ Set Operator Panel; Initial Setup Mode.

Introduction

1 1.2 Specifications

Power requirements:	Refer to the nameplate located on the rear of the printer.	
Frequency:		
Current:		
Interface:	Centronics parallel RS-232C / Serial interface board [KX-PS10, KX-P19] (option)	
Print fonts:	3 Draft (Pica, Elite, Micron) 4 Letter Quality (Courier, Prestige, Bold PS, Script)	
Software emulation:	Epson LQ-850 (without shadow & outline), IBM Proprinter X24	
Character sets:	96 ASCII characters 96 Italic ASCII characters 32 International characters—13 countries and LEGAL 32 Italic International characters —13 countries and LEGAL 158 IBM special characters—sets 1 & 2	
Dot configuration:	1/127 inch (0.2 mm)	
Dot diameter	Draft (Pica/Elite/Micron)	LQ
Matrix (Ver. × Hor.)	24 × 9 / 24 × 8 / 24 × 7	24 × 30
Dot pitch (Hor.)	1/120" (0.21 mm)	1/360" (0.07 mm)
(Ver.)	1/180" (0.14 mm)	1/180" (0.14 mm)
Maximum number of characters per line (cpl):	Pica [10 cpi (characters per inch)]	80 cpl
	Elite (12 cpi)	96 cpl
	Micron (15 cpi)	120 cpl
	Compressed (17 cpi)	137 cpl
	Elite compressed (20 cpi)	160 cpl
	Pica elongated (5 cpi)	40 cpl
	Elite elongated (6 cpi)	48 cpl
	Micron elongated (7.5 cpi)	60 cpl
	Compressed elongated (8.5 cpi)	68 cpl
	Elite compressed elongated (10 cpi)	80 cpl
Printing speed [characters per second (cps)]:	Draft	LQ
	Micron	240 cps
	Elite	192 cps
	Pica	160 cps
		53 cps

Printing direction:	User selectable: Bidirectional or Unidirectional
Line feed time:	Approx. 100 msec [with 1/6 inch (4.2 mm) line feeding]
Paper feed:	Pull/Push (user selectable) Tractor feed (with fanfold paper) Friction feed (with single sheet or envelopes)
Paper used:	Fanfold paper: Width: 4~10 inches (102~254 mm) Weight: pull mode: 16~24 lbs (53~90 gms/m ²) push mode: 16~24 lbs (53~90 gms/m ²) Single sheet: Width: 4~11.7 inches (102~297 mm) Height: 5~14.3 inches (127~363 mm) Weight: 14~24 lbs (41~90 gms/m ²) Envelopes: Standard envelopes ie: #6, #10 (Refer to Appendix E)
Copies:	Original + 3 non carbon copies
Paper thickness:	Total thickness of sheets must be less than 0.013 inch (0.32 mm)
Operating environment:	50°F (10°C) to 95°F (35°C) temperature, 30~80% humidity (Please allow the printer to stabilize at room temperature within the operating temperature range before operation)
Storage environment:	- 4 F°(-20°C) to 140°F (60°C) temperature, 10~90% humidity
Head life:	Approximately 100 million characters (200 million strokes) in draft mode
Ribbon:	Cassette seamless fabric ribbon Ink color: Black Yield: Approx. 3 million characters in draft mode (rolling ASCII)
Dimensions:	16.7 (W) × 13.4 (D) × 5.2 (H) in. (423 × 341 × 133 mm)
Weight:	Approx. 15.7 lbs (7.1 kg)

Introduction

1 1.3 Parts of the Printer

Front View

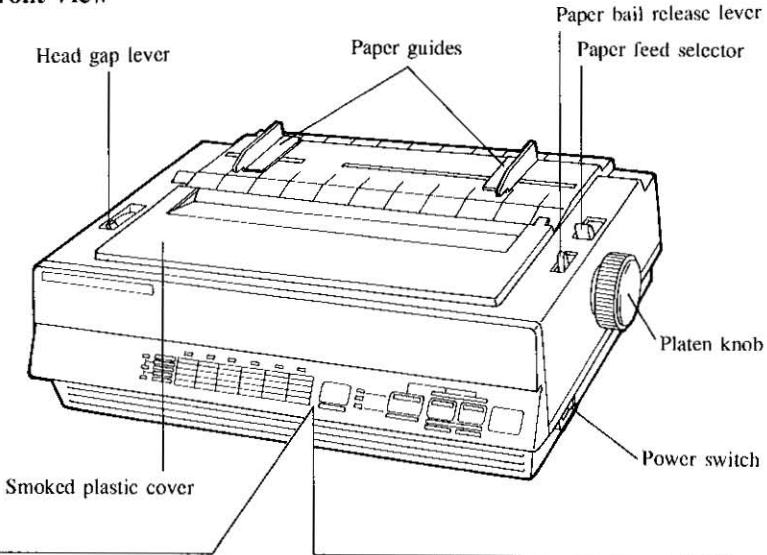

EZ Set Operator Panel

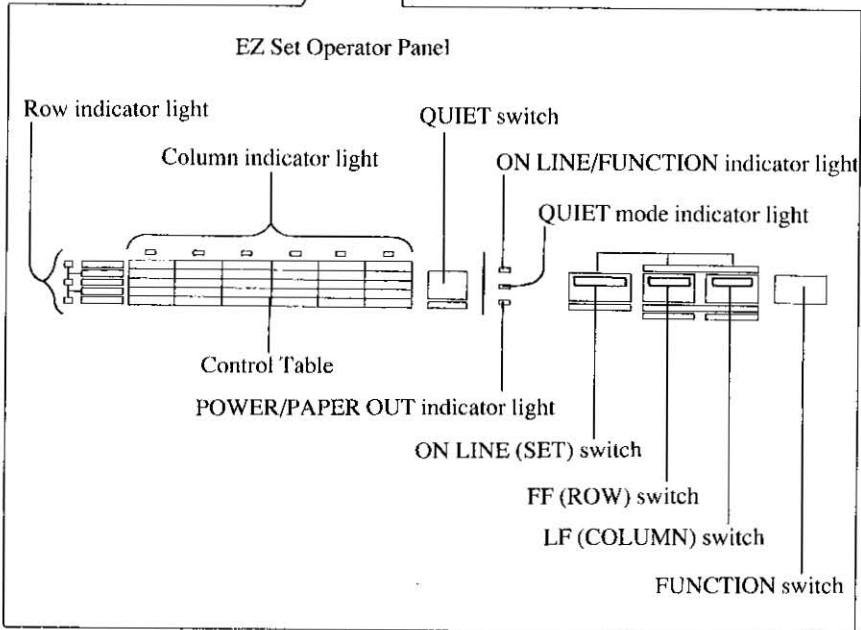

Top View

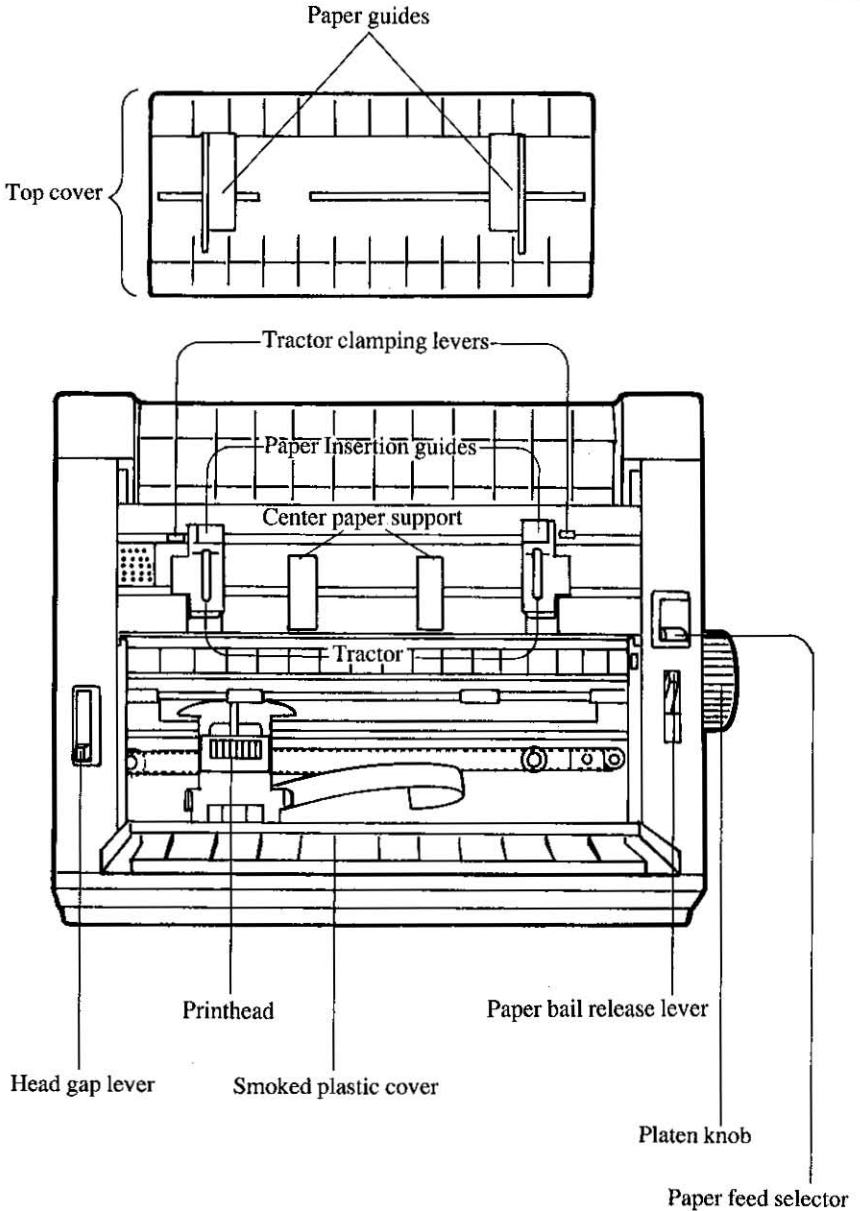

Introduction

1

Rear View

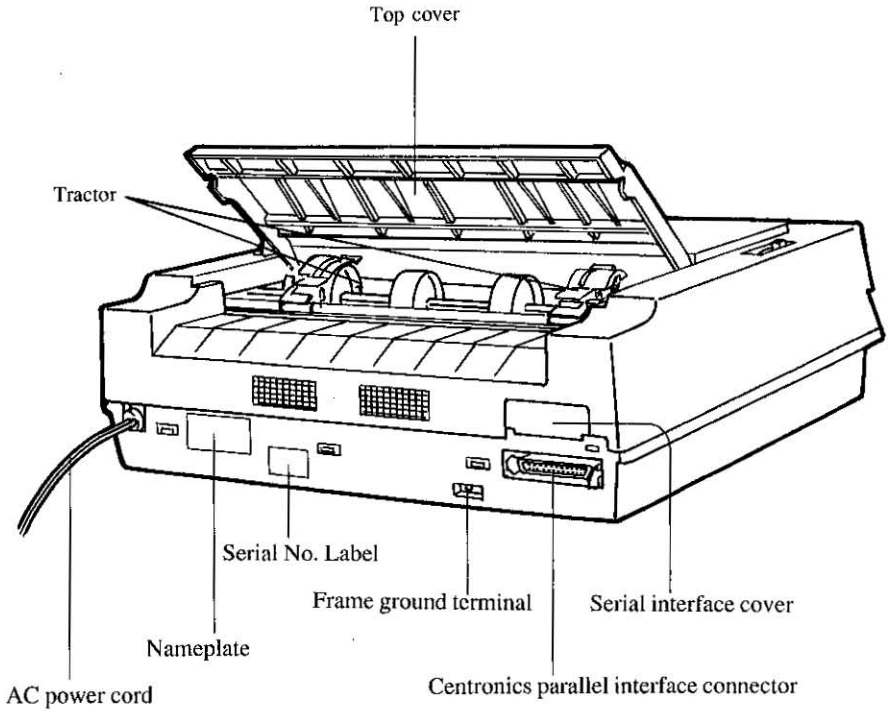

2. Set up

2.1 Site Requirements

This printer can be installed in any normal office environment. No special wiring or cooling is required.

However, do not use the printer under the following conditions:

- extremely high or low temperature [temperature range: 50~95°F (10~35°C)]
- extremely high or low humidity (humidity range: 30~80% RH)
- areas of poor ventilation [a minimum of 4" (10 cm) clearance on all sides necessary to insure proper ventilation]
- areas of high dust concentration
- areas with chemical fume concentration
- areas with extreme vibration or when placed on an unstable or unlevelled surface

2.2 Unpacking and Inspection

Having opened the shipping carton, carefully remove the contents. Inspect the printer and accessories for damage. Report damage or shortages to the store from which the unit was purchased. Inside the manual's front cover record important information regarding the printer.

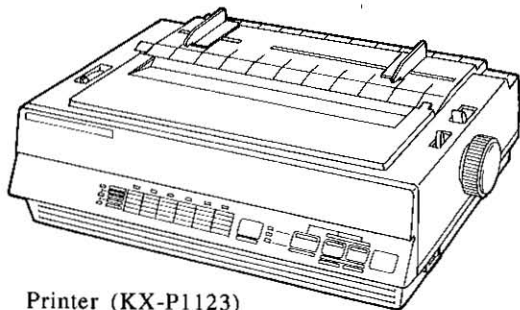

Printer (KX-P1123)

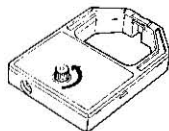

Ink ribbon cassette
(KX-P145)

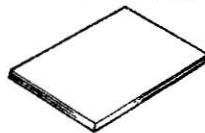

Operating manual

Note:

- **Please keep all the packing materials** so they may be used should you wish to transport the printer in the future. They are specifically designed to protect your printer during shipment.

Set up

2.3 Power Up

2

Plug the power cord into an outlet of the proper rating listed on the nameplate located in the rear of the printer.

The power switch is located on the right side of the printer toward the front. When the power is supplied to the printer, the power indicator light on the front panel will light.

2.4 Mounting the Ribbon Cassette

1. Make sure the printer is off. Open the smoked plastic cover.
2. Gently slide the carriage toward the center of the unit.

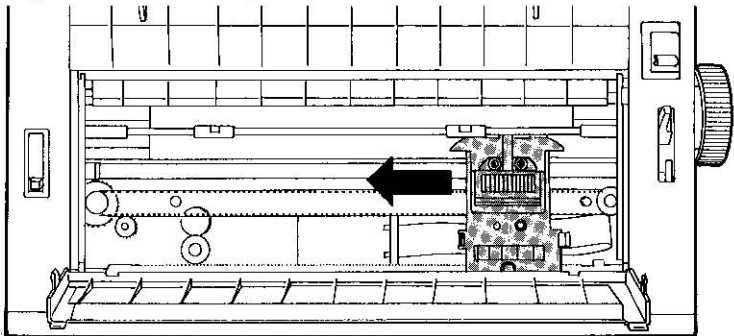

3. Be sure the head gap lever is in the (+) position.
4. Prior to installing the cassette, remove any slack on the ribbon by rotating the knob on the cassette counterclockwise.

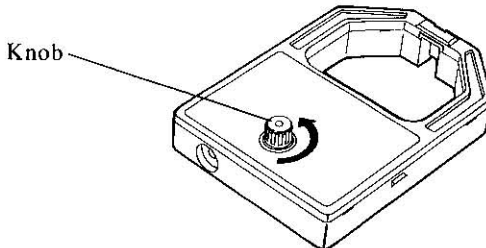

5. Position the cassette over the printhead and lower it in place as shown ①. Visually insure that the ribbon slips between the nose cover and the nose of the printhead. Gently, but firmly, press down on rear of the cassette until the wing tab snap into place ②.

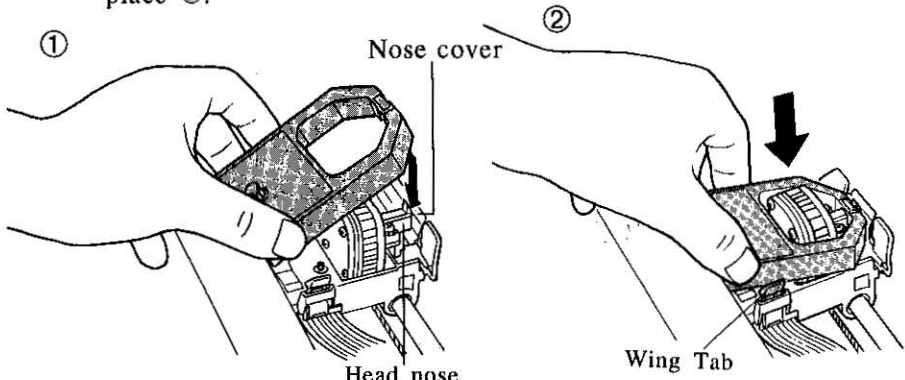

6. Close the smoked plastic cover.

7. Reposition the head gap lever for the appropriate paper thickness.

Note:

• Because the printhead may be extremely hot, use caution when cover is open.

To remove the ribbon cassette, spread the wing tab and lift up the cassette.

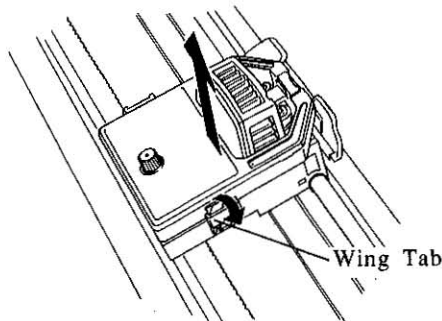

2.5 Paper Feed Selection

2

This printer has two paper feed mechanisms (Tractor and Friction) and 3 paper paths. You can select the best method for your paper type and printing needs. Refer to the table below.

PAPER MODE	PATH	BEST USED WHEN/FOR
Tractor	Rear (Push)	-doing any type of reverse paper feeding -enabling you to do Paper Parking -using single form continuously fed paper
	Bottom (Pull)	-multipart forms (see Note) -labels
Friction	Top	-single sheet -envelope

T. Park

Note:

- When feeding paper from the bottom, **do not** reverse line feed. Paper may not feed correctly and print quality may not be optimum.
- Paper Parking is not available when the paper is installed from the bottom.
- Single sheets or envelopes can be fed through the top individually or using the KX-P37 Cut Sheet Feeder.
- When using multipart forms: when rear feeding (push mode) only use up to 2 part forms. For 3 or 4 part forms, we recommend bottom feeding (pull mode) for optimum print quality.

2.6 Print Control Levers

Paper feed selector

This selector should be set for the paper method you wish to use to print.

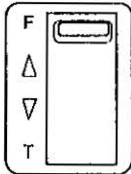

POSITION	USE FOR
T (Tractor)	Fanfold paper
F (Friction)	Single sheet and Envelopes

Paper bail release lever

This lever sets the paper bail position and loads/parks the paper automatically.

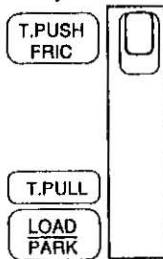

POSITION	USE FOR
T.PUSH/FRIC	Rear/Top feeding Paper bail presses the paper
T.PULL	Bottom feeding Paper bail releases the paper
LOAD/PARK	Load the paper automatically Parks rear-fed paper

Head gap lever

This lever adjusts the gap between the printhead and the platen to compensate for the thickness of the paper.

The lever has 6 steps and moves the printhead closer to or farther away from the platen approximately 0.0028 inch (0.07 mm) per step.

To move the lever forward (-) narrows the gap.

To move the lever backward (+) widens the gap.



POSITION	USE FOR
1 or 2	Thinner sheets
3, 4, 5, and 6	Thick or multiple sheets envelopes

Note:

- If an ink smear occurs when loading paper or during printing, move the lever toward the lower position (+) until the smear no longer appears.

2.7 Paper Installation

2

A. Fanfold Paper

To install Fanfold paper follow these procedures.

Rear Feeding

1. Turn the power switch on. A beep will sound once and the paper out indicator will flash. This indicates that there is no paper installed in the printer.
2. Verify that the head gap lever is in the (+) position.
3. Set the paper feed selector to the "T" position.

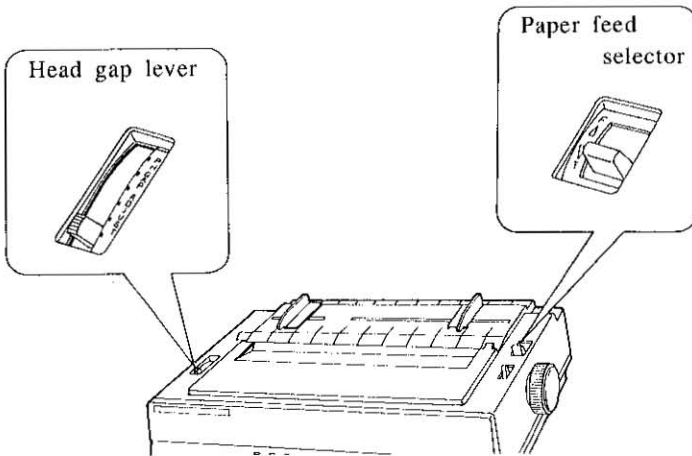

4. Remove the top cover as shown below. Lift to most upright position, then slightly lower and pull back.

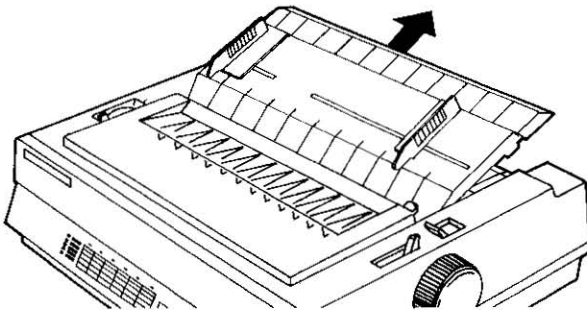

5. Unlock the tractors by pulling the tractor clamping levers forward. Slide the tractors out toward the sides to the approximate width of the paper.

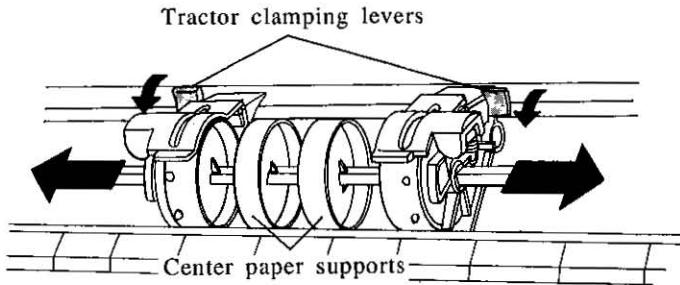

6. Space the center paper support evenly between the tractors.

7. Open both tractor covers.

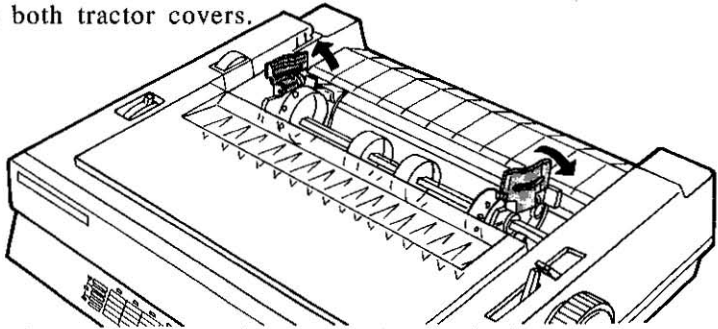

8. Align the paper so that the tractor pins catch the paper sprocket holes.

9. Close the tractor covers.

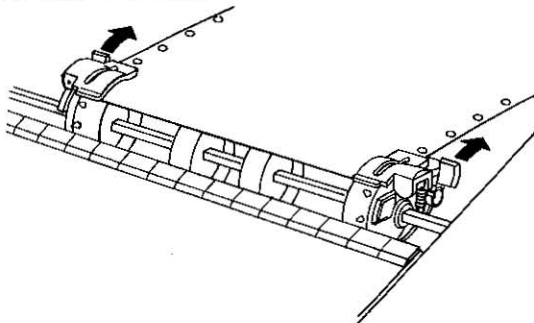

Set up

2

10. Pull the tractors outward to remove any slack, then lock the tractors into position by pushing the tractor clamping levers back.
11. Open the tractor covers and remove the paper, then close the tractor covers.
12. Press the FF switch **while** pressing the ON LINE switch. The tractor will rotate automatically for ten seconds.
13. While the tractor is rotating, insert the fanfold paper behind the pinwheel evenly, between the paper insertion guides, until the tractor pins catch the paper sprocket holes.
—Verify the paper is installed straight. If jamming occurs, remove the paper by rotating the platen knob back.

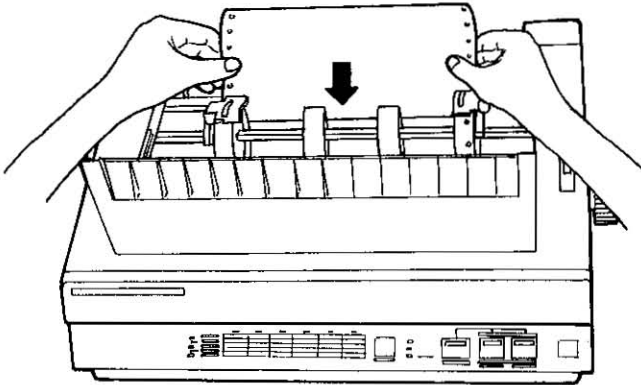

14. Pull the paper bail release lever to the "LOAD/PARK" position, the printer will load the paper automatically to the first print line. Verify the paper is straight.
15. Push the paper bail release lever to "T.PUSH/FRIC." position.
16. Set the head gap lever to the appropriate thickness of the paper being used. Refer to Section 2.6 on page 2-5.

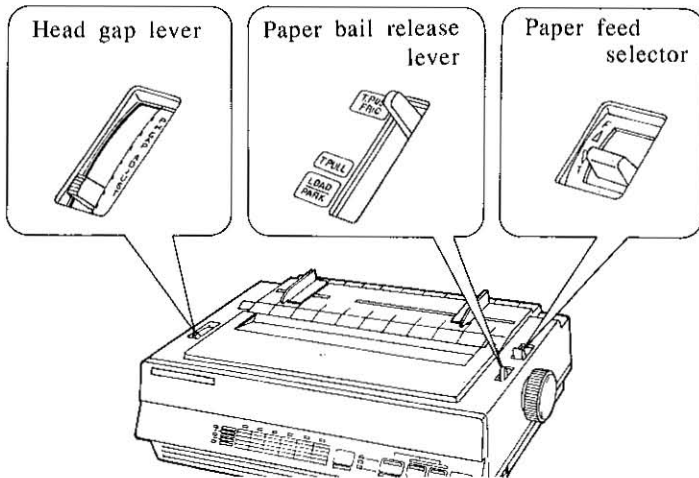

17. Replace the top cover.

Note:

- You can now adjust your Top of Form position (see page 3-16) or press the ON LINE switch to get ready to print.

Positioning Fanfold paper:

When using fanfold paper with the built-in tractor in the push mode, it is important to have the exiting paper flow over the top cover of the printer.

Note:

- When using fanfold paper and a paper jam occurs flip lever from T.PULL to T.PUSH and pull jammed paper out through rear. This procedure will eliminate paper debris getting lodged underneath pinwheel tractor mechanism.

Set up

Bottom Feeding

2

1. Turn the power switch on. A beep will sound once and the paper out indicator will flash. This indicates that there is no paper installed in the printer.
2. Verify that the head gap lever is in the (+) position.
3. Set the paper bail release lever to "T.PULL" position.
4. Set the paper feed selector to the "T" position.

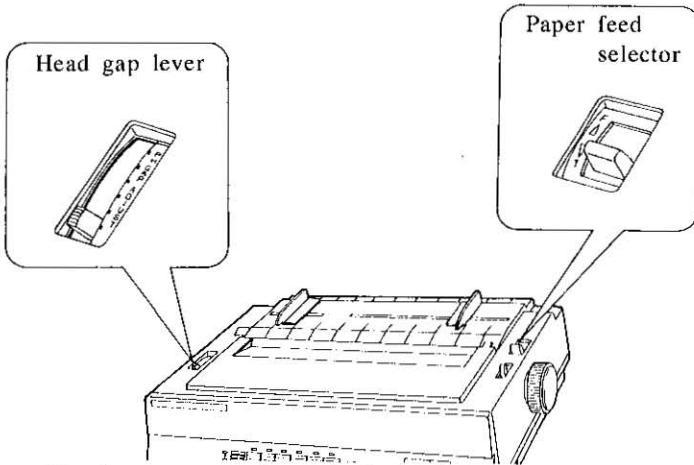

5. Open the top cover and smoked plastic cover.
6. Unlock the tractors by pulling the tractor clamping levers forward. Slide the tractors out toward the sides to the approximate width of the paper.

Tractor clamping levers

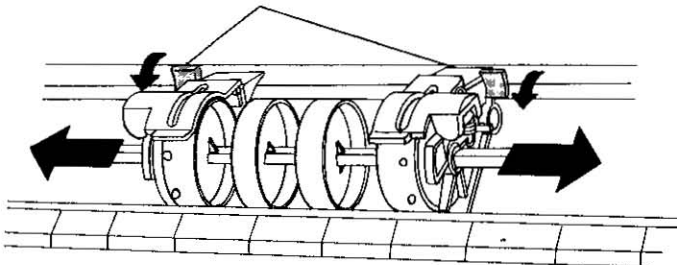

7. Space the center paper supports evenly between the tractors.
8. Open both tractor covers.

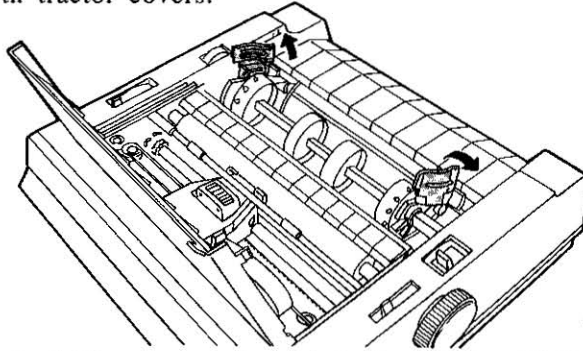

9. Push the fanfold paper up through bottom slot until it appears on the platen. Make sure the side on which you wish to print is facing you.
10. Pull the paper up until it reaches the tractor pins. Then, align the paper so that the tractor pins catch the paper sprocket holes.

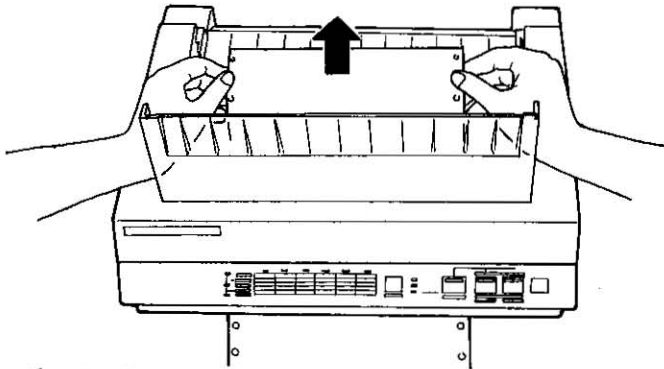

11. Close the tractor covers.

Set up

2

12. Pull the tractors outward to remove any slack, then lock the tractors into position by pushing the tractor clamping levers back.

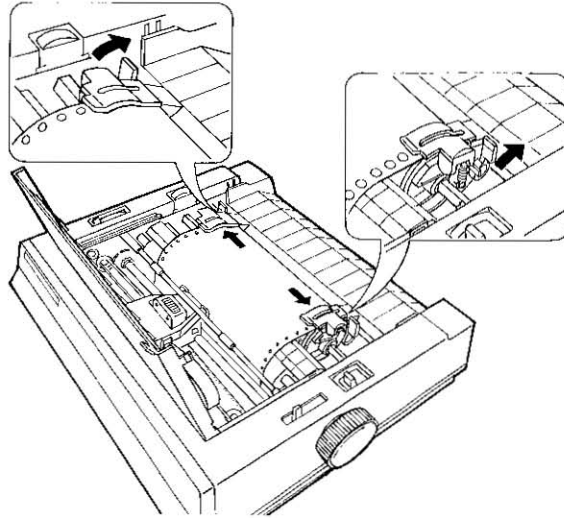

13. Set the head gap lever to the appropriate thickness of the paper being used. Refer to Section 2.6 on page 2-5.

14. Replace the top cover and smoked plastic cover.

Note:

- You can now adjust your Top of Form position (see page 3-16, item #3) or press the ON LINE switch to get ready to print.
- When bottom feeding, reverse feed functions may effect accurate line feeding and printer will not feed paper correctly and the print quality may not be as desired.

B. Single Sheets and Envelopes (Friction)

To install a single sheet of paper or an envelope, follow these procedures.

2

1. Turn the power switch on. A beep will sound and the paper out indicator will flash. This indicates that there is no paper installed in the printer.
2. Verify that the head gap lever is in the (+) position.
3. Verify that the paper feed selector is in the "F" position.

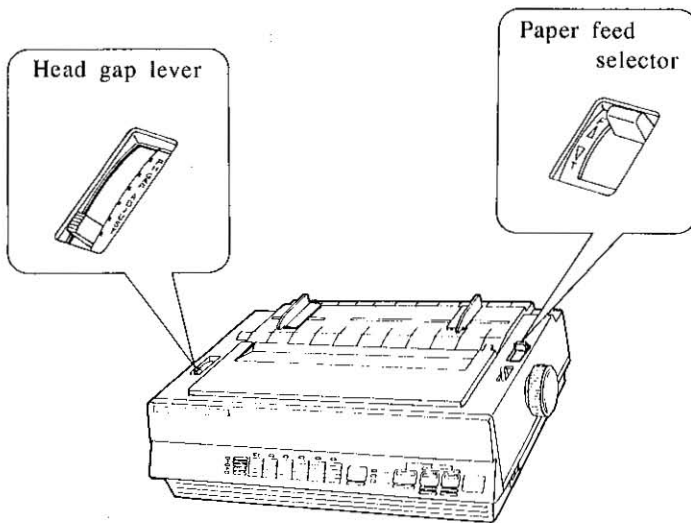

4. Raise the top cover.

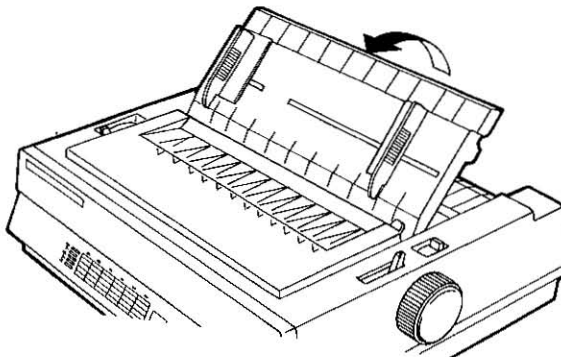

Set up

2

5. Insert the paper through the paper guides and behind the platen. Set the paper guides to the approximate width of your paper.

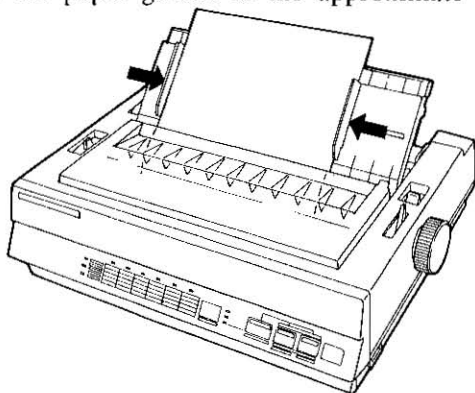

6. Pull the paper bail release lever to the "LOAD/PARK" position then release. This will load the paper automatically.
7. To align the paper horizontally or vertically, set the paper feed selector to the "T" position. This releases the paper and allows the paper to be positioned manually as required. Set the selector back to "F" before printing.

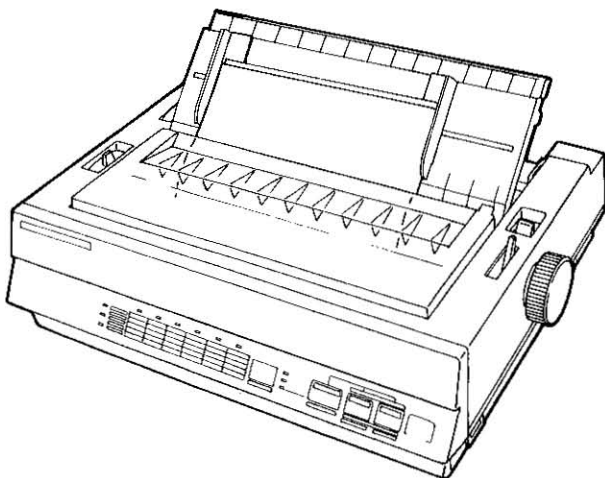

8. Set the head gap lever to the appropriate thickness of the paper being used. Refer to Section 2.6 on page 2-5.
9. Reposition the paper bail release lever to the "T.PUSH/FRIC" position.

Note:

- You can now adjust your Top of Form position (see page 3-16, item #3) or press the ON LINE switch to get ready to print.
- When the paper feed selector is in the "T" position, the buzzer will sound to inform you that the selector is in the wrong position.
- When loading an envelope, if the envelope will not load smoothly, switch the paper feed selector to the "T" position and insert the envelope manually, then move the selector back to the "F" position. After the above process, pull the paper bail release lever to the "LOAD/PARK" position, then release.

Set up

2.8 Self Test

2

The printer has a self test feature which allows the user to test the printer. The mode is entered by turning on the power switch while pressing the LF switch.

First, all ASCII characters will be printed in draft and all four LQ fonts in 10 cpi. Then they will be printed in draft mode for approximately 20 minutes. To release the self test mode, turn the power switch off.

```
Version
Draft
!"#%&'()*+,-./0123456789:;<=?@ABCDEFGHIJKLMNopqrstuvwxyz[\]^_`abdefghi jklmno
!"#%&'()*+,-./0123456789:;<=?@ABCDEFGHIJKLMNopqrstuvwxyz[\]^_`abdefghi jklmnopq
!"#%&'()*+,-./0123456789:;<=?@ABCDEFGHIJKLMNopqrstuvwxyz[\]^_`abdefghi jklmnopq
!"#%&'()*+,-./0123456789:;<=?@ABCDEFGHIJKLMNopqrstuvwxyz[\]^_`abdefghi jklmnopqrs
!"#%&'()*+,-./0123456789:;<=?@ABCDEFGHIJKLMNopqrstuvwxyz[\]^_`abdefghi jklmnopqrst
!"#%&'()*+,-./0123456789:;<=?@ABCDEFGHIJKLMNopqrstuvwxyz[\]^_`abdefghi jklmnopqrstuv
Courier
!"#%&'()*+,-./0123456789:;<=?@ABCDEFGHIJKLMNopqrstuvwxyz[\]^_`abdefghi jklmno
!"#%&'()*+,-./0123456789:;<=?@ABCDEFGHIJKLMNopqrstuvwxyz[\]^_`abdefghi jklmnop
!"#%&'()*+,-./0123456789:;<=?@ABCDEFGHIJKLMNopqrstuvwxyz[\]^_`abdefghi jklmnopq
!"#%&'()*+,-./0123456789:;<=?@ABCDEFGHIJKLMNopqrstuvwxyz[\]^_`abdefghi jklmnopqr
!"#%&'()*+,-./0123456789:;<=?@ABCDEFGHIJKLMNopqrstuvwxyz[\]^_`abdefghi jklmnopqrs
!"#%&'()*+,-./0123456789:;<=?@ABCDEFGHIJKLMNopqrstuvwxyz[\]^_`abdefghi jklmnopqrst
!"#%&'()*+,-./0123456789:;<=?@ABCDEFGHIJKLMNopqrstuvwxyz[\]^_`abdefghi jklmnopqrstu
!"#%&'()*+,-./0123456789:;<=?@ABCDEFGHIJKLMNopqrstuvwxyz[\]^_`abdefghi jklmnopqrstuv
Prentice
!"#%&'()*+,-./0123456789:;<=?@ABCDEFGHIJKLMNopqrstuvwxyz[\]^_`abdefghi jklmno
!"#%&'()*+,-./0123456789:;<=?@ABCDEFGHIJKLMNopqrstuvwxyz[\]^_`abdefghi jklmnop
!"#%&'()*+,-./0123456789:;<=?@ABCDEFGHIJKLMNopqrstuvwxyz[\]^_`abdefghi jklmnopq
!"#%&'()*+,-./0123456789:;<=?@ABCDEFGHIJKLMNopqrstuvwxyz[\]^_`abdefghi jklmnopqr
!"#%&'()*+,-./0123456789:;<=?@ABCDEFGHIJKLMNopqrstuvwxyz[\]^_`abdefghi jklmnopqrs
!"#%&'()*+,-./0123456789:;<=?@ABCDEFGHIJKLMNopqrstuvwxyz[\]^_`abdefghi jklmnopqrst
!"#%&'()*+,-./0123456789:;<=?@ABCDEFGHIJKLMNopqrstuvwxyz[\]^_`abdefghi jklmnopqrstu
!"#%&'()*+,-./0123456789:;<=?@ABCDEFGHIJKLMNopqrstuvwxyz[\]^_`abdefghi jklmnopqrstuv
Bold PS
!"#%&'()*+,-./0123456789:;<=?@ABCDEFGHIJKLMNopqrstuvwxyz[\]^_`abdefghi jklmno
!"#%&'()*+,-./0123456789:;<=?@ABCDEFGHIJKLMNopqrstuvwxyz[\]^_`abdefghi jklmnop
!"#%&'()*+,-./0123456789:;<=?@ABCDEFGHIJKLMNopqrstuvwxyz[\]^_`abdefghi jklmnopq
!"#%&'()*+,-./0123456789:;<=?@ABCDEFGHIJKLMNopqrstuvwxyz[\]^_`abdefghi jklmnopqr
!"#%&'()*+,-./0123456789:;<=?@ABCDEFGHIJKLMNopqrstuvwxyz[\]^_`abdefghi jklmnopqrs
!"#%&'()*+,-./0123456789:;<=?@ABCDEFGHIJKLMNopqrstuvwxyz[\]^_`abdefghi jklmnopqrst
!"#%&'()*+,-./0123456789:;<=?@ABCDEFGHIJKLMNopqrstuvwxyz[\]^_`abdefghi jklmnopqrstu
!"#%&'()*+,-./0123456789:;<=?@ABCDEFGHIJKLMNopqrstuvwxyz[\]^_`abdefghi jklmnopqrstuv
Script
!"#%&'()*+,-./0123456789:;<=?@ABCDEFGHIJKLMNopqrstuvwxyz[\]^_`abdefghi jhlmno
!"#%&'()*+,-./0123456789:;<=?@ABCDEFGHIJKLMNopqrstuvwxyz[\]^_`abcde6ghi jhlmnop
!"#%&'()*+,-./0123456789:;<=?@ABCDEFGHIJKLMNopqrstuvwxyz[\]^_`abdefghijhlmnopq
!"#%&'()*+,-./0123456789:;<=?@ABCDEFGHIJKLMNopqrstuvwxyz[\]^_`abdefghijhlmnopqr
!"#%&'()*+,-./0123456789:;<=?@ABCDEFGHIJKLMNopqrstuvwxyz[\]^_`abdefghijhlmnopqrs
!"#%&'()*+,-./0123456789:;<=?@ABCDEFGHIJKLMNopqrstuvwxyz[\]^_`abdefghijhlmnopqrst
!"#%&'()*+,-./0123456789:;<=?@ABCDEFGHIJKLMNopqrstuvwxyz[\]^_`abdefghijhlmnopqrstu
!"#%&'()*+,-./0123456789:;<=?@ABCDEFGHIJKLMNopqrstuvwxyz[\]^_`abdefghijhlmnopqrstuv
!"#%&'()*+,-./0123456789:;<=?@ABCDEFGHIJKLMNopqrstuvwxyz[\]^_`abdefghi jklmno
!"#%&'()*+,-./0123456789:;<=?@ABCDEFGHIJKLMNopqrstuvwxyz[\]^_`abdefghi jklmnop
!"#%&'()*+,-./0123456789:;<=?@ABCDEFGHIJKLMNopqrstuvwxyz[\]^_`abdefghi jklmnopq
!"#%&'()*+,-./0123456789:;<=?@ABCDEFGHIJKLMNopqrstuvwxyz[\]^_`abdefghi jklmnopqr
!"#%&'()*+,-./0123456789:;<=?@ABCDEFGHIJKLMNopqrstuvwxyz[\]^_`abdefghi jklmnopqrs
!"#%&'()*+,-./0123456789:;<=?@ABCDEFGHIJKLMNopqrstuvwxyz[\]^_`abdefghi jklmnopqrst
!"#%&'()*+,-./0123456789:;<=?@ABCDEFGHIJKLMNopqrstuvwxyz[\]^_`abdefghi jklmnopqrstu
!"#%&'()*+,-./0123456789:;<=?@ABCDEFGHIJKLMNopqrstuvwxyz[\]^_`abdefghi jklmnopqrstu
!"#%&'()*+,-./0123456789:;<=?@ABCDEFGHIJKLMNopqrstuvwxyz[\]^_`abdefghi jklmnopqrstu
```

2.9 Connecting to a Computer

The computer communicates with the printer through an interface cable which you must purchase separately. The printer comes with a Centronics parallel interface.

1. Be sure the power switches of both the printer and the computer are turned off.
2. Plug one end of the cable into the connector of the printer and snap the clips into place.

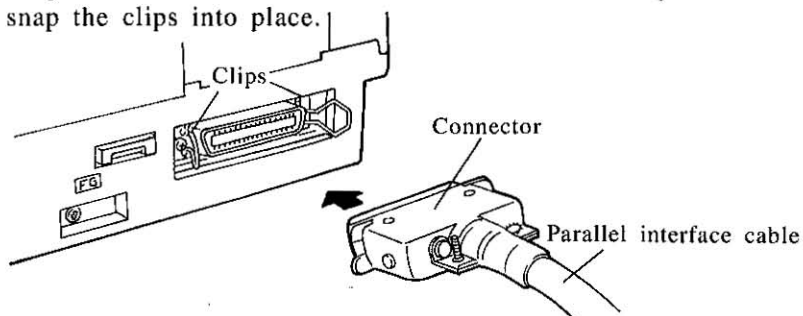

If the cable has a frame ground wire, connect it to the frame ground terminal.

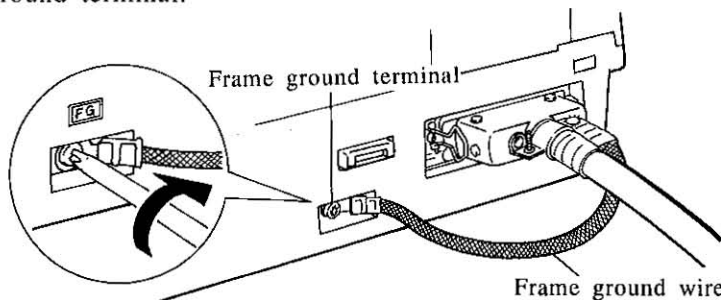

3. Plug the other end of the cable into the connector of the computer.

Note:

- If the connectors are not alike make sure to plug the appropriate end into each device.
- A RS-232C serial interface is available as an option.
- See Section 8 "Interfacing" for detailed information.

3. Operation

3.1 Front Panel Switches

This printer has an EZ Set Operator Panel with five switches and a Control Table. These switches allow you to select various features and functions of the printer.

3



FUNCTION switch

This switch allow you to enter and exit the FUNCTION mode. The FUNCTION mode allows you to operate the Control Table, P.Cut and Top of Form. When activated the ON LINE indicator will blink.

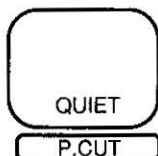

QUIET switch

In the OFF LINE mode or when the printer is not printing in the ON LINE mode, this switch turns the QUIET mode on (QUIET indicator is lit), which reduces printing noise, or off (QUIET indicator is not lit), returns printing noise level to normal mode. Refer to page 3-15.

In the FUNCTION mode, this switch will advance or reverse the paper for perforation cut (P.CUT). Refer to page 3-13.

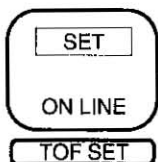

ON LINE / SET switch

This switch opens and closes the communications line with the computer. When open, the ON LINE indicator is lit and allows information to be sent from the computer to the printer. When closed or OFF LINE, the ON LINE indicator will not be lit and does not allow information to be sent to the printer.

In the FUNCTION mode, this switch has two functions:

- 1) It will activate the selections chosen on the Control Table. Refer to section 3.2.
- 2) It will set the Top of Form. Refer to page 3-16.

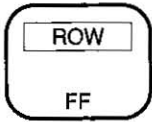

FF / ROW switch

This switch advances the paper to the next top of form. This switch is active in the OFF LINE mode or when the printer is not printing in the ON LINE mode.

In the **FUNCTION mode**, this switch will act as the ROW switch and advances the row position on the Control Table. The combination of row lights lit indicates the current feature.

3

Selects type	ROW indicator	Selects type	ROW indicator
FONT	R1 <input checked="" type="checkbox"/>	ENHANCE- MENT	R1 <input type="checkbox"/>
	R2 <input type="checkbox"/>		R2 <input checked="" type="checkbox"/>
	R3 <input type="checkbox"/>		R3 <input checked="" type="checkbox"/>
PITCH	R1 <input checked="" type="checkbox"/>	OTHERS	R1 <input type="checkbox"/>
	R2 <input checked="" type="checkbox"/>		R2 <input type="checkbox"/>
	R3 <input type="checkbox"/>		R3 <input checked="" type="checkbox"/>
FORM LENGTH	R1 <input type="checkbox"/>	STATUS PRINT	R1 <input checked="" type="checkbox"/>
	R2 <input checked="" type="checkbox"/>		R2 <input checked="" type="checkbox"/>
	R3 <input type="checkbox"/>		R3 <input checked="" type="checkbox"/>

=light on =light off



LF / COLUMN switch

In the OFF LINE mode or when the printer is not printing in the ON LINE mode, this switch advances the paper one line at a time.

In the **FUNCTION mode**, this switch will act as the COLUMN switch and advance the column position.

- A lit indicator shows the current setting position.
- A blinking indicator shows that that position is not selected.
- When C1 (first column) indicator is on (lit) for Font or Pitch row the printer is in the PROGRAM mode, this allows software to determine the font/pitch used.

3.2 Control Table

The setting of the Control Table is used to make temporary changes in font, pitch, form length, etc. To permanently store any of these combinations refer to MACROs, page 3-7.

Before changing any settings on the Control table, you should verify the current settings. (Refer to the page 3-9)

A. FONT/PITCH/FORM LENGTH

1. Press the **FUNCTION** switch to enter the FUNCTION mode. The ON LINE/FUNCTION indicator should blink.
2. Press and release the **ROW** switch until the desired feature is indicated. (ie:Font, Pitch or Form length.) (Refer to the page 3-2 for proper sequence.)
3. After selecting the row position, press and release the **COLUMN** switch until the COLUMN indicator is blinking over the desired setting.
4. Press the **SET** switch to store that setting into the temporary memory. A beep will sound. The indicator is on steady. Repeat steps 2 to 4 for each ROW as desired.
5. Press the **FUNCTION** switch to exit the FUNCTION mode.

EXAMPLES

FONT: SCRIPT

		C1	C2	C3	C4	C5	C6
R1	FONT	PROGRAM	DRAFT	COURIER	PRESTIGE	BOLD PS	SCRIPT
R2	PITCH	PROGRAM	10	12	15	17	PS
	FORMLENGTH	11"	12"	14"	8"	8.5"	11.5"
R3	ENHANCEMENT	BOLD	ITALIC	DOUBLE HEIGHT	DOUBLE WIDTH	DOUBLE STRIKE	CENTERING
	OTHERS	LEFT MARGIN	RIGHT MARGIN	MACRO#1	MACRO#2	MACRO#3	FACTORY

PITCH: 12

		C1	C2	C3	C4	C5	C6
R1	FONT	PROGRAM	DRAFT	COURIER	PRESTIGE	BOLD PS	SCRIPT
R2	PITCH	PROGRAM	10	12	15	17	PS
	FORMLENGTH	11"	12"	14"	8"	8.5"	11.5"
R3	ENHANCEMENT	BOLD	ITALIC	DOUBLE HEIGHT	DOUBLE WIDTH	DOUBLE STRIKE	CENTERING
	OTHERS	LEFT MARGIN	RIGHT MARGIN	MACRO#1	MACRO#2	MACRO#3	FACTORY

FORM LENGTH: 11

		C1	C2	C3	C4	C5	C6
R1	FONT	PROGRAM	DRAFT	COURIER	PRESTIGE	BOLD PS	SCRIPT
R2	PITCH	PROGRAM	10	12	15	17	PS
	FORMLENGTH	11"	12"	14"	8"	8.5"	11.5"
R3	ENHANCEMENT	BOLD	ITALIC	DOUBLE HEIGHT	DOUBLE WIDTH	DOUBLE STRIKE	CENTERING
	OTHERS	LEFT MARGIN	RIGHT MARGIN	MACRO#1	MACRO#2	MACRO#3	FACTORY

Note:

- When all 3 row indicators are lit and the **SET** switch is pressed, the current setting and all 3 MACRO settings will be printed out.
- When C1 (first column) indicator is on, the printer is in PROGRAM mode which allows software to determine which Font and/or Pitch will be used.
- The DRAFT in FONT and PS in PITCH can not be set simultaneously. The second entry will be ignored and two beep will sound.
- When FONT is set to Draft, and PITCH to PROGRAM via the EZ Set Operator Panel, and the software issues a Proportional Spacing (PS) command, the printer will execute 10 cpi (Pica) instead of PS.
- When PITCH is set to PS and FONT is set to PROGRAM through the EZ Set Operator Panel, if the default font is Draft, output will be printed in Courier PS.
- If the default is an LQ font, output will be printed in that font. If the printer is in an LQ font mode when a Draft command is issued, the command will be ignored and output will be printed in that LQ font.
- The setting of Form Length also can be changed through software commands, overriding the Control Table settings. Changes through software commands will not be reflected in the Control Table indicators.

B. ENHANCEMENT

The EZ Set Operator Panel allows you to enhance the characters as follows; Bold, Italic, Double Height, Double Width, Double Strike and Centering.

These enhancements are independent and are set individually, therefore, any enhancement can be set with another.

The SET switch alternates between on and off. The indicator will inform you as to the setting. A lit indicator means the enhancement is ON, while a blinking indicator means the setting is OFF.

1. Verify the ON LINE/FUNCTION indicator is blinking. (If not, press the **FUNCTION** switch to enter the FUNCTION mode.)
2. Press and release the **ROW** switch until the ENHANCEMENT row is indicated. (Refer to page 3-2 for row indicator positions.)
3. Press and release the **COLUMN** switch until the COLUMN indicator is lit over the desired enhancement.
4. Press the **SET** switch until the COLUMN indicator is lit.
5. Press the **FUNCTION** switch to exit the FUNCTION mode.

Note:

- When you set Double Height and Double Strike simultaneously, the Double Strike is ignored.
- Bold, Italic, Double Height/Width/Strike are changeable through software commands only when each function is off.
- When you set Double Height, the current line feed is doubled (ie: before Double Height is selected line feed = 1/6 [default] after selection line feed = 1/3). Line feed is selected through software commands.

C. LEFT / RIGHT MARGIN

1. Verify that the ON LINE/FUNCTION indicator is blinking. (If not, press the **FUNCTION** switch to enter the FUNCTION mode.)
2. Press and release the **ROW** switch until the OTHERS row is indicated. See page 3-2 for proper light sequence.
3. Press and release the **COLUMN** switch until the COLUMN indicator is blinking over the desired margin to be set.
4. Press the **SET** switch to enter the MARGIN SET mode, the COLUMN indicator will be lit.
5. Press the **ROW** switch to move the printhead to the left or **COLUMN** switch to move the printhead to the right until you reach the desired margin location.
 - When pressing the **ROW** switch when the printhead is at the far left location; a beep will sound a few times and the printhead will move to the far right location.
 - When pressing the **COLUMN** switch when the printhead is at the far right location; a beep will sound a few times and the printhead will move to the far left location.
6. Press the **SET** switch to specify the margin location. A beep will sound once and exit the MARGIN SET mode, the COLUMN indicator will return to the blinking condition.
 - If the left margin is set to the right of the right margin, the right margin is reset to 80 (10 cpi) automatically.
 - If the right margin is set to the left of the left margin, the left margin is reset to 0 automatically.
7. Press the **FUNCTION** switch to exit the FUNCTION mode.

Note:

- You can set either the left or the right margin first.
- You can change the margins by software commands. This will override the Control Table settings.

D. MACROs

A MACRO allows you to store a combination of your most frequently used Font, Pitch, Form Length, Enhancement, Left/Right Margin and Quiet mode settings into the printer's memory which can be easily recalled and/or changed. This will enable you to recall one of three combinations (MACROs #1, #2, #3) at the touch of a button eliminating the need to reset all your features each time you have a print job that uses a previously set combination.

When you turn the power switch on, the printer reads MACRO#1 automatically. Therefore, it is recommended to store the format you use most often in MACRO#1.

To Define MACRO (MACRO WRITE)

1. Verify that the ON LINE/FUNCTION indicator is blinking. (If not, press the **FUNCTION** switch to enter the FUNCTION mode.)
2. Set the print features you wish to store (FONT, PITCH, FORM LENGTH, ENHANCEMENT, LEFT and RIGHT MARGIN) as the current settings.
(Refer to page 3-3, 3-5, 3-6)
3. If you wish to change your QUIET mode setting, press the **FUNCTION** switch to exit the FUNCTION mode. Set the QUIET mode by pressing the **QUIET** switch. Then, press the **FUNCTION** switch again to return to the FUNCTION mode (ON LINE/FUNCTION indicator is blinking).
4. Press and release the **ROW** switch until the OTHERS row is indicated. See page 3-2 for proper light sequence.
5. Press and release the **COLUMN** switch to reach the indicator over MACRO#1, 2 or 3.
6. Press the **SET** switch to enter the MACRO mode. A beep will sound.
7. Press the **COLUMN** switch to write the current setting data to the MACRO. A beep will sound twice.

8. Press the **SET** switch to store them into the printer's memory and exit MACRO mode. A beep will sound once.
—This setting is maintained in the printer's memory when the power switch is turned off or even if the AC cord is unplugged.
9. Press the **FUNCTION** switch to exit FUNCTION mode.

To Recall a Defined MACRO (MACRO READ)

1. Verify that the ON LINE/FUNCTION indicator is blinking. (If not, press the **FUNCTION** switch to enter the FUNCTION mode.)
2. Press and release the **ROW** switch until the OTHERS row is indicated. See page 3-2 for proper light sequence.
3. Select the MACRO position you desire by pressing and releasing the **COLUMN** switch to reach the indicator over MACRO# 1, 2, or 3.
4. Press the **SET** switch to enter MACRO mode. A beep will sound.
5. Press the **ROW** switch to read the previously defined MACRO. A beep will sound.
6. Press the **SET** switch to recall the MACRO as the current setting and exit the MACRO mode. A beep will sound.
7. Press the **FUNCTION** switch to exit FUNCTION mode.

Note:

• When you turn the power switch on, the printer reads MACRO#1 automatically.

Operation

To Print Out the Current Setting and MACROs Status

3

1. Verify that paper is installed and the ON LINE indicator is blinking. (If not, press the **FUNCTION** switch to enter the FUNCTION mode.)
2. Press and release the **ROW** switch until all ROW indicators are lit.
—When the ROW indicator is on the OTHERS row press the ROW switch once, all row indicators will be lit.
3. Press the **SET** switch to print out the current setting and MACROs settings.
4. Press the **FUNCTION** switch to exit the FUNCTION mode.

E. FACTORY Setting (Defaults Setting)

This is for recalling the settings for: Font, Pitch, Form Length, Enhancement, Left and Right Margin, and Quiet mode as they were originally set when the printer was shipped. However, it does not change any of the settings which are stored in MACRO# 1, 2 or 3. You can recall the FACTORY setting anytime. The FACTORY setting may only be called, you cannot write to (change) the FACTORY as you can a MACRO.

1. Verify that the ON LINE/FUNCTION indicator is blinking. (If not, press the **FUNCTION** switch to enter the FUNCTION mode.)
2. Press and release the **ROW** switch until the OTHERS row is indicated. See page 3-2 for proper light sequence.
3. Press and release the **COLUMN** switch until the column indicator is blinking over the FACTORY position.
4. Press the **SET** switch to enter the FACTORY mode. A beep will sound.
5. Press the **ROW** switch to read the FACTORY settings. A beep will sound.
6. Press the **SET** switch to recall them as the current settings and exit the FACTORY mode. A beep will sound.
7. Press the **FUNCTION** switch to exit the FUNCTION mode.

Note:

- After recalling the FACTORY setting (now current setting), you will know the default setting of your printer by printing the current matrix status. See page 3-19 to print out.
- Once recalled the FACTORY setting (now current setting) may be stored as a MACRO. See page 3-7 MACRO WRITE, starting at item #4.

F. QUIET mode

The Quiet mode reduces printing noise; however, it also reduces the printer's speed.

The printer can also store this function in any or all of the 3 MACROs as one of the printing conditions.

To simplify the MACRO setting process, you should set the Quiet mode **before** setting any other item on the control table.

1. Verify that the ON LINE/FUNCTION indicator is not blinking. (If blinking, press the **FUNCTION** switch.)
2. Press the **QUIET** switch to alternate the Quiet mode on and off.
 - The QUIET indicator shows you whether the Quiet mode is active (on) or not (off).

3.3 Feeding the paper

You can adjust the paper position by using the front panel switches when the printer is in the OFF LINE mode or when the printer is not printing in the ON LINE mode (but never in FUNCTION mode).

3

Form Feed

Pressing the **(FF)** switch advances the paper to the next top of form position.

Line Feed

Pressing the **(LF)** switch once advances the paper one line. Holding the switch will advance the paper continuously until the switch is released.

Micro Line Feed

Pressing the **(FF)** switch while pressing the **(ON LINE)** switch once advances the paper one micro line (1/180"). Holding the switch will advance the paper continuously until the switch is released.

When the PAPER OUT indicator is lit, pressing this will cause the platen to the micro line feed for ten seconds.

Reverse Micro Line Feed

Pressing the **(LF)** switch while pressing the **(ON LINE)** switch once reverses the paper one micro line (1/180"). Holding the switch will advance the paper continuously until the switch is released. The printer cannot reverse the paper into the non-printable area (See Appendix F).

Note:

- In the pull tractor mode, Reverse Micro-Line Feed will not feed paper correctly and the resulting print out may not be correct.
- When pressing the FF or LF switch, the amount of paper which is fed is determined by the current setting for lines per inch specified by the software command.

This printer has other special features for paper feeding.

A. Perforation Cut (P. CUT) (Rear feeding only)

3

This function allows you to advance your fanfold paper's perforation to the tear position. This is not dependent on your top of form position. After tearing off the page you can return your paper to your top of form.

1. Verify that the ON LINE/FUNCTION indicator is blinking. (If not, press the **FUNCTION** switch to enter the FUNCTION mode.)
2. Press the **QUIET** / P.CUT switch to advance the perforation to the tear bar.
3. Tear off the page.
4. Press the **QUIET** / P.CUT switch to reverse the paper back to the top of form.
—A Top of Form setting (see page 3-16) in the non-printable area is ignored by P.Cut. P.Cut will use the Top of Form setting that was last saved.
5. Press the **FUNCTION** switch to exit the FUNCTION mode.

B. Automatic Paper Loading (LOAD/PARK)

The paper bail lever performs a dual function. The use of this lever will reduce the steps and time it takes to load or park your paper (see the section "C. Paper Parking"). Listed in the chart below is a helpful guide on how the Bail Lever Feed will function with the various paper paths available.

	Paper Out	Paper Installed
Rear feeding	Loads Paper	Parks Paper
Single sheet	Feeds Paper	Feeds Paper
Cut Sheet Feeder	Loads Paper	No Action

Note:

When bottom feeding, do not use the automatic paper loading method, paper will not feed properly.

C. Paper Parking (Rear feeding only)

This function allows you to use single sheets or envelopes without removing or wasting your fanfold paper.

Parking the Fanfold Paper:

1. Verify that the Power is on and that the paper feed selector is in the "T" position.
2. Tear off the printed pages of the fanfold paper. (See Perforation Cut page 3-13.)
3. Pull the paper bail lever toward you to open the paper bail. Pull the lever to the "LOAD/PARK" position, then release. The printer will reverse feed the fanfold paper to the parked position.

Operation

Loading the Cut Sheet Paper: (also see Paper Installation section: Single Sheets and Envelopes page 2-13.)

3

1. Move the paper feed selector to the "F" position. Raise the top cover. Separate the paper guides to the approximate width of your paper. Insert the paper through the paper guides and behind the platen.
2. Pull the paper bail release lever to the "LOAD/PARK" position then release. This will load the paper automatically. When the paper stops moving move the lever to "T.PUSH/FRIC" position.
3. When you are finished printing, remove the sheet from the printer.

Reloading the Fanfold Paper

1. Lower the top cover.
2. Move the paper feed selector to the "T" position.
3. Pull the paper bail release lever to the "LOAD/PARK" position, then release. The fanfold paper will advance to the top of form which was set before using the single sheet.

D. Top of Form function (TOF SET)

This printer has a Top of Form function which stores the first print line position and loads the paper to the designated position automatically. The first print line position will be stored even after the power switch is turned off. Additionally, the printer can store the 3 different Top of Form positions depending on the paper feed method. [fanfold paper (T), single sheet (F) and single sheet using the Cut Sheet Feeder option: KX-P37.]

3

To Set the Top of Form

1. Set the FORM LENGTH of the paper you are using through the Control Table (see page 3-3) or software commands.
2. Load the paper by pulling the paper bail release lever. (see Section 2.7 for paper installation.)
 - The paper type you insert determines the first print line position for that type. (If using single sheets, you set the top of form for single sheets.)
 - The printer stores the 3 Top of Forms concurrently. However, each Top of Form (Single Sheets, Cut Sheet Feeder, Rear Feeding) must be set individually.
3. Adjust the paper position by using the LINE FEED, MICRO LINE FEED, or REVERSE MICRO LINE FEED. (see page 3-12)
 - Do not rotate the platen knob, the printer will not be able to count the number of lines.

Operation

3

4. Press the **FUNCTION** switch then the **ON LINE** (TOF SET) switch to set the Top of Form for that current position. See Note regarding beep indication.
 - A Top of Form position will be saved (between 0.7 and 5 inches from the top of page) even after the power switch is turned off. The paper bail lever pulled to the “LOAD/PARK” position will advance the paper to the most recently saved Top of Form setting.
 - A Top of Form position set in the area less than 0.7 inch and greater than 5 inches will not be saved; after the power switch is turned off, by parking the paper or by using P.Cut.
5. Press the **FUNCTION** switch to exit the Function mode.
6. Press the **ON LINE** switch (if the ON LINE indicator is off) to receive the data.

Note:

- Temporary Top of Form setting is indicated by one beep. Saved Top of Form is indicated by two beeps.
- When you use fanfold paper, the Top of Form position must be set on the first page, the printer does not accept a top margin which is longer than one page.
- When Bottom feeding, do not use this function.

3.4 Initial Setup mode

The printer allows the user to select 20 Initial Setup mode conditions. The printer uses the Control Table to select them instead of the conventional DIP switches.

To Enter the Initial Setup mode

Be sure that the power switch is off. Turn on the power switch while pressing the **FUNCTION** switch to enter the Initial Setup mode. The ON LINE/FUNCTION indicator light should be blinking. The Control Table on the front panel is replaced with the table on page 3-24.

When setting the Initial Setup, keep in mind that there are two types:

Individual the setting is either on or off.

Group the setting has a number of selections to choose from.

Setting the Initial Setup mode

1. Press and release the **ROW** switch until the desired ROW indicator combination is lit. (Refer to the Table on page 3-24.)
2. Press and release the **COLUMN** switch until the COLUMN indicator is lit over the desired setting. The indicator will inform you of the setting.
 - A lit indicator means the setting is ON, while a blinking indicator means the setting is OFF.
3. Press the **SET** switch to change the setting to reach the desired condition. With Groups, you must turn on one setting to turn off the previous setting within the Group.
4. After setting all the items you desire, press the **FUNCTION** switch to store them and exit the Initial Setup mode.

Operation

To Print Out the Current Settings

Before changing the items of the Initial Setup mode, you should verify the current settings.

3

1. Make sure that paper is installed, then turn the power off.
2. Power on while pressing the **FUNCTION** switch.
3. Verify that all row indicator are on or all row indicators are blinking.
4. Press the **SET** switch.

To Reset All Initial Setup Mode Settings to the FACTORY Default Setting

After powering on while pressing the **FUNCTION** switch.

1. Press the **QUIET** switch. A beep will sound.
2. Press the **SET** switch. A beep will sound.
—If you want to print out the current matrix condition, refer to page 3-19, item 3 and 4.
3. Press the **FUNCTION** switch to exit the Initial Setup mode.
—Before following above item #3, you should know the default setting of your printer by printing the current matrix condition. To print out, press the **SET** switch after selecting the condition which 3 ROW indicator lights are on or blinking.

3

Details of all items in the Initial Setup mode

- ① Printer emulation mode and character set mode (Group)
 - LQ-850 Italic Epson LQ-850 emulation, Italic character set
 - LQ-850 Graphic Epson LQ-850 emulation, Graphic character set 2
 - Proprinter X24G1 IBM Proprinter X24 emulation, Graphic character set 1
 - Proprinter X24G2 IBM Proprinter X24 emulation, Graphic character set 2
- ② Default print font mode (Group)

Selects one of 5 fonts-Draft, Courier, Prestige, Bold PS and Script

(This selection determines the default setting only when the font selection on the Control Table is in the PROGRAM mode.)
- ③ International character set mode (Group)

Selects one of the international, Legal character sets- USA, France, Germany, England, Denmark 1, Sweden, Italy, Spain 1, Japan, Norway, Denmark 2, Spain 2, Latin America and LEGAL (Refer to page A-7.)

Operation

3

- ④ Download buffer control mode (Individual)
ON Download is available (enable).
OFF Download is not available (disable).
[This setting is effective only when the 32K buffer option (KX-P43) is installed.]

- ⑤ Cut Sheet Feeder mode (Individual)
ON C.S.F. installed
OFF C.S.F. not installed
[This setting is effective only when the paper feed selector is in the "F" position and the cut sheet feeder option (KX-P37) is installed.]

- ⑥ Buzzer sound control mode (Individual)
ON Buzzer sounds.
OFF Buzzer does not sound.
(This setting is available only for BEL command.)

- ⑦ Zero font mode (Individual)
ON Zero (0)
OFF Zero slash (Ø)
(When the International Character Set is set to Norway, zero slash is printed as Ø.)

- ⑧ Alternate Graphic mode (AGM) (Individual)
ON Alternate Graphic mode ON
OFF Alternate Graphic mode OFF
(This setting is effective only in the IBM Proprinter X24 mode.)

- ⑨ Data length (Individual)
ON 7 bit data length
XOFF 8 bit data length

- ⑩ Print Direction (Image print) mode (Individual)
 - ON Unidirectional printing
 - OFF Bidirectional printing

- ⑪ Skip perforation mode (Individual)
 - ON Skip perforation 1 inch
 - OFF No skip

(This condition can also be changed through software commands.)

- ⑫ Automatic Line Feed mode (Individual)
 - ON CR+LF
 - OFF CR only

(This condition can also be changed through software commands.)

- ⑬ Automatic CR mode (Individual)
 - ON Causes Automatic CR on LF, VT, ESC+"J"
 - OFF Prevents Automatic CR on LF, VT, ESC+"J"

(This setting is effective only in the IBM Proprinter X24 mode.)

- ⑭ Paper Out Detector mode (Individual)
 - ON Detector is active.
 - OFF Detector is ignored.

(If using with Cut Sheet Feeder, the setting must be on.)

Operation

The following modes are available only when used with KX-PS10, RS-232C Serial interface board.

3

- ⑮ Baud rate mode (Group)
Selects one of 7 printer baud rates
150, 300, 600, 1200, 2400, 4800 or 9600

- ⑯ Parity control mode (Group)
Selects one of 4 parity controls
No parity, Ignore parity, Odd parity or Even parity

- ⑰ Protocol select mode (Individual)
ON X/ON-X/OFF Protocol
OFF DTR Protocol

- ⑱ Remaining buffer capacity to Suspend Data Transfer (S.D.T.) (X/OFF) (Individual)
ON 512 byte
OFF 128 byte

- ⑲ Remaining Buffer Capacity to Resume Data Transfer (R.D.T.) (X/ON) (Individual)
 - When the Suspend Data Transfer (S.D.T.) (X/OFF) is set to ON.
ON 768 byte
OFF 640 byte
 - When the S.D.T. is set to OFF.
ON 384 byte
OFF 256 byte

- ⑳ Designation of signal polarity for DTR protocol mode (Individual)
ON When the signal is "space", the printer tells the computer that it cannot accept transferring data.
OFF When the signal is "mark", the printer tells the computer that it cannot accept transferring data.

Initial Setup functions (See page 3-18 for detailed information.)

ROW Indicator			COLUMN Indicator (LED is on or blinking.)					
R1	R2	R3	C1	C2	C3	C4	C5	C6
ON	ON	ON	Print current matrix condition					
ON	OFF	OFF	① EPSON ITALIC	EPSON GRAHIC	IBM G1	IBM G2		
ON	ON	OFF	② DRAFT	COURIER	PRESTIGE	BOLD PS	SCRIPT	
OFF	ON	OFF	③ USA	FRANCE	GERMANY	ENGLAND	DENMARK 1	SWEDEN
OFF	ON	ON	ITALY	SPAIN 1	JAPAN	NORWAY	DENMARK 2	SPAIN 2
OFF	OFF	ON	LATIN AMERICA	LEGAL				
BLK	BLK	BLK	Print current matrix condition					
BLK	OFF	OFF	④ Buffer	⑤ Cut Sheet Feeder	⑥ Buzzer	⑦ Zero Slash	⑧ A.G.M.	⑨ Date Length
BLK	BLK	OFF		⑩ Print Direction	⑪ Skip Perforation	⑫ Auto LF	⑬ Auto CR	⑭ Paper Out Detector
OFF	BLK	OFF	⑮ 150	300	600	1200	2400	4800
OFF	BLK	BLK	9600		⑯ NO PARITY	IGNORE PARITY	ODD PARITY	EVEN PARITY
OFF	OFF	BLK	⑰ Protocol	⑱ S.D.T.	R.D.T.	⑳ Signal Polarity		

ROW indicator condition:

ON=light is lit BLK=light is blinking OFF=light is out.

3.5 Detectors

3

Paper Out detector

The Paper Out detector is located under the platen and senses the presence or absence of paper. When an out of paper condition occurs, the printing stops, the printer goes to the OFF LINE mode, the alarm sounds and the Paper Out light starts blinking. To continue printing to the end of the current page when an out of paper condition occurs, press the ON LINE switch repeatedly until the page is completed. To start printing the next page, install new paper and press the ON LINE switch. The printer will resume printing.

Note:

- The Paper Out detector can be disabled through the Initial Setup mode.

Overheat detector

If the printer is printing continuously for extended periods of time, the printhead may become overheated. When this occurs, an internal protective circuit will cause the printer to pause until the head temperature decreases sufficiently, at which time the printer will automatically resume printing without loss of data. This feature is included to extend the life of the printhead.

Overload detector

An overload condition can occur when the path of the printhead is blocked. At that time the carriage will stop moving and all indicator will blink. To resume printing, eliminate the cause of the overload then turn the power off and on again.

3.6 Initialization

The printer is initialized under the following conditions:

- the AC power is turned on
- the $\overline{\text{PRIME}}$ signal is received
- the RESET PRINTER command is received

When the printer is initialized, the following conditions are set:

- the print buffer is cleared
- the receive buffer is cleared (not cleared by RESET PRINTER command)
- the download character buffer is cleared (not cleared by $\overline{\text{PRIME}}$ signal in IBM Proprinter X24 mode or by RESET PRINTER command)
- the Initial Setup modes are read and set
- horizontal tabs are set every 8 columns
- vertical tab settings are cleared
- all modes set by control and escape commands will be cleared
- present form position is designated as top of form
- the Self Test mode is cleared
- the Control Table settings are read and set
- Control Panel settings are not changed by $\overline{\text{PRIME}}$ signal or RESET PRINTER command*
- the printhead goes to the home position

*Some software packages send $\overline{\text{PRIME}}$ signal at the beginning of their programs. Print modes set by the Control Table will not change.

Receive Buffer Clear Function

This function allows you to clear the receive buffer (information recently sent from the computer and is currently printing) without changing the Control Table settings. This feature is very useful when you find some mistakes while printing.

1. Press the **ON LINE** switch to stop the printing and enter the OFF LINE mode.
2. Press the **LF** switch while pressing the **FUNCTION** switch to clear the data in the receive buffer.

Operation

3.7 Hex Dump

3

In this mode, all data received from the computer is printed in hex code instead of the normal ASCII characters. Function codes for the printer (CR, LF, HT, etc.) are not executed. This mode is very useful to debug programs.

To enter the Hex Dump mode:

Turn the power on **while** pressing both **LF** and **FF** switches.

To release the Hex Dump mode:

Turn the power off, then back on.

4. Software Introduction

4.1 Introduction

In order for a computer to communicate with a printer, both pieces of equipment must understand a common language or coding scheme. One such coding scheme is called ASCII (American Standard Code for Information Interchange). For example, the ASCII code can express the character "K" in any of the following forms:

$(01001011)_2$ —Binary
4B_{HEX}, 4B_H—Hexadecimal
75_{DEC}, 75_D—Decimal

4

Many computers allow you to enter ASCII codes in either hexadecimal or decimal form. The entered ASCII codes are converted to binary form by the computer and then sent to the printer.

In the following sections, you will see how to enter various ASCII codes to enable the printer to perform the functions you would like. Since the decimal equivalent of the ASCII code is most commonly used, all examples which follow will use the decimal form.

Appendix A contains the ASCII characters and control command tables used by this printer.

4.2 Control Codes

The various printer functions are set through the use of control codes, which consist of one or more ASCII characters entered into the computer in a special way. These control codes often differ from printer to printer. Control codes generally fall into two categories: one-byte control codes and multi-byte control codes. The multi-byte control codes are often referred to as Escape Sequences since each code begins with the ASCII code for the ESCAPE character (ESC). Such an ESC character should not be confused with the Escape Key found on some computer keyboards.

Software Introduction

Control codes can be sent to this printer from your computer in different ways. The three most common ways are:

- Through commercial software packages
- Directly from the keyboard
- From within a user written program

4

The latter two methods will specifically reference the BASIC language, although other languages such as FORTRAN, PASCAL, etc., can also be used. We will use BASIC since it is a relatively easy language to use. In addition, it is one of the most commonly used microcomputer languages.

4.3 Entering Control Codes through Commercial Software Packages

Many computer users do not have the time, the expertise, or the interest to develop software suited for their applications. In such cases software written by professionals can be purchased. Such software should be selected not only to meet the needs of the user, but must also be compatible with both computer and printer.

Commercial software is often written with what is called a driver. A driver is that part of the software which allows the user to configure the package to the type of printer and interface being used. Once the software has been booted, the user is generally requested to supply additional information (based on emulation or compatibility setting) such as:

- Brand/Model/Emulation mode of printer being used.
- I/O port being used. (eg: LPT1, if a parallel interface is being used.)
- Baud rate, parity, etc. if a serial interface is being used.

But how do you know which mode to choose? The major factor to consider is which printer your software supports. Most commercial software packages include printer drivers that support one or more of the printers that this printer can emulate.

The installation program usually offers a menu of printers from which to choose. If you find this printer on the menu, select it.

1. Choices in order of priority: [If your Initial Setup mode (page 3-18 to 3-20) is set to Epson LQ-850]

We recommend that you inspect your software first. If it offers a menu of supported printers, select the printer mode in this order of preference:

- a. Panasonic KX-P1123
- b. Panasonic KX-P1124
- c. Epson LQ-850
- d. Epson LQ-2500
- e. Epson LQ Series

2. Choices in order of priority (IBM mode)

- a. IBM Proprinter X24

Once the necessary information has been supplied, the software will provide the computer with the control codes and other data needed by this printer.

Many word processing packages will request that you enter the ASCII codes used by this printer for special settings such as underlining, compressed print, super- and subscript, italics, etc. In all cases you should refer to your software instruction manual for the proper use of the package with this printer.

4.4 Entering Control Codes Directly from the Keyboard

4

With many computers, the BASIC language is ready to use once you power up. With others, BASIC must be loaded into memory. In any case, once BASIC is ready, you may then enter these printer control commands directly from your computer keyboard.

BASIC requires the use of the PRINT command (or LPRINT, PRINT#, etc. depending on the type of BASIC your computer uses) to process and send the control commands to this printer. As part of this print command, you must supply the appropriate ASCII code(s) for the character string (CHR\$) function.

For example, the command: **LPRINT CHR\$ (15)**(decimal code 15) followed by a **RETURN** will set this printer to compressed mode. Subsequent output to this printer will appear in compressed mode.

If, after issuing the above command, subsequent PRINT statements output nothing to the printer, check for one or more of the following.

- Have you indicated to the computer that output is to the printer and not the screen? For example, PR#1, allows subsequent PRINT statements on the Apple computer to PRINT to the printer and not the screen. LPRINT does the same in Microsoft BASIC.
- Is this printer on line (ON LINE/FUNCTION indicator is lit)? If not, press the green ON LINE button on the front panel.
- Is the interface cable plugged into the computer and printer?
- When using a serial interface, is the baud rate setting on the printer the same as that on the computer or interface card?

Notice that when you enter a BASIC command directly from the keyboard, you do NOT use a line number as you would in a BASIC program. Moreover, control codes may be entered only one line at a time.

4.5 Entering Control Codes from Within a Basic Program

Control codes may also be entered from within a BASIC program. The advantage to this technique is that you can incorporate a number of different control commands into a single program and therefore produce output with a variety of special features. This is done by RUNning your program once. In this case BASIC requires that each line in your program be preceded by a line number.

4

As an example, we mentioned earlier that the command **LPRINT CHR\$(15)** entered directly from the keyboard will set compressed print on this printer. From within a BASIC program, this command might be:

```
50 LPRINT CHR$(15)
```

4.6 Entering Hexadecimal Code

In the event that you will be entering ASCII codes in hexadecimal form, you must supply two extra characters per code. These are the ampersand (&) and the letter H. The example below illustrates the BASIC command to set compressed print on this printer.

Decimal
LPRINT CHR\$(15)

Hexadecimal
LPRINT CHR\$(&HOF)

Refer to Appendix A.

4.7 Control Codes

A number of the printer control commands require only a single ASCII-coded character as part of the LPRINT statement. The command **LPRINT CHR\$(15)** which we discussed earlier is an example of a single-byte control command.

Software Introduction

4

Multi-byte control codes, often called Escape control codes or Escape sequences, always begin with an ESC designation. ESC is designated by CHR\$(27) in decimal form or CHR\$(&H1B) in hexadecimal form. The ESC designation is always followed by one or more additional codes, hence the name multi-byte control code.

In BASIC, these two or more bytes are joined (or concatenated) into a single command or string using either a plus (+) sign, a semicolon(;), or by neither symbol but rather by listing one byte after another without any spaces. Refer to your BASIC manual for the proper method of string concatenation.

Table 4.1 and 4.2, on the following page, show equivalent methods of entering multi-byte control commands for most computers.

There is one remaining input format commonly used to reduce the keystrokes necessary to enter a multi-byte control command. As you examine the multi-byte control commands in the pages ahead, you will notice that the second byte, with the exception of ESC+“SO” and ESC+“SI”, is always a character which appears somewhere on your keyboard. In such cases rather than enter that character’s ASCII code as part of the CHR\$ function, you may simply enter that character in quotes (“”). For example, to set pica pitch (ESC+“P”), you may enter:

```
LPRINT CHR$(27)+“P”; or LPRINT CHR$(27)+CHR$(80);
```

As another example, to set double wide printing, you may enter:

```
LPRINT CHR$(27)+“W”+CHR$(1);  
or  
LPRINT CHR$(27)+CHR$(87)+CHR$(1);
```

With this method, any of the three input formats shown in Table 4.1 and 4.2 may also be used (subject to the BASIC you are using).

	Two-Byte Command
Function Name Code	Set Pica Pitch ESC+"P" 27, 80 _{DEC}
Input Format 1	LPRINT CHR\$(27)+"P";
Input Format 2	LPRINT CHR\$(27);"P";
Input Format 3	LPRINT CHR\$(27)"P";

Table 4.1 Two-Byte Command Input Format

	Three-Byte Command
Function Name Code	Set Double Wide Printing ESC+"W"+1 27,87, 1 _{DEC}
Input Format 1	LPRINT CHR\$(27)+"W"+CHR\$(1);
Input Format 2	LPRINT CHR\$(27);"W";CHR\$(1);
Input Format 3	LPRINT CHR\$(27)"W"CHR\$(1);

Table 4.2 Three-Byte Command Input Format

This printer has two printer emulations. They are Epson LQ-850 and IBM Proprinter X24. Software commands for each emulation are covered in the corresponding chapters.

4.8 Special Code IBM PC or Compatible

Since the LPRINT command on IBM PC or compatible can generate an unexpected LF together with a CR, use PRINT #1 instead of LPRINT. For details refer to your BASIC manual. The following two lines of BASIC are necessary at the top of the program.

```
10 WIDTH "LPT1:", 255
20 OPEN "LPT1:" AS #1
```

The following line of BASIC is necessary at the end of the program:
 100 CLOSE (Line # may vary according to your program)
 PRINT #1 does not generate CR and LF, therefore a CR and LF must be used when they are required.

5. KX-P1123 Features

5.1 Print Feature Controls

This printer has a wide variety of print capabilities as shown below. The user can select any print mode by combining quality, font, font style, pitch and highlight giving you more than 5,500 different print styles to customize the look of your particular document.

Quality	Font	Font Style	Pitch	Highlight
Draft	Draft	Subscript	10	Double high
Letter Quality	Courier	Superscript	12	Double wide
	Prestige	Italic	15	Double strike
	Bold PS		17	Emphasized (Bold)
	Script		20	Underline
			PS	Overline*

*Available only in IBM Proprinter X24 mode.

Print Quality and Font

This printer has two print quality levels: Draft and Letter Quality. Which you choose depends on your needs. Draft is printed at the fastest speed and is normally used for printing draft documents. Letter quality produces the best print quality; it is used to print the final version of formal documents.

The printer has four letter quality fonts: Courier, Prestige, Bold PS and Script; and three Draft fonts: Pica, Elite and Micron. These can be selected either by setting the Control Table on the EZ Set Operator Panel or through software.

Super/subscript font characters are two-thirds the height of normal characters and are typically used in mathematical expressions, chemical formulae and footnotes.

Character Pitch

This printer has six character pitches: 10 cpi (Pica), 12 cpi (Elite), 15 cpi (Micron), 17 cpi (Compressed), 20 cpi (Elite compressed) and Proportional Spacing. The height of the characters in the different pitches is the same; only the width varies. The first five pitches are fixed pitch (within a pitch, all characters have the same width).

In proportional spacing, character widths vary with the character. An "I", for example, takes up less space than an "M" or a "W". Proportional printing gives the document a typeset appearance. **Proportional spacing cannot be printed in draft mode.**

(Print Example)

10 cpi printing (Pica)
12 cpi printing (Elite)
15 cpi printing (Micron)
17 cpi printing (Compressed)
20 cpi printing (Elite compressed)
PS printing (Proportional spacing)

5

Character Highlighting

This printer allows a document to have a variety of print styles through the mixing of fonts and pitches.

Double high printing makes the height of a character twice that of a normal one.

Double wide printing makes the width of a character twice that of a normal one.

Double strike printing uses a double strike with two passes of the printhead.

Emphasized printing is done with one pass of the printhead at half speed, which allows horizontally adjacent dots to be printed.

Underline printing produces a continuous line under characters, using the 24th pin of the printhead.

Overline printing produces a continuous line over characters using the first pin of the printhead.

(Print Example)

Double High
Double Wide
Double Strike Printing
Emphasized Printing
Underline Overline Printing

5.2 Download Characters

Should you need to custom design special characters in addition to those provided, the 32K byte buffer option (KX-P43), is required. Draft and Letter Quality (LQ) fonts can be downloaded simultaneously. Draft download characters are printed when the printer is in draft mode, LQ characters are printed when the printer is in LQ mode.

5

To download a character you must first make preparations for:
—Installing the 32K buffer option (KX-P43).
—Download buffer selection is set to ON (DLL Enable) in the Initial Setup mode.

Making Maximum Use of the Buffer

Epson LQ-850 mode

18K (18,432) bytes are available which can be divided between draft and letter quality characters in any combination, subject to hexadecimal address and buffer limits. Draft letters each require 39 bytes maximum while LQ letters require 114 maximum. To determine if the desired combination will fit, use the formula:

$$(\# \text{ of draft characters} \times 39) + (\# \text{ of LQ characters} \times 114) \leq 18,432$$

For example: 120 draft and 120 letter quality are desired.

$$(120 \times 39) + (120 \times 114) = 4,680 + 13,680 = 18,360$$

therefore this combination will fit.

Because no more than 256 addresses can be identified in 1 byte (00_{HEX}-FF_{HEX}), 256 is the maximum number of draft characters that can be defined. The maximum number of LQ characters that can be loaded is 161.

IBM Proprinter X24 mode

The 32K bytes available can be divided between draft and LQ characters in any combination. The download data also can be entered to RAM by compression. The maximum number of characters depends on the manner in which the characters are entered.

Designing Download Characters

1. Draft Font

To download a character you must first design the character. A draft font download character uses 9 columns and 24 rows of dots. Since a given column contains 24 dots, each column is divided into 3 portions, upper 8, middle 8 and lower 8 dots. Column 1 is labeled P_{1H} for the upper 8 dots, P_{1M} for the middle 8 and P_{1L} for the lower 8 dots. Similarly column 9 is labeled P_{9H} for the upper 8 dots, P_{9M} for the middle 8 and P_{9L} for the lower 8 dots. Columns 10, 11 and 12 are always set to zero, thus we are working with P_{1H} through P_{9L} .

In the matrix below, the circles represent pins which may be fired. You may darken any circle provided no two adjacent horizontal circles are filled in. Once you have designed the character, you must quantify each dot column, P_{1H} - P_{9H} , by summing the powers of two represented by each dot. Consider the design of the Greek character gamma.

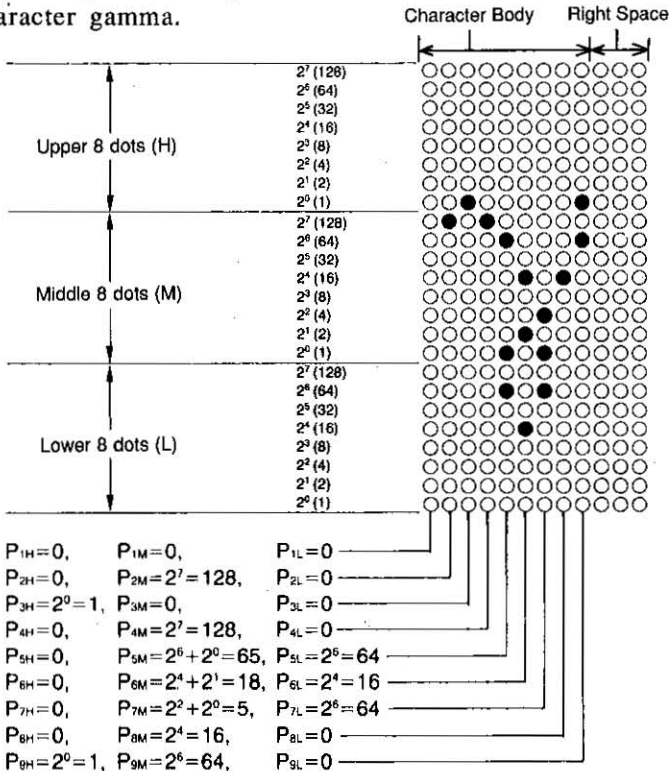

KX-P1123 Features

2. LQ Font

A LQ font download character uses 36 columns and 24 rows of dots. Designing and storing fonts can be performed in the same way as with draft fonts. Here, consider the design of the one-eighth-note character:

5

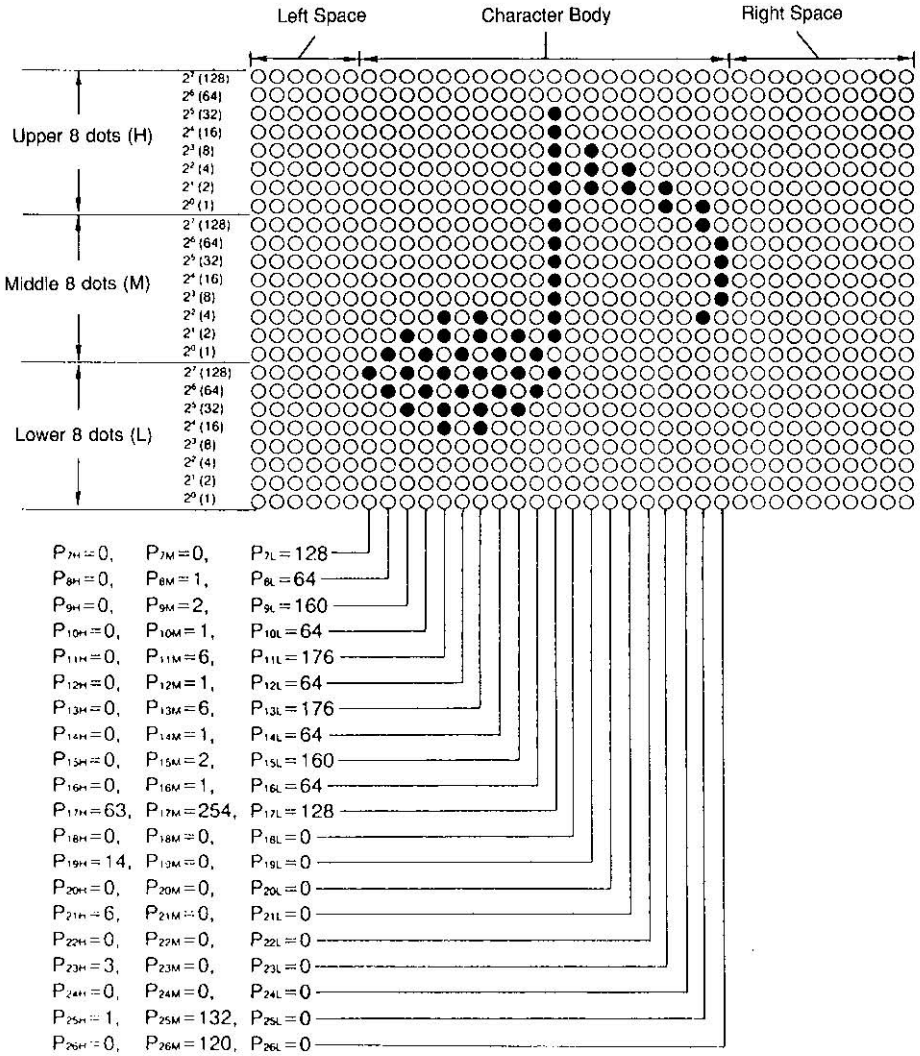

Entering Download Data

Epson LQ-850 mode

1. Draft Font

Download command in the Epson LQ-850 mode is:

ESC+"&" + 0 + n + m + d₀ + d₁ + d₂ + DATA

Input format for download command is:

LPRINT CHR\$(27)+"&" + CHR\$(0) + CHR\$(n) + CHR\$(m)
+ CHR\$(d₀) + CHR\$(d₁) + CHR\$(d₂) + DATA

Programming example for the Greek character gamma is as follows:

5

```

10 REM Draft Download Character
20 WIDTH "LPT1:",255
30 OPEN "LPT1:" AS #1
40 PRINT #1,CHR$(27)+"x0";
50 PRINT #1,CHR$(27)+" "+CHR$(0)+CHR$(0)+CHR$(0);
60 PRINT #1,CHR$(27)+"&" +CHR$(0)+CHR$(65)+CHR$(65);
70 PRINT #1,CHR$(1)+CHR$(8)+CHR$(3);
80 PRINT #1,CHR$(0)+CHR$(128)+CHR$(0);
90 PRINT #1,CHR$(1)+CHR$(0)+CHR$(0);
100 PRINT #1,CHR$(0)+CHR$(128)+CHR$(0);
110 PRINT #1,CHR$(0)+CHR$(65)+CHR$(64);
120 PRINT #1,CHR$(0)+CHR$(18)+CHR$(16);
130 PRINT #1,CHR$(0)+CHR$(5)+CHR$(64);
140 PRINT #1,CHR$(0)+CHR$(16)+CHR$(0);
150 PRINT #1,CHR$(1)+CHR$(64)+CHR$(0);
160 REM Download character print
170 PRINT #1,CHR$(27)+"%" +CHR$(1);
180 PRINT #1,"A A A A A A A A";CHR$(10);
190 PRINT #1,CHR$(27)+"%" +CHR$(0);
200 END
    
```

First determine where in RAM the character(s) should be stored. The variables n and m are used for this purpose. The value specified for n indicates the location into which the first download character will be stored. The value specified for m indicates the location into which the last download character will be stored. If you are storing a single character, then n=m.

Next define the value of d₀, d₁ and d₂ which specify attribute information. The attribute information includes the following:

d₀=number of space dot columns to the left of the character body

d₁=number of character body dot columns

d₂=number of space dot columns to the right of the character body

KX-P1123 Features

In our sample program, we created a gamma character. This character consists of 1 left space dot column, 8 body dot columns and 3 right space dot columns. Therefore, $d_0=1$, $d_1=8$ and $d_2=3$. In general, d_i cannot exceed 9 and $d_0+d_1+d_2$ cannot exceed 12.

Note:

- Program line 40 is necessary for downloading draft font and designates draft printing.
- Program lines 80~1150 use the eight values $P_{2H} \sim P_{9L}$ to define the shape and size of the gamma.
- Program line 170 selects download character generator. After this selection, by printing the download code [in this example, $\text{CHR}\$(65) = \text{"A"}$] the downloaded character is printed.
- Two horizontal adjacent columns cannot be printed in either draft or LQ mode.

2. LQ Font

Input format is the same as with draft fonts.

Programming example for the one-eighth-note character is as follows:

```

10 REM Define Download Letter Quality Character
20 WIDTH "LPT1:",255
30 OPEN "LPT1:" AS #1
40 PRINT #1,CHR$(27)+"x1";
50 PRINT #1,CHR$(27)+": "+CHR$(0)+CHR$(0)+CHR$(0);
60 PRINT #1,CHR$(27)+"&"+CHR$(0)+CHR$(65)+CHR$(65);
70 PRINT #1,CHR$(6)+CHR$(20)+CHR$(10);
80 PRINT #1,CHR$(0)+CHR$(0)+CHR$(128);
90 PRINT #1,CHR$(0)+CHR$(1)+CHR$(64);
100 PRINT #1,CHR$(0)+CHR$(2)+CHR$(160);
110 PRINT #1,CHR$(0)+CHR$(1)+CHR$(64);
120 PRINT #1,CHR$(0)+CHR$(6)+CHR$(176);
130 PRINT #1,CHR$(0)+CHR$(1)+CHR$(64);
140 PRINT #1,CHR$(0)+CHR$(6)+CHR$(176);
150 PRINT #1,CHR$(0)+CHR$(1)+CHR$(64);
160 PRINT #1,CHR$(0)+CHR$(2)+CHR$(160);
170 PRINT #1,CHR$(0)+CHR$(1)+CHR$(64);
180 PRINT #1,CHR$(63)+CHR$(254)+CHR$(128);
190 PRINT #1,CHR$(0)+CHR$(0)+CHR$(0);
200 PRINT #1,CHR$(14)+CHR$(0)+CHR$(0);
210 PRINT #1,CHR$(0)+CHR$(0)+CHR$(0);
220 PRINT #1,CHR$(6)+CHR$(0)+CHR$(0);
230 PRINT #1,CHR$(0)+CHR$(0)+CHR$(0);
240 PRINT #1,CHR$(3)+CHR$(0)+CHR$(0);
250 PRINT #1,CHR$(0)+CHR$(0)+CHR$(0);
260 PRINT #1,CHR$(1)+CHR$(132)+CHR$(0);
270 PRINT #1,CHR$(0)+CHR$(120)+CHR$(0);
280 REM Download character print
290 PRINT #1,CHR$(27)+"%"+CHR$(1);
300 PRINT #1,"A A A A A A A A A A"
310 PRINT #1,CHR$(27)+"%"+CHR$(0);
320 END
    
```

The number of printable columns for characters downloaded in the letter quality font is as follows:

	$d_0+d_1+d_2$
LQ 10 cpi	36
LQ 12 cpi	30
Proportional Spacing	42

Print Mode Combination:

- Draft Download characters can be printed only when the FONT is set to "PROGRAM" or Draft on the Control Table.
- Letter quality download characters can be printed only when the FONT is set to "PROGRAM" or Courier, Prestige, Bold PS, Script on the Control Table.

KX-P1123 Features

Super/subscript characters

To download a super/subscript character, you have to enter the super/subscript mode before defining the characters (by using the command ESC+"S"+n). In this mode, the received data is then processed as data for super/subscript. Since the super/subscript character is only $\frac{2}{3}$ the height of normal character (16 dots vs. 24 dots high), it needs only two bytes data for each column.

The defined character is used either as a superscript or as a subscript character.

The only difference is the location of printed character. The superscript character is printed in the upper $\frac{2}{3}$ position of the normal character cell, while the subscript characters is in the lower $\frac{2}{3}$ position of that cell. You can select the one which you want by changing the value of n on the command. (n=0: superscript, n=1: subscript)

The table below shows the maximum values allowable.

	height	width	
		d ₁	d ₀ +d ₁ +d ₂
Draft	16	7	12
Letter Quality	16	23	36
PS	16	23	42

Note

- When you download Draft or LQ character in this mode, the pitch keeps normal width though the font is reduced to $\frac{2}{3}$ width.
- In PS mode, the font and pitch are reduced to $\frac{2}{3}$ original width.

IBM Proprinter X24 mode

Downloading fonts in IBM Proprinter X24 mode requires downloading character Dot Pattern data and character Index Table data. Dot pattern data controls which pins fire when printing a character, Index Table data is placed in a "lookup table" that provides information on where Dot Pattern data is stored in memory and defines certain attributes of the character.

The format for the command to input download data is:

ESC + "=" + $n_1 + n_2 + 35 + A_1 + A_2 + d_1 + d_2 + \dots + d_x$

where

$n_1 + (256 \times n_2)$ = the number of data bytes to be downloaded, 35 is a fixed number that must always be sent, A_1 and A_2 indicate the low order and high order addresses in which data is to be stored, and d_1, d_2, \dots is the data being downloaded. This data will be in one of two formats, depending on whether it is Dot Pattern or Index Table:

Index Table Addresses

Starting memory addresses for Index Tables are:

Draft (10 and 12 cpi)	8011 _{HEX}
LQ 10 cpi	8912 _{HEX}
LQ Proportional	9213 _{HEX}
LQ 12 cpi	9B14 _{HEX}

To calculate the address for an individual character Index Table entry, use the equation:

Address = $9 \times$ ASCII character number + starting address.

To find the address of the Index Table location for the draft letter "A":

Multiply 9×65 (ASCII character number for "A") = 585_{DEC}
Convert to hexadecimal = 249_{HEX}
Add starting address for draft = 8011_{HEX}
yielding 825A_{HEX} making $A_1 = 5A_{HEX}$, and $A_2 = 82_{HEX}$.

KX-P1123 Features

Dot Pattern Data

Dot Pattern data is sent for all columns that must be uniquely defined. If adjacent horizontal columns are identical (or can be made identical knowing that the printer will not print adjacent horizontal dots) data compression may be used and the duplicate data need not be sent. Dot Pattern data may be stored at any address from A414_{HEX} to FFFF_{HEX} inclusive.

Dot columns for characters are as follows:

Draft (10 and 12 cpi) . 10 columns
LQ 10 cpi 36 columns
LQ 12 cpi 30 columns
LQ Proportional ...18~42 columns

It is important to note that the last column is always blank. (e.g. A download draft character is defined by 9 columns. The printer automatically adds the tenth column.)

$$\text{Data} = P_{1H} + P_{1M} + P_{1L} + P_{2H} + P_{2M} + P_{2L} + \dots + P_{nH} + P_{nM} + P_{nL}$$

Index Table Data

$$AA_1 + AA_2 + IT_1 + IT_2 + CM_1 + \dots + CM_5$$

where

AA₁ and AA₂ indicate the address where Dot Pattern data is stored.

AA₁ and AA₂ are the high order and the low order bytes respectively.

IT₁ is Index Table byte #1. Bit designation is:

Bit	0	1
7	Normal Character	Graphic Character
6	Download Character	Resident Character
5~0	Number of columns in the character memory	

IT₂ is Index Table byte #2. Bit designation is:

Bits 7, 6 Type of block graphic character

00	shading character
01	line drawing character
10	underscore character
11	not supported

Bits 5~0 number of columns in the character less 1
 [e.g. for draft characters, 10-1=9_{DEC}=(001001)₂
 bits 5~0=001001]

CM₁~CM₅ are compression mask bits.
 (0=no compression, 1=compression)

CM₁ bit 7=1st dot column
 bit 6=2nd dot column

·
·
·
·

CM₅ bit 3=37th dot column
 bit 2=38th dot column
 bit 1=39th dot column
 bit 0=40th dot column

KX-P1123 Features

Note:

- All block graphic characters are 30 dots high, even though only 24 dots are defined for each column. An underline is defined as a blank block graphic character (all zeros). The underline is generated by the printer during the second pass. A shadow character repeats dots 1~6 of each column as dots 25 through 30 respectively. A line draw character repeats dots 23 and 24 as the pairs 25 and 26, 27 and 28, and 29 and 30.
- Entry data can designate any character data image whether resident or downloaded. Multiple table entries can designate the same character. The address of an undefined entry should be 000. An undefined entry is printed as a space.
- Location 0 (00_{HEX}) normally stores the slashed zero. If a character is downloaded into this location, when the slashed zero is selected in the Initial Setup mode, the downloaded character will print in place of any zero.

5

Data Compression

Data Compression allows the efficient use of memory in storing downloaded characters providing space for more characters than would be available without compression. The printer repeats the previous dot column in the current column when the current column compression mask bit is set to 1.

Resetting Download Area

Issuing the command ESC+“=”+0+0 initializes the download area. All previously downloaded characters are cleared and the Index Tables are loaded with information for resident fonts.

Programming Examples:

To load draft characters used in the example for the Epson LQ-850 mode (Greek gamma), the following program may be used.

```
10 REM Greek Gamma Character Download and print
20 WIDTH "LPT1:",255
30 OPEN "LPT1:" AS #1
40 REM---(Initialize the Download Buffer)
50 PRINT #1,CHR$(27)+"="+CHR$(0)+CHR$(0);
60 REM---(Dot Pattern Data Entry to ASCII "A")
70 PRINT #1,CHR$(27)+"="+CHR$(30)+CHR$(0)+CHR$(35);
80 PRINT #1,CHR$( &H0)+CHR$( &H0);
90 PRINT #1,CHR$(0)+CHR$(128)+CHR$(0);
100 PRINT #1,CHR$(1)+CHR$(0)+CHR$(0);
110 PRINT #1,CHR$(0)+CHR$(128)+CHR$(0);
120 PRINT #1,CHR$(0)+CHR$(65)+CHR$(64);
130 PRINT #1,CHR$(0)+CHR$(18)+CHR$(16);
140 PRINT #1,CHR$(0)+CHR$(5)+CHR$(64);
150 PRINT #1,CHR$(0)+CHR$(16)+CHR$(0);
160 PRINT #1,CHR$(1)+CHR$(64)+CHR$(0);
170 PRINT #1,CHR$(0)+CHR$(0)+CHR$(0);
180 REM---(Index Table Entry to ASCII "A")
190 PRINT #1,CHR$(27)+"="+CHR$(12)+CHR$(0)+CHR$(35);
200 PRINT #1,CHR$( &H5A)+CHR$( &H2);
210 PRINT #1,CHR$( &H0)+CHR$( &H0)+CHR$(8);
220 PRINT #1,CHR$(10)+CHR$(0)+CHR$(0);
230 PRINT #1,CHR$(0)+CHR$(0)+CHR$(0);
240 REM---(Download Character print)
250 PRINT #1,CHR$(27)+"I"+CHR$(4);
260 FOR I=1 TO 10
270 PRINT#1,"A";
280 NEXT
290 PRINT #1,CHR$(13);CHR$(10);
300 CLOSE #1
310 END
```

In this example of Greek gamma, a character is not compressed and data of CM₁ through CM₅ are all zeros.

KX-P1123 Features

To load LQ characters, the input format is the same as with draft fonts. Programming example for the one-eighth-note character is as follows:

```
10 REM One-eighth-note Character Download and print
20 WIDTH "LPT1:",255
30 OPEN "LPT1:" AS #1
40 REM---(Initialize the Download Buffer)
50 PRINT #1,CHR$(27)+"="+CHR$(0)+CHR$(0);
60 REM---(Dot Pattern Data Entry to ASCII "B")
70 PRINT #1,CHR$(27)+"="+CHR$(45)+CHR$(0)+CHR$(35);
80 PRINT #1,CHR$(&H0)+CHR$(&H0);
90 PRINT #1,CHR$(0)+CHR$(0)+CHR$(0);
100 PRINT #1,CHR$(0)+CHR$(0)+CHR$(128);
110 PRINT #1,CHR$(0)+CHR$(1)+CHR$(64);
120 PRINT #1,CHR$(0)+CHR$(3)+CHR$(224);
130 PRINT #1,CHR$(0)+CHR$(7)+CHR$(240);
140 PRINT #1,CHR$(0)+CHR$(3)+CHR$(224);
150 PRINT #1,CHR$(0)+CHR$(1)+CHR$(64);
160 PRINT #1,CHR$(63)+CHR$(254)+CHR$(128);
170 PRINT #1,CHR$(14)+CHR$(0)+CHR$(0);
180 PRINT #1,CHR$(6)+CHR$(0)+CHR$(0);
190 PRINT #1,CHR$(3)+CHR$(0)+CHR$(0);
200 PRINT #1,CHR$(1)+CHR$(132)+CHR$(0);
210 PRINT #1,CHR$(0)+CHR$(120)+CHR$(0);
220 PRINT #1,CHR$(0)+CHR$(0)+CHR$(0);
230 REM---(Index Table Entry to ASCII "B")
240 PRINT #1,CHR$(27)+"="+CHR$(12)+CHR$(0)+CHR$(35);
250 PRINT #1,CHR$(&H64)+CHR$(&H8B);
260 PRINT #1,CHR$(&H0)+CHR$(&H0)+CHR$(14);
270 PRINT #1,CHR$(35)+CHR$(124)+CHR$(90);
280 PRINT #1,CHR$(85)+CHR$(47)+CHR$(240);
290 REM---(Download Character print)
300 PRINT #1,CHR$(27)+"I"+CHR$(6);
310 FOR I=1 TO 10
320 PRINT#1,"B";
330 NEXT
340 PRINT #1,CHR$(13);CHR$(10);
350 CLOSE #1
360 END
```

Note:

- The left most column of adjacent identical columns has its compression mask bit set to 0 and that bit in the other such columns is set to 1.
- Entry data can designate any character data image whether resident or downloaded. Multiple table entries can designate the same character. The address of an undefined entry should be 000. An undefined entry is printed as a space.
- Location 0 (00_{HEX}) normally stores the slashed zero. If a character is downloaded into this location, when the slashed zero is selected in the Initial Setup mode, the downloaded character will print in place of any zero.
- ASCII character in location 255 (FF_{HEX}) cannot be defined.

5.3 Bit Image (Graphics)

Bit image (Graphics) is used to produce pictures, graphs, charts or creative patterns. Many commercial software packages use bit images. This printer has six 8-pin bit image modes and five 24-pin bit image modes within the LQ-850 mode, and has four 8-pin/24-pin bit image modes within the IBM Proprinter X24 mode, so that you have a wide variety of image printing. When you use a commercial software package you should refer to your software instruction manual for the proper use of it with this printer. Each printer mode has its own bit image commands. Because differences between the two modes are small, only the LQ-850 mode is used here as an example of how to print bit images through software commands.

KX-P1123 Features

Dot Density

Dot density (dot resolution) refers to the maximum number of dots which can be printed in an inch or on a line. This printer enables you to access a variety of dot densities through specific control commands. The various dot densities and corresponding control commands appear in Table 5.1.

5

Command	Function	Dots/Inch	Dots/line
ESC+"K"+n ₁ +n ₂	Standard density	60	480
ESC+"L"+n ₁ +n ₂	Double density	120	960
ESC+"Y"+n ₁ +n ₂	Double speed, Double density	120	960
ESC+"Z"+n ₁ +n ₂	Quadruple density	240	1920
ESC+"*" +m+n ₁ +n ₂	8-pin Mode Selection:		
	m=0 (Standard)	60	480
	m=1 (Double)	120	960
	m=2 (Double speed, Double density)	120	960
	m=3 (Quadruple density)	240	1920
	m=4 (CRT I)	80	640
	m=6 (CRT II)	90	720
	24-Pin Mode Selection:		
	m=32 (Standard)	60	480
	m=33 (Double)	120	960
	m=38 (CRT III)	90	720
	m=39 (Triple)	180	1440
	m=40 (Hex)	360	2880
ESC+"["+"g"+n ₁ +n ₂ +m	8-pin Mode Selection:		
	m=0 (Standard)	60	480
	m=1 (Double)	120	960
	m=2 (Double speed, Double density)	120	960
	m=3 (Quadruple density)	240	1920
	24-Pin Mode Selection:		
	m=8 (Standard)	60	480
	m=9 (Double)	120	960
	m=11 (Triple)	180	1440
	m=12 (Hex)	360	2880

Table 5.1 Dot Density

8-Pin Bit Image Mode

This printer has 24 pins in the printhead. The distance between the centers of adjacent pins $1/180''$ (0.14 mm) and the diameter of each pin is $1/127''$ (0.2 mm). In 8-pin bit image mode the 24 pins of the printhead are grouped as follows. One byte is sent to the printer for each column to be printed. Each bit of that byte represents an individual pin-block. By summing the powers of two corresponding to each pin-block you wish to fire, you will obtain a numerical value for the column in question. By sending a string of bytes, numerical values for each column on a line are input and processed. The result is one line of graphics.

Pin-block	Pin-block Code	Pins	Pin No.	Pin-block Code	Pin-block
1	$2^7=128$	<ul style="list-style-type: none"> ••••••••••••••••••••••• 	1	$2^7=128$	1
			2		
			3		1 and 2
			4		
2	$2^6=64$		5	$2^6=64$	2
			6		
			7		
3	$2^5=32$		8	$2^5=32$	3
			9		3 and 4
			10		
4	$2^4=16$		11	$2^4=16$	4
			12		
			13	$2^3=8$	5
			14		5 and 6
5	$2^3=8$		15		
			16	$2^2=4$	6
			17		
6	$2^2=4$		18	$2^1=2$	7
			19		7 and 8
7	$2^1=2$		20		
			21	$2^0=1$	8
			22		
8	$2^0=1$		23		} Not used
			24		

LQ-850 mode and
 IBM Proprinter X24 mode
 (Alternate Graphic Mode: ON)

IBM Proprinter X24 mode
 (Alternate Graphic Mode: OFF)

KX-P1123 Features

Note:

- In the LQ-850 mode or IBM Proprinter X24 mode with Alternate Graphic Mode (AGM) set to ON in the Initial Setup mode, 8-pin bit image graphics is printed by using all 24 pins in the printhead.

As an example, suppose you want to fire pin-blocks 1, 2, 5 and 8 simultaneously. Then you compute the following sum:

Input code=Pin-block 1 code+Pin-block 2 code+
Pin-block 5 code+Pin-block 8 code
 $=2^7+2^6+2^3+2^0=128+64+8+1=201$

5

Thus, the value 201 is entered in the CHR\$ function in order to print a single column of dots resulting from firing pin-blocks 1, 2, 5 and 8.

For our final example, refer to the standard density designation in Table 5.1. This setting is given by ESC+“K”+ n_1+n_2 . Suppose you wish to print 100 columns of dots, where every column fires pins 1 and 8 only. You first compute the values of n_1 and n_2 which define the number of columns to be printed.

$$\begin{array}{r} 0 \ (n_2) \\ 256 \overline{) 100} \\ \underline{ 0} \\ 100 \ (n_1) \end{array} \quad , \text{so } n_2=0 \text{ and } n_1=100$$

Our control code ESC+“K”+ n_1+n_2 now translates into:

LPRINT CHR\$(27)+“K”+CHR\$(100)+CHR\$(0);

If you use ESC+“[”+“g”+ n_1+n_2+m in IBM Proprinter X24 mode, compute the values of n_1 and n_2 is as follows:

$$n_2 \times 256 + n_1 = \text{Column} \times \text{Bytes} + 1$$

m=0, 1, 2, 3: Bytes=1
m=8, 9, 11, 12: Bytes=3

For example, 24-pin bit image of 100 column is:

$$100 \times 3 + 1, \text{ so } n_2=1 \text{ and } n_1=45.$$

KX-P1123 Features

A programming example is as follows:

24/180" Line space set

```
10 REM STANDARD DENSITY
20 WIDTH "LPT1:",255
30 OPEN "LPT1:" AS #1
40 PRINT #1,CHR$(27)+"3"+CHR$(24);
50 PRINT #1,CHR$(27)+"K"+CHR$(100)+CHR$(0);
60 FOR I=1 TO 5
70 PRINT #1,CHR$(1)+CHR$(2)+CHR$(4)+CHR$(8)+CHR$(16);
80 PRINT #1,CHR$(32)+CHR$(64)+CHR$(128)+CHR$(64)+CHR$(128);
90 PRINT #1,CHR$(64)+CHR$(128)+CHR$(64)+CHR$(128)+CHR$(64);
100 PRINT #1,CHR$(32)+CHR$(16)+CHR$(8)+CHR$(4)+CHR$(2);
110 NEXT I
120 PRINT #1,CHR$(10);CHR$(13);
130 PRINT #1,CHR$(27)+"K"+CHR$(100)+CHR$(0);
140 FOR I=1 TO 5
150 PRINT #1,CHR$(128)+CHR$(64)+CHR$(32)+CHR$(16)+CHR$(8);
160 PRINT #1,CHR$(4)+CHR$(2)+CHR$(1)+CHR$(2)+CHR$(1);
170 PRINT #1,CHR$(2)+CHR$(1)+CHR$(2)+CHR$(1)+CHR$(2);
180 PRINT #1,CHR$(4)+CHR$(8)+CHR$(16)+CHR$(32)+CHR$(64);
190 NEXT I
200 PRINT #1,CHR$(10);CHR$(13);
210 CLOSE
220 END
```



1st line data

2nd line data

5

Note:

- Line 20 and 30 are necessary for the proper execution of this program on many IBM-compatible computers.
- Line 40 is necessary to set the line feed for printing in the bit image mode. In the IBM Proprinter X24 mode, when AGM is set to OFF in the Initial Setup mode, it will amount to 24/216 inch.

KX-P1123 Features

24-Pin Bit Image Mode

In the 24-pin bit image mode, all 24-pins of the printhead may be fired. In this mode, 3 data bytes must be sent to the printer for each column. The 24 pins in the printhead are divided into three portions, the upper 8 pins, middle 8 pins and lower 8 pins.

As an example, suppose you want to fire pins 1, 2, 5, 8, 9, 11, 12, 21 and 24 simultaneously. Then you compute the following three values:

Byte 1: Input code=Pin 1 code+Pin 2 code+Pin 5 code+Pin 8 code
 $=2^1+2^2+2^3+2^0=128+64+8+1=201$

Byte 2: Input code=Pin 9 code+Pin 11 code+Pin 12 code
 $=2^7+2^5+2^4=128+32+16=176$

Byte 3: Input code=Pin 21 code+Pin 24 code= $2^3+2^0=8+1=9$

Thus, the three bytes for a single column of dots are entered as CHR\$(201);CHR\$(176);CHR\$(9); Refer to the 24-pin standard density command in Table 5-1. This setting is given by ESC+ "*" +m+n₁+n₂, where m=32. Suppose you wish to print 100 columns of dots, where every column fires pins 1, 2, 5, 8, 9, 11, 12, 21 and 24 as above.

As in the 8-pin example on page 5-18, n₁=100 and n₂=0. Our command ESC+ "*" +m+n₁+n₂ now translates into

LPRINT CHR\$(27)+"*" +CHR\$(32)+CHR\$(100)+CHR\$(0);

If we incorporate this information into a program, we might have the following:

```
10 REM 24 PIN STANDARD DENSITY
20 WIDTH "LPT1:" ,255
30 OPEN "LPT1:" AS #1
40 PRINT #1,CHR$(27)+"*" +CHR$(32)+CHR$(100)+CHR$(0);
50 FOR I=1 TO 100
60 PRINT #1,CHR$(201);
70 PRINT #1,CHR$(176);
80 PRINT #1,CHR$(9);
90 NEXT I
100 PRINT #1,CHR$(10);
110 CLOSE
120 END
```

Note:

- If in IBM mode, AGM must be set to ON.
- If you use ESC+ "[" + "g" +n₁+n₂+m in IBM Proprinter X24 mode, you must change line 40 as follows:

```
40 PRINT #1, CHR$(27)+"[" + "g" +CHR$(45)+CHR$(1)+CHR$(8);
```

Note:

- Bit Image Graphics prints unidirectionally for high precision printing. For high speed printing set the printer to bidirectional printing through the initial setup mode (see page 3-13).
- Graphics mode is released immediately following the printing of all bit image data. Printing will return to text mode.
- Bit image data is not affected by MSB control commands.

Alternate Graphic Mode (AGM)

There are two kinds of graphic printing in IBM Proprinter X24 mode. You can set them through Alternate Graphic Mode setting in the Initial Setup mode or through software.

5

When AGM is set to OFF, 8-pin bit image graphic is printed by using pins 1 through 20.

When Alternate Graphic Mode is set to ON, the printing of 8-pin Graphic mode is the same as in Epson LQ-850 mode. Also, graphic printing command, ESC+“*” in Epson LQ-850 mode is effective in this mode. Therefore, you can use the same command as in Epson LQ-850 mode.

The following table shows commands affected by AGM mode.

		AGM ON	AGM OFF
ESC+“K”+n ₁ +n ₂ ESC+“L”+n ₁ +n ₂ ESC+“Y”+n ₁ +n ₂ ESC+“Z”+n ₁ +n ₂		use 24 pin	use 20 pin
ESC+“[”+ “g”+n ₁ +n ₂	8-Pin mode	use 24 pin	use 20 pin
	24-Pin mode		use 24 pin
ESC+“3”+n ESC+“A”+n ESC+“J”+n		based on n/180 inch based on n/60 inch based on n/180 inch	based on n/216 inch based on n/72 inch based on n/216 inch

6. Epson LQ-850 Mode Commands

This chapter covers software commands of Epson LQ-850 mode. The software commands are grouped into the following classifications:

FONT SELECTION

Name	Function	Page
ESC+“x”+n	Selects print letter quality	6-6
ESC+“k”+n	Selects print font style	6-6
ESC+“S”+0	Selects superscript printing	6-7
ESC+“S”+1	Selects subscript printing	6-7
ESC+“T”	Releases sub/superscript printing	6-7

6

CHARACTER PITCH SELECTION

Name	Function	Page
ESC+“P”	Sets pica pitch (10 cpi) printing	6-7
ESC+“M”	*Sets elite pitch (12 cpi) printing	6-7
ESC+“g”	Sets micron (15 cpi) printing	6-8
SI	*Sets compressed (17 cpi) printing	6-8
ESC+SI	*Sets compressed (17 cpi) printing	6-8
DC2	Releases compressed printing	6-8
ESC+“p”+1	Sets proportional spacing	6-9
ESC+“p”+0	Releases proportional spacing	6-9
ESC+“l”+n	*Sets the pitches based on value of n	6-9

*When 12 cpi and compressed pitch are set simultaneously, subsequent output is printed in 20 cpi (up to 160 cpl).

CHARACTER HIGHLIGHT SELECTION

Name	Function	Page
ESC+“!”+n	Sets highlighting based on value of n	6-9
ESC+“E”	Sets emphasized printing	6-10
ESC+“F”	Releases emphasized printing	6-10
ESC+“w”+1	Sets double high printing	6-10
ESC+“w”+0	Releases double high printing	6-10
DC4	Releases single-line double wide printing	6-10
SO	Sets single-line double wide printing	6-10
ESC+SO	Sets single-line double wide printing	6-10
ESC+“W”+1	Sets double wide printing	6-11
ESC+“W”+0	Releases double wide printing	6-11

Epson LQ-850 Mode Commands

CHARACTER HIGHLIGHT SELECTION

Name	Function	Page
ESC+"G"	Sets double strike printing	6-11
ESC+"H"	Releases double strike printing	6-11
ESC+"-" +1	Sets underlining	6-11
ESC+"-" +0	Releases underlining	6-11
ESC+"("+"-" + n ₁ +n ₂ +m+d ₁ +d ₂	Select/Cancel the score	6-12

WORD PROCESSING MODE SELECTION

Name	Function	Page
ESC+"a"+0	Releases Word Processing mode	6-13
ESC+"a"+1	Selects centering mode	6-13
ESC+"a"+2	Selects right alignment mode	6-13
ESC+"a"+3	Selects justification mode	6-13
ESC+SP+n	Sets character dots spacing	6-13

6

CHARACTER SET SELECTION

Name	Function	Page
ESC+"4"	Sets Italic printing	6-13
ESC+"5"	Releases Italic printing	6-13
ESC+"R"+n	Sets international character set	6-14
ESC+"6"	Selects graphic character set 2	6-14
ESC+"7"	Selects graphic character set 1	6-14
ESC+"t"+n	Selects alternate character set	6-15

BIT IMAGE (GRAPHICS) MODE SELECTION

Name	Function	Page
ESC+"K"+n ₁ +n ₂	Sets 8 pin image standard density (60 dpi)	6-15
ESC+"L"+n ₁ +n ₂	Sets 8 pin image double density (120 dpi)	6-15
ESC+"Y"+n ₁ +n ₂	Sets 8 pin image double density double speed (120 dpi)	6-15
ESC+"Z"+n ₁ +n ₂	Sets 8 pin bit image quadruple density (240 dpi)	6-16
ESC+"*" +m+n ₁ +n ₂	Sets bit image mode selection (8 pin 60, 120, 120D, 240, 80, 90, 24 pin 60, 120, 90, 180, 360)	6-16
ESC+"?" +n+m	Reassigns graphics mode density	6-17

Epson LQ-850 Mode Commands

PAPER FEED SELECTION-Amount

Name	Function	Page
ESC+"0"	Sets paper feed to 1/8 inch (3.2 mm)	6-17
ESC+"2"	Sets paper feed to 1/6 inch (4.2 mm)	6-18
ESC+"A"+n	Sets paper feed to n/60 inch	6-18
ESC+"3"+n	Sets paper feed to n/180 inch	6-18
ESC+"+"n	Sets paper feed to n/360 inch	6-19

PAPER FEED SELECTION-Execution

Name	Function	Page
LF	Feeds paper one line	6-19
FF	Feeds paper to next top of form	6-20
ESC+"J"+n	Executes paper feed of n/180 inch for one line	6-20
ESC+"j"+n	Executes reverse paper feed of n/180 inch for one line	6-21

6

PAGE FORMAT CONTROL

Name	Function	Page
ESC+"C"+0+n	Sets page length in inches	6-21
ESC+"C"+n	Sets page length in lines	6-22
ESC+"I"+n	Sets left margin	6-22
ESC+"Q"+n	Sets right margin	6-23
ESC+"N"+n	Sets skip perforation	6-23
ESC+"O"	Releases skip perforation	6-23

TABULATION-Horizontal

Name	Function	Page
ESC+"D"+n ₁ +...+n _x +0	Sets horizontal tab	6-24
ESC+"D"+0	Releases horizontal tab	6-24
HT	Executes horizontal tab	6-24

Epson LQ-850 Mode Commands

TABULATION-Vertical

Name	Function	Page
ESC+"B"+n ₁ +...+n _x +0	Sets vertical tab	6-25
ESC+"B"+0	Releases vertical tab	6-25
VT	Executes vertical tab	6-25
ESC+"/"+n	Sets VFU channel	6-26
ESC+"b"+m+n ₁ +...+n _x +0	Sets VFU tabulation	6-26
ESC+"b"+m+0	Releases VFU tabulation	6-26

CARRIAGE CONTROL

Name	Function	Page
BS	Prints, then backspaces one character	6-27
CR	Prints a line, then returns carriage	6-27
ESC+"<"	Homes the printhead	6-27
ESC+"U"+1	Sets single direction printing	6-28
ESC+"U"+0	Releases single direction printing	6-28
ESC+"s"+1	Sets half speed printing	6-28
ESC+"s"+0	Releases half speed printing	6-28
ESC+"\")+n ₁ +n ₂	Moves the printhead to a relative horizontal position	6-28
ESC+"\$"+n ₁ +n ₂	Moves the printhead to an absolute horizontal position	6-29

6

DATA CONTROL

Name	Function	Page
CAN	Clears data in buffer	6-29
DC1	Selects printer remotely	6-29
DC3	Deselects printer remotely	6-29
DEL	Deletes last printable character	6-30
ESC+">"	Sets MSB on	6-30
ESC+"="	Sets MSB off	6-30
ESC+"#"	Cancels MSB setting	6-31

Epson LQ-850 Mode Commands

DOWNLOAD CHARACTER SELECTION

Name	Function	Page
ESC+"&" +0+n+m	Defines download font	6-31
ESC+"%" +0	Selects ROM CG	6-32
ESC+"%" +1	Selects download CG	6-32
ESC+":" +0+n+0	Copies internal ROM CG font into download CG	6-32

MISCELLANEOUS

Name	Function	Page
BEL	Sounds the buzzer	6-33
ESC	First byte of multi-byte control codes	6-33
NUL	Last byte of certain multi-byte control codes	6-33
ESC+"@"	Initializes the printer	6-34
ESC+"EM"+n	Cut Sheet Feeder control	6-34

Epson LQ-850 Mode Commands

LETTER QUALITY (LQ) FONT:

Selects letter quality font printing.

Name:	ESC	"x"	n	(n=0, 1)
Dec.:	27	120	n	
Hex.:	1B	78	n	

Comments:

- This command sets letter quality printing for the current pitch set through the Control Table or through software.
- The following values of n can be used.
 - n=1: LQ
 - n=0: Draft
- This command is operational only when the Font is set to "PROGRAM" on the Control Table (see page 3-3, 3-4).

6

FONT STYLE:

Selects font style.

Name:	ESC	"k"	n	(n=0, 2, 3, 4, 6)
Dec.:	27	107	n	
Hex.:	1B	6B	n	

Comments:

- The following values can be used.
 - n=0: Courier font
 - n=2: Courier font
 - n=3: Prestige font
 - n=4: Script font
 - n=6: Bold PS font
- This command is operational only when the Font is set to "PROGRAM" on Control Table (see the page 3-3, 3-4).
- This command is effective only in letter quality mode (ESC+"x"+1).

Epson LQ-850 Mode Commands

SUB/SUPERSCRIP FONT:

Selects sub/superscript font with characters printed in the bottom/top area of the line.

Name: Set: ESC "S" n Release: ESC "T"
(subscript: n=1/superscript: n=0)
Dec.: 27 83 n 27 84
Hex.: 1B 53 n 1B 54

Comments:

- Sub/superscript characters are 2/3 normal height.
- In PS mode, font and pitch are reduced to 2/3 their original width. In the other modes, font is reduced to 2/3 their original width and pitch is normal width. Refer to Appendix B.
- In draft mode, characters are normal width.

PICA PITCH:

Sets printing to 10 characters per inch (up to 80 characters per line).

Name: ESC "P"
Dec.: 27 80
Hex.: 1B 50

Comments:

- This command is operational only when the PITCH is set to "PROGRAM" on the Control Table (see page 3-3, 3-4).
- When pica and compressed are set simultaneously output is 17 cpi (up to 137 cpl).

ELITE PITCH:

Sets printing to 12 characters per inch (up to 96 characters per line).

Name: ESC "M"
Dec.: 27 77
Hex.: 1B 4D

Comments:

- This command is operational only when the PITCH is set to "PROGRAM" on the Control Table (see page 3-3, 3-4).
- When elite and compressed are set simultaneously output is 20 cpi (up to 160 cpl).

Epson LQ-850 Mode Commands

MICRON PITCH:

Sets printing to 15 characters per inch (up to 120 characters per line).

Name: ESC "g"
Dec.: 27 103
Hex.: 1B 67

Comments:

- The command is operational only when the PITCH is set to "PROGRAM" on the Control Table (see page 3-3, 3-4).
- When micron and compressed are set simultaneously output is 15 cpi (up to 120 cpl).

6

COMPRESSED PITCH:

Sets printing to 17 characters per inch (up to 137 characters per line).

Name: Set: SI or ESC SI Release: DC2
Dec.: 15 27 15 18
Hex.: 0F 1B 0F 12

Comments:

- This command is operational only when the PITCH is set to "PROGRAM" in the Control Table (see page 3-3, 3-4).
- When pica and compressed are set simultaneously output is 17 cpi (up to 137 cpl).
- When elite and compressed are set simultaneously output is 20 cpi (up to 160 cpl).
- When micron and compressed are set simultaneously output is 15 cpi (up to 120 cpl).
- When PS (Proportional Spacing) and compressed are set simultaneously output is compressed PS pitch.

Epson LQ-850 Mode Commands

PROPORTIONAL SPACING:

Sets proportional spacing between characters.

Name: Set: ESC "p" 1 Release: ESC "p" 0
Dec.: 27 112 1 27 112 0
Hex.: 1B 70 01 1B 70 00

Comments:

- If proportional spacing is set together with pica, elite or micron pitch, subsequent output is printed in proportional spacing. (Setting with compressed pitch is printed in compressed PS.)
- This command is operational only when the PITCH is set to "PROGRAM" on the Control Table (see page 3-3, 3-4).
- This command is ineffective when the font is set to "DRAFT" in the Control Table (see page 3-3, 3-4).

6

PROGRAMMABLE PITCH/HIGHLIGHTING:

Sets a combination of character pitch and/or highlighting.

Name: ESC "!" n (0 ≤ n ≤ 255)
Dec.: 27 33 n
Hex.: 1B 21 n

Comments:

- Print modes correspond to the setting of each bit as illustrated below.

bit	7 (msb)	6	5	4	3	2	1	0 (lsb)
1	Underlining	Italic	Double width	Double printing	Emphasized	Compressed	PS	Elite
0	Normal	Normal	Normal	Normal	Normal	Normal	Normal	Pica

- Bits 0,1 and 2 only pertain to pitch.
- If n=49 (31_{HEX}), bits 0, 4 and 5 are set to 1 producing double width, elite double printing.
- Pitch and highlight combinations are determined by the value of n.
- Compressed, pica, elite and proportional spacing pitch are operational only when the PITCH is set to "PROGRAM" on the Control Table (see page 3-3).
- Invalid values of n follow rules noted in individual commands.
- When elite and compressed are set simultaneously output is 20 cpi (up to 160 cpl).

6-9 Epson LQ-850 Mode Commands

Epson LQ-850 Mode Commands

EMPHASIZED PRINTING:

Sets printing to twice the original horizontal dot density.

Name:	Set:	ESC	"E"	Release:	ESC	"F"
Dec.:		27	69		27	70
Hex.:		1B	45		1B	46

Comment:

- Emphasized characters are printed at half speed (100 cps in draft pica pitch).

6

DOUBLE HIGH PRINTING:

Sets double high printing.

Name:	Set:	ESC	"w"	1	Release:	ESC	"w"	0
Dec.:		27	119	1		27	119	0
Hex.:		1B	77	01		1B	77	00

DOUBLE WIDE PRINTING-SINGLE LINE:

Sets double wide (elongated) character printing for one line only.

	Set:			Release:				
Name:	SO or	ESC	SO	DC4 or	ESC	"W"	0	
Dec.:	14	27	14	20	27	87	0	
Hex.:	0E	1B	0E	14	1B	57	00	

Comment:

- Single-line double wide printing is released when:
 - a LF, FF, or VT is executed.
 - the printer is initialized.
 - DC4 or ESC+"W"+0 is executed.
 - ESC+"!" +0 is executed.

Epson LQ-850 Mode Commands

DOUBLE WIDE PRINTING:

Sets double wide (elongated) character printing.

Name:	Set:	ESC	"W"	1	Release:	ESC	"W"	0
Dec.:		27	87	1		27	87	0
Hex.:		1B	57	01		1B	57	00

Comment:

- DC4 will not release the double wide printing set by ESC+ "W"+1.
-

DOUBLE STRIKE PRINTING:

Sets double strike printing:

Name:	Set:	ESC	"G"	Release:	ESC	"H"
Code:		27	71		27	72
Hex.:		1B	47		1B	48

Comment:

- Double Strike Printing prints each line of data with two passes of the printhead.
-

UNDERLINING:

Sets continuous underlining of characters.

Name:	Set:	ESC	"_"	1	Release:	ESC	"_"	0
Dec.:		27	45	1		27	45	0
Hex.:		1B	2D	01		1B	2D	00

Comments:

- Bit image data, spaces set by the HT code and IBM graphic characters are not underlined.
- Whenever two passes of the printhead are required, underline is printed only on the first pass.

Epson LQ-850 Mode Commands

SCORE:

Sets or cancel the scores.

Name:	ESC	"("	"_"	n ₁	n ₂	m	d ₁	d ₂
Dec.:	27	40	45	n ₁	n ₂	m	d ₁	d ₂
Hex.:	1B	28	2D	n ₁	n ₂	m	d ₁	d ₂

Comments:

- The value of n₁, n₂ and m must be as follows:
n₁=3, n₂=0 and m=1
- The value of d₁ selects the location of the score:
d₁=1: Underline
=2: Strikethrough
=3: Overscore
- The value of d₂ selects the line type as follows:
d₂=0 Cancel the score line selected by d₁
=1 Single continuous line
=2 Double continuous line
=5 Single broken line
=6 Double broken line
- Bits 0, 1 and 2 of d₂ determine the characteristics of the score line as shown below:

	Bit 2	Bit 1	Bit 0
On (1)	Broken line	Double line on	Single line on
Off (0)	Continuous line	Double line off	Single line off

Note:

•If Bit 1 and Bit 0 are both off, the selected score is cancelled. Double line and single line scores cannot be combined at the same score position.

Epson LQ-850 Mode Commands

WORD PROCESSING MODE SELECTION:

Selects word processing mode.

Name:	ESC	"a"	n	·	(n=0, 1, 2, 3)
Dec.:	27	97	n		
Hex.:	1B	61	n		

Comment:

- The following values can be used.
 - n=0: Releases word processing mode.
 - n=1: Selects centering mode.
 - n=2: Selects right alignment mode.
 - n=3: Selects justification mode.

6

CHARACTER DOT SPACING:

Sets character dot spacing until changed.

Name:	ESC	SP	n	(0 ≤ n ≤ 127)
Dec:	27	32	n	
Hex:	1B	20	n	

Comments:

- Sets the amount of dot space (Draft: n/120 inch, LQ: n/180 inch) added to the right of each character.
- This command allows microjustification.

ITALIC FONT:

Selects italic character printing.

Name:	Set:	ESC	"4"	Release:	ESC	"5"
Dec.:		27	52		27	53
Hex.:		1B	34		1B	35

Comment:

- Italic characters are printed in place of characters in locations 32_{DEC}~126_{DEC} (20_{HEX}~7E_{HEX}).

Epson LQ-850 Mode Commands

INTERNATIONAL CHARACTER SET:

Selects any one of the 13 international character sets or LEGAL character sets.

Name: ESC "R" n (0 ≤ n ≤ 12, or 64)
Dec.: 27 82 n
Hex.: 1B 52 n

Comments:

- Page A-7 identifies the characters generated by the appropriate codes.
- International character sets can be set in the Initial Setup mode (See page 3-20).

6

GRAPHIC CHARACTER SET I:

Selects graphic character set 1.

Name: ESC "7"
Dec.: 27 55
Hex.: 1B 37

Comments:

- Refer to Appendix A.
- This command is operational only when the graphic character set is selected by ESC+"t"+1.

GRAPHIC CHARACTER SET II:

Selects graphic character set 2.

Name: ESC "6"
Dec.: 27 54
Hex.: 1B 36

Comments:

- Refer to Appendix A.
- This command is operational only when the graphic character set is selected by ESC+"t"+1.

Epson LQ-850 Mode Commands

ALTERNATE CHARACTER SET:

Selects alternate character set.

Name:	ESC	"t"	n	(n=0, 1, 2)
Dec.:	27	116	n	
Hex.:	1B	74	n	

Comment:

- The following values of n can be used.
 - n=0: Italic
 - n=1: Graphic Character Set
 - n=2: Re-maps downloaded characters from 0_{DEC}~127_{DEC} to 128_{DEC}~255_{DEC}

6

8-PIN STANDARD DENSITY GRAPHICS:

Sets standard density graphics mode [60 dots per inch (25.4 mm)/480 dots per line]. (For detailed information, refer to Section 5.3.)

Name:	ESC	"K"	n ₁	n ₂	Data
Dec:	27	75	n ₁	n ₂	Data
Hex:	1B	4B	n ₁	n ₂	Data

8-PIN DOUBLE DENSITY GRAPHICS:

Sets double density graphics mode [120 dots per inch (25.4 mm)/960 dots per line]. (For detailed information, refer to Section 5.3.)

Name:	ESC	"L"	n ₁	n ₂	Data
Dec.	27	76	n ₁	n ₂	Data
Hex.:	1B	4C	n ₁	n ₂	Data

8-PIN DOUBLE SPEED/DOUBLE DENSITY GRAPHICS:

Sets double speed, double density graphics mode [120 dots per inch (25.4 mm)/960 dots per line]. (For detailed information, refer to Section 5.3.)

Name:	ESC	"Y"	n ₁	n ₂	Data
Dec.:	27	89	n ₁	n ₂	Data
Hex.:	1B	59	n ₁	n ₂	Data

Comment:

- Horizontally adjacent dots cannot be printed.

Epson LQ-850 Mode Commands

8-PIN QUADRUPLE DENSITY GRAPHICS:

Sets quadruple density graphics mode [240 dots per inch (25.4 mm)/3264 dots per line]. (For detailed information, refer to Section 5.3)

Name: ESC "Z" n₁ n₂ Data
Dec.: 27 90 n₁ n₂ Data
Hex.: 1B 5A n₁ n₂ Data

Comment:

- Horizontally adjacent dots cannot be printed.

BIT IMAGE MODE SELECTION:

Selects one of the 8-pin or 24-pin bit image graphic modes. (For detailed information, refer to Section 5.3)

Name: ESC "*" m n₁ n₂ Data
(m=0,1,2,3,4,6,32,33,38,39,40)
Dec.: 27 42 m n₁ n₂ Data
Hex.: 1B 2A m n₁ n₂ Data

Comments:

- The following table illustrates the various modes based upon the values of m.

m	pin	Dots/Inch	Dots/Line	
0	8	60	480	Standard Density
1	8	120	960	Double Density
2	8	120	960	Double Speed, Double Density
3	8	240	1920	Quadruple Density
4	8	80	640	CRT I
6	8	90	720	CRT II
32	24	60	480	Standard Density
33	24	120	960	Double Density
38	24	90	720	CRT III
39	24	180	1440	Triple Density
40	24	360	2880	Hex Density

- When m=2,3,40, Horizontal adjacent dots cannot be printed.

Epson LQ-850 Mode Commands

BIT IMAGE MODE REASSIGNMENT:

Reassigns bit image graphics mode density.

Name:	ESC	"?"	n	m
			(n=75,76,89,90	m=0,1,2,3,4,6,32,33,38,39,40)
Dec.:	27	63	n	m
Hex.:	1B	3F	n	m

Comments:

- The value of n specifies the graphics mode which is to be re-assigned:

n=75: Reassign Standard Density (ESC+"K"+n₁+n₂)

n=76: Reassign Double Density (ESC+"L"+n₁+n₂)

n=89: Reassign Double Speed, Double Density (ESC+"Y"+n₁+n₂)

n=90: Reassign Quadruple Density (ESC+"Z"+n₁+n₂)

- The value of m specifies the graphics mode to which the original is to be reassigned. Refer to Table 5.1 on page 5-15.

1/8 INCH PAPER FEED:

Sets paper feed amount to 1/8 inch (3.2 mm).

Name:	ESC	"0"
Dec.:	27	48
Hex.:	1B	30

Epson LQ-850 Mode Commands

1/6 INCH PAPER FEED:

Sets paper feed amount to 1/6 inch (4.2 mm).

Name: ESC "2"
Dec.: 27 50
Hex.: 1B 32

n/60 INCH PAPER FEED:

Sets programmable paper feed amount to n/60 inch.

Name: ESC "A" n
Dec.: 27 65 n
Hex.: 1B 41 n

6

Comment:

•n/60 inch paper feed is valid for $0 \leq n \leq 127$.

n/180 INCH PAPER FEED:

Sets programmable paper feed amount to n/180 inch.

Name: ESC "3" n
Dec.: 27 51 n
Hex.: 1B 33 n

Comment:

•n/180 inch paper feed is valid for $0 \leq n \leq 255$.

Epson LQ-850 Mode Commands

n/360 INCH PAPER FEED:

Sets programmable paper feed amount to n/360 inch.

Name:	ESC	“+”	n
Dec.:	27	43	n
Hex.:	1B	2B	n

Comment:

•n/360 inch paper feed is valid for $0 \leq n \leq 255$.

6

LINE FEED (LF):

Causes data in buffer to be printed and then executes single line feed.

Name:	LF
DEC.:	10
Hex.:	0A

Comments:

- When the new line position falls within the perforation skip area, the paper advances to the next top of form position if skip over perforation is turned on.
- If there is no data, “space” data (ASCII 32), or blanks between HT print positions in the buffer, LF feeds the paper 1 line.
- LF code releases single-line double width printing set by SO or ESC+SO.
- The amount of line feed depends upon the lines per inch set by the line feed amount command.

Epson LQ-850 Mode Commands

FORM FEED (FF):

Feeds paper to next top of form position after printing data in the buffer.

Name: FF
Dec.: 12
Hex.: 0C

Comments:

- FF releases single-line double width printing set by SO or ESC+SO.
- Amount of form feed depends upon the page length set by the page length control command or the EZ Set Operator Panel.

6

n/180 INCH PAPER FEED:

Prints out the data in the print buffer and feeds the paper n/180 inch.

Name: ESC "J" n
Dec.: 27 74 n
Hex.: 1B 4A n

Comments:

- Single-line, n/180 inch paper feed is valid for $0 \leq n \leq 255$.
- This command sets the paper feed for ONE line only. The carriage does not return to the left margin position. Instead, printing of the next line begins where previous printing left off.
- This command does not release single-line double wide printing set by SO or ESC+SO.

Epson LQ-850 Mode Commands

n/180 INCH REVERSE DIRECTION SINGLE LINE PAPER FEED:

Prints out the data in the print buffer and feeds the paper n/180 inch in reverse direction.

Name:	ESC	“j”	n
Dec.:	27	106	n
Hex.:	1B	6A	n

Comments:

- Reverse, single line n/180inch paper feed is valid for $0 \leq n \leq 255$.
- This command sets reverse direction paper feed for one line only. The carriage will not return to the left margin position. Instead, the printing of the next line begins where the previous printing left off.
- This command does not release single-line double width printing set by SO or ESC+SO.

Note:

- Reverse paper feed cannot be executed in the area within 3.6 inches (91.4 mm) of the bottom perforation. Additionally, the perforation should not be included in the area of reverse paper feed.
- Multi-part forms or pull tractor feed paper should not be used with reverse paper feed.

6

PAGE LENGTH (INCHES):

Sets page length in inches.

Name:	ESC	“C”	0	n
Dec.:	27	67	0	n
Hex.:	1B	43	00	n

Comments:

- Upon receipt of ESC+“C”+0+n, the present line position becomes the top of page position.
- The value of n must be in the range $0 \leq n \leq 22$.
- ESC+“C”+0+n releases the skip perforation settings.
- The page length does not change even if the paper feed amount is changed.
- The terms “form” and “page” are interchangeable.

Epson LQ-850 Mode Commands

PAGE LENGTH (LINES):

Sets page length in number of lines.

Name:	ESC	"C"	n
Dec.:	27	67	n
Hex.:	1B	43	n

Comments:

- Upon receipt of ESC+"C"+n, the present line position becomes the top of page position.
- The value of n must be in the range $1 \leq n \leq 127$. If n=0, page length returns to the inch designation.
- ESC+"C"+n releases the skip perforation settings.
- The page length does not change even if the paper feed amount is changed.
- The terms "form" and "page" are interchangeable.

6

LEFT MARGIN:

Sets position of left margin.

Name:	ESC	"I"	n
Dec.:	27	108	n
Hex.:	1B	6C	n

Comments:

- If the value of n exceeds the right margin value, ESC+"I"+n is ineffective and the left margin does not change.
- Setting the left margin position clears all data in the print buffer.
- In proportional spacing, the value of n is based on 10 cpi.
- Once the left margin position is set, a change in the character mode will not alter this left margin setting.
- Permissible values of n are given below.

PICA	$0 \leq n \leq 78$
ELITE	$0 \leq n \leq 93$
MICRON	$0 \leq n \leq 117$
COMPRESSED	$0 \leq n \leq 133$

Epson LQ-850 Mode Commands

RIGHT MARGIN:

Sets position of right margin.

Name: ESC "Q" n
Dec.: 27 81 n
Hex.: 1B 51 n

Comments:

- Permissible values of n are given below.

PICA	$2 \leq n \leq 80$
ELITE	$3 \leq n \leq 96$
MICRON	$3 \leq n \leq 120$
COMPRESSED	$4 \leq n \leq 137$

- If the value of n exceeds the left margin value, ESC+"Q"+n is ignored.
- Setting the right margin clears all data in the buffer.
- In proportional spacing, the value of n is based on 10 cpi.
- Once the right margin position is set, a change in the character mode will not alter this right margin setting.

SKIP PERFORATION:

Sets skip perforation.

Name: Set: ESC "N" n Release: ESC "O"
Dec.: 27 78 n 27 79
Hex.: 1B 4E n 1B 4F

Comments:

- The value of n specifies the number of lines (or n times the current line spacing amount) to be skipped at the bottom of the page.
- This command is effective only for $1 \leq n \leq 127$. If $n > 128$, the value is processed as $n - 128$, if $n = 128$ the command is ignored.
- The skip perforation amount does not change even if the paper feed amount is changed following a skip perforation designation.
- The skip perforation setting is released upon receipt of the page length designation command.
- If skip perforation is set to ON in the Initial Setup mode, the skip perforation amount is set to 1 inch (25.4 mm) unless changed by this command. If skip perforation is set to OFF in the Initial Setup mode, skip perforation is not executed unless specified by ESC+"N"+n.
- ESC+"O" will override the skip perforation setting established when skip perforation is set to ON in the Initial Setup mode.

Epson LQ-850 Mode Commands

HORIZONTAL TAB STOP SETTING:

Sets horizontal tabulations to specified values:

	Set:				Release:		
Name:	ESC	"D"	n ₁ ...n _x	0	ESC	"D"	0
Dec.:	27	68	n ₁ ...n _x	0	27	68	0
Hex.:	1B	44	n ₁ ...n _x	00	1B	44	00

Comments:

- Horizontal tabs are set from the left margin position.
- Horizontal tabs must be designated such that $n_1 < n_2 < \dots < n_x$.
- A maximum of 32 tabs may be set on a single line.
- ESC+"D"+n₁+n₂+...+n_x+0 sets horizontal tab stops. The HT command executes the tab designation.
- In proportional spacing, horizontal tabs are set based on 10 cpi.
- When the left margin is changed, horizontal tabs will be moved based on new margin setting.
- When the printer is powered up, TAB is automatically set every 8 characters.
- If the pitch is altered after designation of horizontal tabs, the tab positions do not move.

6

HORIZONTAL TAB EXECUTION:

Executes the horizontal TAB as designated by ESC+"D"+n₁+n₂+...+n_x+0.

Name:	HT
Dec.:	9
Hex.:	09

Comments:

- If the value of the horizontal TAB is less than the present column position, then HT is ignored.
- When in underline mode, the blank spaces between consecutive HT print position are not underlined.

Epson LQ-850 Mode Commands

VERTICAL TAB STOP SETTING:

Sets vertical tabulation to specified values.

	Set:				Release:			
Name:	ESC	"B"	$n_1\dots n_x$	0	ESC	"B"	0	
Dec.:	27	66	$n_1\dots n_x$	0	27	66	0	
Hex.:	1B	42	$n_1\dots n_x$	00	1B	42	00	

Comments:

- VT is set from the top of page position.
- Vertical tabs must be designated such that $n_1 < n_2 < \dots < n_x$.
- A maximum of 16 tabs may be set.
- ESC+"B"+ $n_1+n_2+\dots+n_x+0$ sets vertical tab stops. The VT command executes the tab designation.
- If the paper feed amount is changed after a designation of vertical tabs, tab positions do not change.
- VT setting is also released by page length designation commands.

6

VERTICAL TAB EXECUTION:

Executes the vertical TAB as designated by ESC+"B"+ $n_1+n_2+\dots+n_x+0$, ESC+"b"+ $m+n_1+n_2+\dots+n_x+0$.

Name:	VT
Dec.:	11
Hex.:	0B

Comments:

- When TABs are set with VT or VFU setting command and when there is no tab setting on a position exceeding the present line, data is printed out and paper is fed to the next top of page position (same as FF).
- On power up no vertical tabs have been set, therefore when a VT is sent the paper advances one line.
- When vertical TAB is cleared by ESC+"B"+0, execution of VT causes data in the buffer to be printed and does not advance the paper.

Epson LQ-850 Mode Commands

VFU CHANNEL SELECTION:

Selects one of eight channels in the Vertical Format Unit (VFU).

Name:	ESC	"/"	n	($0 \leq n \leq 7$)
Dec.:	27	47	n	
Hex.:	1B	2F	n	

Comments:

- The value of n must be in the range $0 \leq n \leq 7$ and selects one of eight channels (0~7).
- Channel 0 is the default setting.

6

VFU SETTING:

Sets the tab position of any channel in the VFU (Vertical Format Unit).

	Set:				Release:			
Name:	ESC	"b"	m	$n_1...n_x$ 0	ESC	"b"	m	0
				($0 \leq m \leq 7, 1 \leq x \leq 16$)				
Dec.:	27	98	m	$n_1...n_x$ 0	27	98	m	0
Hex.:	1B	62	m	$n_1...n_x$ 00	1B	62	m	00

Comments:

- The VFU has 8 channels. A maximum of 16 vertical tabs can be set by each channel.
- The VFU is valid for $0 \leq m \leq 7$ and selects one channel based on the value of m.
- Any VFU setting exceeding the page length is ineffective.
- To operate the VFU, input the VT code (11 DEC) after selecting the channel via channel selection command (ESC+ "/" + n).
- The VFU position does not change even if paper feed amount is altered after VFU setting.
- The vertical tab specified with ESC+"B"+ $n_1+n_2+...+n_x+0$ is set to VFU channel 0.
- The VFU setting is also released by the page length designation commands.

Epson LQ-850 Mode Commands

BACKSPACE:

Prints data in buffer and backspaces one space.

Name: BS
Dec.: 8
Hex.: 08

Comments:

- Since BS backspaces the width of a character, the backspacing amount will depend upon the pitch set when the BS code is executed.
- This command is ignored in the word processing mode (ESC+“a”+1, ESC+“a”+2 or ESC+“a”+3).

6

CARRIAGE RETURN:

Prints all data in buffer and designates that the next line starts at the left margin.

Name: CR
Dec.: 13
Hex.: 0D

Comments:

- Certain computers issue an automatic line feed with a carriage return. Check your computer manual for details.
- When automatic LF is set to ON in the Initial Setup mode (see page 3-13), the paper is fed automatically (a LF is executed automatically) whenever a CR code is executed.

HOME PRINTHEAD:

Causes printhead to return to its home position.

Name: ESC “<”
Dec.: 27 60
Hex.: 1B 3C

Epson LQ-850 Mode Commands

SINGLE DIRECTION:

Sets single direction (left to right) printing mode.

Name:	Set:	ESC	"U"	1	Release:	ESC	"U"	0
Dec.:		27	85	1		27	85	0
Hex.:		1B	55	01		1B	55	00

HALF SPEED PRINTING:

Sets printing to half speed.

Name:	Set:	ESC	"s"	1	Release:	ESC	"s"	0
Dec.:		27	115	1		27	115	0
Hex.:		1B	73	01		1B	73	00

6

Comment:

- Half speed printing can be set only in the draft pica, draft elite, standard density image, double speed double density image, CRT I image and CRT II image modes.

RELATIVE HORIZONTAL POSITION:

Moves the printhead to a relative horizontal position.

Name:	ESC	"V"	n ₁	n ₂
Dec.:	27	92	n ₁	n ₂
Hex.:	1B	5C	n ₁	n ₂

Comments:

- This command moves the printhead $(n_1+256 \times n_2)/120$ inch in draft, or $(n_1+256 \times n_2)/180$ inch in LQ from current position at which point printing of subsequent data will start.
- The printhead can be moved to the right or left.
To move m dots to right: $n_1=m \bmod 256$, $n_2=\text{INT}(m/256)$
To move m dots to left: $n_1=(65536-m)-n_2 \times 256$,
 $n_2=\text{INT}[(65536-m)/256]$

Epson LQ-850 Mode Commands

ABSOLUTE HORIZONTAL POSITION:

Moves the printhead to an absolute horizontal position.

Name:	ESC	"\$"	n_1	n_2
Dec.:	27	36	n_1	n_2
Hex.:	1B	24	n_1	n_2

Comment:

- This command moves the printhead to a position $n_1 + 256 \times n_2$ dots (units) from the left margin. Each unit equals 1/60th of an inch.
-

CANCEL:

Clears all data in the buffer.

6

Name:	CAN
Dec.:	24
Hex.:	18

REMOTE PRINTER SELECT:

Selects the printer remotely, enabling it to receive data.

Name:	DC1	(Device Control 1)
Dec.:	17	
Hex.:	11	

Comments:

- Receipt of DC1 while the printer is deselected by DC3 enables the printer to receive data.
 - The printer buffer data previously received between DC3 and DC1 is lost.
-

REMOTE PRINTER DESELECT:

Deselects the printer remotely, disabling it from receiving data.

Name:	DC3	(Device Control 3)
Dec.:	19	
Hex.:	13	

Comment:

- All data sent in deselect status become invalid. In order to return to select status, send DC1 code.

DELETE:

Deletes the last character stored in the buffer.

Name: DEL
Dec.: 127
Hex.: 7F

Comments:

- Only ordinary text may be DELETED. Bit image data, spacing between output generated by consecutive TABs, and commands cannot be DELETED.
- This command is ignored in the word processing mode (ESC+"a"+1, ESC+"a"+2 or ESC+"a"+3).

MSB ON:

Sets the Most Significant Bit to 1.

Name: ESC ">"
Dec.: 27 62
Hex.: 1B 3E

Comments:

- ESC+">" has no effect on bit image data.
- This setting can be released by ESC+"#".

MSB OFF:

Sets the Most Significant Bit to 0.

Name: ESC "=""
Dec.: 27 61
Hex.: 1B 3D

Comments:

- ESC+"="" has no effect on bit image data.
- This setting can be released by ESC+"#".

Epson LQ-850 Mode Commands

CANCELS MSB SETTING:

Sets printer to receive 8th bit "as is".

Name:	ESC	"#"
Dec.:	27	35
Hex.:	1B	23

Comments:

- This setting has no effect on bit image data.
- This setting cannot be affected by data length setting in the Initial Setup mode.

6

FONT DOWNLOADING:

Defines downloadable characters into specified address locations in RAM (see Section 5.2).

Name:	ESC	"&"	0	n	m	d ₀	d ₁	d ₂	P ₁ ...P _x
Dec.:	27	38	0	n	m	d ₀	d ₁	d ₂	P ₁ ...P _x
Hex.:	1B	26	00	n	m	d ₀	d ₁	d ₂	P ₁ ...P _x

Comments:

- The values n and m are the ASCII address locations of the first and last characters being defined.
- The values of d₀, d₁ and d₂ define the character cell.

d₀=Left Space

d₁=Body

d₂=Right Space

- The values of d₀, d₁ and d₂ vary with pitch as follows:

	d ₁	d ₀ +d ₁ +d ₂ (total)
Draft	9	12
LQ 10 cpi	29	36
LQ 12 cpi	23	30
LQ 15 cpi	15	24
PS	37	42

Note:

In PS, values of d₁ and d₀+d₁+d₂ are at the maximum allowable width.

Epson LQ-850 Mode Commands

SELECTS ROM CG OR DOWNLOADED CG:

(See Section 5.2)

Name:	ESC	"%"	n	(n=0,1)
Dec.:	27	37	n	
Hex.:	1B	25	n	

Comment:

- The following values of n can be used.
n=0: Select ROM CG
n=1: Select downloaded CG

6

ROM CHARACTER GENERATION SET COPY:

Copies internal ROM CG font into downloadable font area.

Name:	ESC	“.”	0	n	0
Dec.:	27	58	0	n	0
Hex.:	1B	3A	00	n	00

Comments:

- The following values can be used.
n=0: Courier font
n=2: Courier font
n=3: Prestige font
n=4: Script font
n=6: Bold PS font
- All ROM CG font in draft and LQ modes are copied to the downloadable font area.
- Upon receipt of the command, all previous downloaded fonts will be changed to ROM CG font.
- When altering only part of the ROM CG, use this command before font downloading.

Epson LQ-850 Mode Commands

BELL:

Sounds buzzer for approximately 0.5 second.

Name: BEL
Dec.: 7
Hex.: 07

ESCAPE:

First byte of each multi-byte printer control code.

6

Name: ESC
Dec.: 27
Hex.: 1B

Comment:

- Cannot be generated by the ESC key on certain computers.
-

NULL:

Last byte of certain multi-byte printer control codes.

Name: NUL
Dec.: 0
Hex.: 00

Epson LQ-850 Mode Commands

RESET PRINTER:

Initializes printer, causing data in the print buffer, but not in the receive buffer, to be cleared.

Name: ESC “@”
Dec.: 27 64
Hex.: 1B 40

Comment:

- Refer to Section 3.6 on page 3-26 for an explanation of printer initialization.

6

SELECTS CSF:

Selects Cut Sheet Feeder(CSF) mode ON/OFF.

Name. ESC EM n
Dec.: 27 25 n
Hex.: 1B 19 n

Comment:

- The following values of n can be used.
 - n=82 or “R”: Eject and Load a sheet
 - n=0: Cut Sheet Feeder mode is OFF
 - n=4: Cut Sheet Feeder mode is ON

Note:

If the Cut Sheet Feeder mode is set to ON without installing the CSF, the paper will not feed correctly.

7. IBM Proprinter X24 Mode Commands

This chapter covers software commands of IBM Proprinter X24 mode.

The software commands are grouped into the following classifications:

FONT SELECTION

Name	Function	Page
ESC+"I"+n	Selects print mode	7-5
ESC+"k"+n	Selects print font style	7-6
ESC+"S"+0	Selects superscript printing	7-6
ESC+"S"+1	Selects subscript printing	7-6
ESC+"T"	Releases sub/superscript printing	7-6

CHARACTER PITCH SELECTION

Name	Function	Page
ESC+";"	Sets elite pitch (12 cpi) printing	7-7
SI	Sets compressed (17 cpi) printing	7-7
ESC+SI	Sets compressed (17 cpi) printing	7-7
DC2	Releases elite and compressed printing	7-7
ESC+"P"+1	Sets proportional spacing	7-7
ESC+"P"+0	Releases proportional spacing	7-7

7

CHARACTER HIGHLIGHT SELECTION

Name	Function	Page
ESC+"E"	Sets emphasized printing	7-8
ESC+"F"	Releases emphasized printing	7-8
ESC+"G"	Sets double strike printing	7-8
ESC+"H"	Releases double strike printing	7-8
DC4	Releases single-line double wide printing	7-8
SO	Sets single-line double wide printing	7-8
ESC+SO	Sets single-line double wide printing	7-8
ESC+"W"+1	Sets double wide printing	7-9
ESC+"W"+0	Releases double wide printing	7-9
ESC+"["+"@"+n ₁ +n ₂ +m ₁ +m ₂ +m ₃ +m ₄	Selects double high & double wide printing	7-9
ESC+"~"+1	Sets underlining	7-10
ESC+"~"+0	Releases underlining	7-10
ESC+"_" +1	Sets overlining	7-10
ESC+"_" +0	Releases overlining	7-10

IBM Proprinter X24 Mode Commands

CHARACTER SET SELECTION

Name	Function	Page
ESC+"7"	Sets alternate character set 1	7-10
ESC+"6"	Sets alternate character set 2	7-11

BIT IMAGE (GRAPHICS) MODE SELECTION

Name	Function	Page
ESC+"K"+n ₁ +n ₂	Sets 8-pin image standard density (60 dpi)	7-11
ESC+"L"+n ₁ +n ₂	Sets 8-pin image double density (120 dpi)	7-11
ESC+"Y"+n ₁ +n ₂	Sets 8-pin image double density/ double speed (120 dpi)	7-11
ESC+"Z"+n ₁ +n ₂	Sets 8-pin image quadruple density (240 dpi)	7-12
ESC+"*" +m+n ₁ +n ₂ (AGM only)	Sets bit image mode selection (8-pin 60, 80, 90, 120, 120D, 240) (24-pin 60, 90, 120, 180, 240, 360)	7-12
ESC+"["+"g"+n ₁ +n ₂ +m	Sets bit image mode selection (8-pin 60, 120, 120D, 240) (24-pin 60, 120, 180, 360)	7-13

PAPER FEED SELECTION-Amount

Name	Function	Page
ESC+"0"	Sets paper feed to 1/8 inch (3.2 mm)	7-13
ESC+"1"	Sets paper feed to 7/72 inch (2.5 mm)	7-14
ESC+"2"	Executes line spacing set by ESC+"A"+n	7-14
ESC+"A"+n	Sets paper feed to n/72 inch or n/60 inch	7-14
ESC+"3"+n	Sets paper feed to n/216 inch or n/180 inch	7-15
ESC+"["+"N"+n ₁ +n ₂ +n ₃ +n ₄ +n ₅ +n ₆	Selects the base line feed unit for ESC+"3" and ESC+"J", ESC+"A"+n	7-15
ESC+"5"+1	Set automatic line feed	7-16
ESC+"5"+0	Releases automatic line feed	7-16

IBM Proprinter X24 Mode Commands

PAPER FEED SELECTION-Execution

Name	Function	Page
LF	Feeds paper one line	7-16
FF	Feeds paper to next top of form	7-17
ESC+"J"+n	Executes one-line paper feed of n/216 inch or n/180 inch	7-17

PAGE FORMAT CONTROL

Name	Function	Page
ESC+"C"+0+n	Sets page length in inches	7-18
ESC+"C"+n	Sets page length in lines	7-18
ESC+"X"+n ₁ +n ₂	Sets left and right margin	7-19
ESC+"N"+n	Sets skip perforation	7-19
ESC+"O"	Releases skip perforation	7-19
ESC+"4"	Sets top of form	7-20

7

TABULATION-Horizontal

Name	Function	Page
ESC+"D"+n ₁ +...+ n _x +0	Sets horizontal tab	7-20
ESC+"D"+0	Releases horizontal tab	7-20
HT	Executes horizontal tab	7-21

TABULATION-Vertical

Name	Function	Page
ESC+"B"+n ₁ +...+ n _x +0	Sets vertical tab	7-21
ESC+"B"+0	Releases vertical tab	7-21
VT	Executes vertical tab	7-22
ESC+"R"	Returns to default tabs	7-22

IBM Proprinter X24 Mode Commands

CARRIAGE CONTROL

Name	Function	Page
BS	Prints, then backspaces one character	7-23
CR	Prints a line, then returns carriage	7-23
ESC+"U"+1	Sets single direction printing	7-23
ESC+"U"+0	Releases single direction printing	7-23
ESC+"d"+n ₁ +n ₂	Moves the printhead to a relative horizontal position	7-24

DATA CONTROL

Name	Function	Page
CAN	Clears data in buffer	7-24
DC1	Selects printer remotely	7-24
ESC+"Q"+36	Deselects printer remotely	7-25

DOWNLOAD CHARACTER SELECTION

Name	Function	Page
ESC+"="n ₁ +n ₂ + 35+A ₁ +A ₂	Defines download font	7-25

7

MISCELLANEOUS

Name	Function	Page
BEL	Sounds the buzzer	7-25
ESC	First byte of multi-byte control codes	7-26
NUL	Last byte of certain multi-byte control codes	7-26
ESC+"\"n ₁ +n ₂	Prints continuously from all character chart	7-26
ESC+"^"	Prints one character from all character chart	7-27
ESC+"j"	Sets OFF LINE mode	7-27

IBM Proprinter X24 Mode Commands

PRINT MODE SELECT:

Selects the font and print quality.

Name:	ESC	"I"	n
Dec.:	27	73	n
Hex.:	1B	49	n

Comments:

- The following values of n can be used:

n= 0:	Internal characters Draft 10 cpi font
n= 2:	Internal characters LQ 10 cpi font
n= 3:	Internal characters Proportional LQ font
n= 4:	Download characters Draft 10 cpi font
n= 6:	Download characters LQ 10 cpi font
n= 7:	Download characters Proportional LQ font
n= 8:	Internal characters Draft 12 cpi font
n=10:	Internal characters LQ 12cpi font
n=12:	Download characters Draft 12 cpi font
n=14:	Download characters LQ 12 cpi font
n=16:	Internal characters Draft 17 cpi font
n=18:	Internal characters LQ 17 cpi font
n=20:	Download characters Draft 17 cpi font
n=22:	Download characters LQ 17 cpi font

- This command is operational only when FONT and PITCH are set to "PROGRAM" on the Control Table. (see page 3-3,3-4)

7

IBM Proprinter X24 Mode Commands

FONT STYLE:

Selects font style.

Name:	ESC	"k"	n	(n=0, 2, 3, 4, 6)
Dec.:	27	107	n	
Hex.:	1B	6B	n	

Comments:

- The following values can be used.

n=0:	Courier font
n=2:	Courier font
n=3:	Prestige font
n=4:	Script font
n=6:	Bold PS font

- IBM characters in locations 0~31_{DEC} (except 19, 20, 21_{DEC}) [00~1F_{HEX} (except 13, 14, 15_{HEX})] and 250~255_{DEC} (F0~FF_{HEX}) are printed in Courier font, regardless of font selection.
- This command is operational only when the Font is set to "PROGRAM" on Control Table.

7

SUB/SUPERSCRIP FONT:

Selects sub/superscript font with characters printed in the bottom/top area of the line.

Name:	Set:	ESC	"S"	n	Release:	ESC	"T"
	(Subscript: n=1/Superscript: n=0)						
Dec.:		27	83	n		27	84
Hex.:		1B	53	n		1B	54

Comments:

- Sub/superscript characters are 2/3 normal height.
- Sub/superscript characters can be printed in the letter quality or draft mode.
- Sub/superscript characters are normal width.

IBM Proprinter X24 Mode Commands

ELITE PITCH:

Sets printing to 12 characters per inch (up to 96 characters per line).

Name:	Set:	ESC	“:”	Release:	DC2
Dec.:		27	58		18
Hex.:		1B	3A		12

Comment:

- This command is operational only when the PITCH is set to “PROGRAM” on the Control Table (see page 3-3, 3-4).
-

COMPRESSED PITCH:

Sets printing to 17 characters per inch (up to 137 characters per line).

Name:	Set:	SI	or	ESC	SI	Release:	DC2
Dec.:		15		27	15		18
Hex.:		0F		1B	0F		12

Comment:

- This command is operational only when the PITCH is set to “PROGRAM” on the Control Table (see page 3-3, 3-4).
-

PROPORTIONAL SPACING:

Sets proportional spacing between characters.

Name:	Set:	ESC	“P”	1	Release:	ESC	“P”	0
Dec.:		27	80	1		27	80	0
Hex.:		1B	50	01		1B	50	00

Comments:

- This command is operational only when the PITCH is set to “PROGRAM” on the Control Table.
- This command is ineffective when the FONT is set to Draft on the Control Table (see page 3-3, 3-4).

IBM Proprinter X24 Mode Commands

EMPHASIZED PRINTING:

Sets printing to twice the original horizontal dot density.

Name:	Set:	ESC	"E"	Release:	ESC	"F"
Dec.:		27	69		27	70
Hex.:		1B	45		1B	46

Comments:

- Emphasized characters are printed at half speed (100 cps in draft pica pitch).

DOUBLE STRIKE PRINTING:

Sets double strike character printing.

Name:	Set:	ESC	"G"	Release:	ESC	"H"
Dec.:		27	71		27	72
Hex.:		1B	47		1B	48

7

DOUBLE WIDE PRINTING-SINGLE LINE:

Sets double wide (elongated) character printing for one line only.

	Set:			Release:				
Name:	SO	or	ESC	SO	DC4	or	ESC	"W" 0
Dec.:	14		27	14	20		27	87 0
Hex.:	0E		1B	0E	14		1B	57 00

Comment:

- Single-line double wide printing is released when:
 - a LF, FF, or VT is executed.
 - a CR is executed.
 - DC4 or ESC+"W"+0 is executed.

IBM Proprinter X24 Mode Commands

DOUBLE WIDE PRINTING:

Sets double wide (elongated) character printing.

Name:	Set:	ESC	"W"	1	Release:	ESC	"W"	0
Dec.:		27	87	1		27	87	0
Hex.:		1B	57	01		1B	57	00

Comment:

- Double wide printing set by ESC+"W"+1 is only released by ESC+"W"+0.

DOUBLE HIGH AND DOUBLE WIDE PRINTING:

Sets printing to double high, double wide, or both at the same time.

7

Name:	ESC	"["	"@"	n ₁	n ₂	m ₁	m ₂	m ₃	m ₄
Dec.:	27	91	64	n ₁	n ₂	m ₁	m ₂	m ₃	m ₄
Hex.:	1B	5B	40	n ₁	n ₂	m ₁	m ₂	m ₃	m ₄

Comments:

- The value of n₁, n₂, m₁ and m₂ must be used as follows:
n₁=4, n₂=0, m₁=0, m₂=0
- The value of m₃ selects both the line feed and character height as follows:

m ₃	Function	
	Line feed	Character height
0	Unchanged	
1	Unchanged	Single-line
2	Unchanged	Double-high
16	Single	Unchanged
17	Single	Single-high
18	Single	Double-high
32	Double	Unchanged
33	Double	Single-high
34	Double	Double-high

- The value of m₄ selects the character width as follows:
m₄=1: Single-width
m₄=2: Double-width

IBM Proprinter X24 Mode Commands

UNDERLINING:

Sets continuous underlining of characters.

Name:	Set:	ESC	"_"	1	Release:	ESC	"_"	0
Dec.:		27	45	1		27	45	0
Hex.:		1B	2D	01		1B	2D	00

Comments:

- Bit image data, spaces set by the HT code and IBM Graphic characters are not underlined.
 - Pin No. 24 of the printhead is used for underlining.
-

OVERLINING:

Sets continuous overlining of characters.

Name:	Set:	ESC	"_"	1	Release:	ESC	"_"	0
Dec.:		27	95	1		27	95	0
Hex.:		1B	5F	01		1B	5F	00

Comments:

- Bit image data, spaces set by the HT code and IBM Graphic characters are not overlined.
 - Pin No. 1 of the printhead is used for overlining.
-

IBM CHARACTER SET I:

Selects IBM Proprinter X24 character set 1.

Name:	ESC	"7"
Dec.:	27	55
Hex.:	1B	37

Comment:

- Refer to Appendix A.

IBM Proprinter X24 Mode Commands

IBM CHARACTER SET II:

Selects IBM Proprinter X24 character set 2.

Name: ESC "6"
Dec.: 27 54
Hex.: 1B 36

Comment:

- Refer to Appendix A.

8-PIN STANDARD DENSITY GRAPHICS:

Sets standard density graphics mode [60 dots per inch(25.4 mm) /480 dots per line].

Name: ESC "K" n₁ n₂ Data
Dec.: 27 75 n₁ n₂ Data
Hex.: 1B 4B n₁ n₂ Data

(See Section 5.3)

8-PIN DOUBLE DENSITY GRAPHICS:

Sets double density graphic mode [120 dots per inch(25.4 mm) /960 dots per line].

Name: ESC "L" n₁ n₂ Data
Dec.: 27 76 n₁ n₂ Data
Hex.: 1B 4C n₁ n₂ Data

(See Section 5.3)

DOUBLE SPEED, DOUBLE DENSITY GRAPHICS:

Sets double speed, double density graphics mode [120 dots per inch (25.4 mm)/960 dots per line].

Name: ESC "Y" n₁ n₂ Data
Dec.: 27 89 n₁ n₂ Data
Hex.: 1B 59 n₁ n₂ Data

Comment:

- Horizontally adjacent dots cannot be printed.
(See Section 5.3)

IBM Proprinter X24 Mode Commands

8-PIN QUADRUPLE DENSITY GRAPHICS:

Sets quadruple density graphics mode [240 dots per inch (25.4 mm) /1920 dots per line].

Name: ESC "Z" n₁ n₂ Data
Dec.: 27 90 n₁ n₂ Data
Hex.: 1B 5A n₁ n₂ Data

Comment:

- Horizontally adjacent dots cannot be printed. (See Section 5.3)

BIT IMAGE MODE SELECTION (AGM):

Selects one of the 8-pin or 24-pin bit image graphic modes (AGM only).

Name: ESC "*" m n₁ n₂ Data
(m=0, 1, 2, 3, 4, 6, 32, 33, 38, 39, 40)
Dec.: 27 42 m n₁ n₂ Data
Hex.: 1B 2A m n₁ n₂ Data

Comments:

- The following table illustrates the various modes based upon the values of m.

m	Pin	Dots/Inch	Dots/Line	
0	8	60	480	Standard Density
1	8	120	960	Double Density
2	8	120	960	Double Speed, Double Density
3	8	240	1920	Quadruple Density
4	8	80	640	CRT I
6	8	90	720	CRT II
32	24	60	480	Standard Density
33	24	120	960	Double Density
38	24	90	720	CRT III
39	24	180	1440	Triple Density
40	24	360	2880	Hex Density

- When m=2, 3, 40 Horizontal adjacent dots cannot be printed.
- This command is effective only when AGM mode is set to ON in the Initial Setup mode. (See pages 3-20, 5-20)

IBM Proprinter X24 Mode Commands

BIT IMAGE MODE SELECTION:

Selects one of the 8-pin or 24-pin bit image graphic modes.

Name: ESC “[” “g” n₁ n₂ m Data
(m=0, 1, 2, 3, 8, 9, 11, 12)
Dec.: 27 91 103 n₁ n₂ m Data
Hex.: 1B 5B 67 n₁ n₂ m Data

Comments:

- The following table illustrates the various modes based upon the values of m.

m	Pin	Dots/Inch	Dots/Line	
0	8	60	480	Standard Density
1	8	120	960	Double Density
2	8	120	960	Double Speed, Double Density
3	8	240	1920	Quadruple Density
8	24	60	480	Standard Density
9	24	120	960	Double Density
11	24	180	1440	Triple Density
12	24	360	2880	Hex Density

- When m=2, 3, 12, Horizontal adjacent dots cannot be printed.
(See Section 5.3)

1/8 INCH PAPER FEED :

Sets paper feed amount to 1/8 inch (3.2 mm).

Name: ESC “0”
Dec.: 27 48
Hex.: 1B 30

IBM Proprinter X24 Mode Commands

7/72 INCH PAPER FEED:

Sets paper feed amount to 7/72 inch (2.5 mm).

Name:	ESC	"1"
Dec.:	27	49
Hex.:	1B	31

LINE SPACING:

Executes line spacing set by ESC+"A"+n.

Name:	ESC	"2"
Dec.:	27	50
Hex.:	1B	32

7

n/72 INCH PAPER FEED SELECTION:

Sets programmable paper feed amount to n/72 inch.

Name:	ESC	"A"	n
Dec.:	27	65	n
Hex.:	1B	41	n

Comments:

- ESC+"2" must be input after ESC+"A"+n for n/72 inch paper feed to become effective (when AGM is set to OFF only).
- n/72 inch paper feed is valid for $0 \leq n \leq 255$.
- The IBM Proprinter X24 mode defaults to 1/6 inch.
- In the AGM mode, this command sets one line paper feed of n/60 inch. (See pages 3-21, 5-20)

IBM Proprinter X24 Mode Commands

n/216 INCH PAPER FEED SELECTION:

Sets programmable paper feed amount to n/216 inch.

Name: ESC "3" n
Dec.: 27 51 n
Hex.: 1B 33 n

Comments:

- n/216 inch paper feed is valid for $0 \leq n \leq 255$.
- The paper feed amount is not exactly n/216 inch, for the minimum unit is 1/360 inch.
- The command sets one line paper feed of n/180 inch in the AGM mode. (See pages 3-21, 5-20)

7

LINE FEED PITCH SELECTION

Selects line base unit for ESC+"3" and ESC+"J".

Name: ESC "[" "\" n₁ n₂ n₃ n₄ n₅ n₆
Dec.: 27 91 92 n₁ n₂ n₃ n₄ n₅ n₆
Hex.: 1B 5B 5C n₁ n₂ n₃ n₄ n₅ n₆

Comments:

- The values of n₁, n₂, n₃, n₄ and n₅ must be used as follows:

$$n_1=4$$

$$n_2=n_3=n_4=n_5=0$$

- The value of n₆ selects the base line feed unit for ESC+"3" and ESC+"J".

	Base unit
n ₆ =180	1/180 inch
n ₆ =216	1/216 inch

- Other values of n₆ are unsupported.

IBM Proprinter X24 Mode Commands

AUTOMATIC LINE FEED MODE:

Automatically executes a Line Feed following a Carriage Return.

Name:	Set:	ESC	"5"	1	Release:	ESC	"5"	0
Dec.:		27	53	1		27	53	0
Hex.:		1B	35	01		1B	35	00

Comment:

- Initial Setup mode also controls the auto line feed function (refer to Section 3.3). Setting this mode to ON is equivalent to executing the ESC+"5"+1 command. Similarly, setting the mode to OFF is equivalent to executing the ESC+"5"+0 command.

LINE FEED (LF):

Causes data in buffer to be printed and then executes a single line feed.

7

Name:	LF
Dec.:	10
Hex.:	0A

Comments:

- When the new line position falls within the skip perforation area, the paper advances to the next top of form position.
- If there is no data, "space" data (ASCII 32), or blanks between HT print positions in the buffer, LF feeds the paper 1 line.
- The amount of spacing generated by LF is a function of the paper feed amount setting.
- LF code releases single-line double width printing set by SO and ESC+SO.
- Initial Setup mode controls the Automatic CR function. When this mode is set to OFF, LF executes a single line feed; with no carriage movement. When this mode is set to ON, a Carriage Return command (CR) is added to each Line Feed (LF).

IBM Proprinter X24 Mode Commands

FORM FEED (FF):

Feeds paper to next top of form position after printing any data in the buffer.

Name: FF
Dec.: 12
Hex.: 0C

Comments:

- FF releases single-line double width printing set by SO or ESC+SO.
 - Amount of form feed depends upon the page length set by the page length control command or the EZ Set Operator Panel.
-

7

n/216 INCH PAPER FEED SELECTION:

Prints out the data in the print buffer and feeds the paper n/216 inch or n/180 inch.

Name: ESC "J" n
Dec.: 27 74 n
Hex.: 1B 4A n

Comments:

- When Automatic CR is set to ON in the Initial Setup mode, Carriage Return command (CR) is added automatically to this command.
- The value of n is valid for $0 \leq n \leq 255$.
- This command sets the paper feed for one line only. Subsequent paper feed returns to previous setting. However, the carriage does not return to the left margin position. Instead, printing of next line begins where previous printing left off.
- This command does not release single-line double width printing.
- The paper feed amount is not exactly n/216 inch, for the minimum unit is 1/360 inch.
- In the AGM mode, this command sets one line paper feed of n/180 inch. (See pages 3-21, 5-20)

IBM Proprinter X24 Mode Commands

PAGE LENGTH (INCHES):

Sets page length in inches.

Name:	ESC	"C"	0	n
Dec.:	27	67	0	n
Hex.:	1B	43	00	n

Comments:

- Upon receipt of ESC+"C"+0+n, the present line position becomes the top of page position.
- The value of n must be in the range $1 \leq n \leq 255$.
- ESC+"C"+0+n releases the skip perforation settings.
- The page length does not change even if the paper feed amount is changed.
- The terms "form" and "page" are interchangeable.

7

PAGE LENGTH (LINES):

Sets page length in number of lines.

Name:	ESC	"C"	n
Dec.:	27	67	n
Hex.:	1B	43	n

Comments:

- Upon receipt of ESC+"C"+n, the present line position becomes the top of page position.
- The value on n must be in the range $1 \leq n \leq 255$. If n=0, page length returns to the inch designation.
- ESC+"C"+n releases the skip perforation settings.
- The page length does not change even if the paper feed amount is changed.
- The terms "form" and "page" are interchangeable.

IBM Proprinter X24 Mode Commands

MARGIN SET:

Sets positions of left and right margins.

Name:	ESC	"X"	n ₁	n ₂
Dec.:	27	88	n ₁	n ₂
Hex.:	1B	58	n ₁	n ₂

Comments:

- The left margin column is set to n₁ in the current width, and the right margin column is set to n₂.
- Permissible values of n₁, n₂ are given below.

Pica print	0 ≤ n ₁ ≤ 78	2 ≤ n ₂ ≤ 80
Elite print	0 ≤ n ₁ ≤ 93	3 ≤ n ₂ ≤ 96
Compressed print	0 ≤ n ₁ ≤ 133	4 ≤ n ₂ ≤ 137
- Any right margin designation to the left of the left margin position is ignored.
- Setting the margin clears all data in the buffer.
- Once the margin position is set, a change in the pitch will not alter this margin setting.
- When n₁=0, the left margin does not change. When n₂=0, the right margin does not change.

7

SKIP PERFORATION:

Sets skip perforation.

Name:	Set:	ESC	"N"	n	Release:	ESC	"O"
Dec.:		27	78	n		27	79
Hex.:		1B	4E	n		1B	4F

Comments:

- The value of n specifies the number of lines (or n times the current line spacing amount) to be skipped at the bottom of the page.
- This command is effective only for 0 ≤ n ≤ 255.
- The skip perforation amount does not change even if the paper feed amount is changed following a skip perforation designation.
- The skip perforation is released upon receipt of the page length designation command.
- If Initial Setup mode is ON, the skip perforation amount is set to 1 inch (25.4 mm) unless changed by this command. If the mode is OFF, skip perforation is not executed unless specified by ESC+"N"+n.
- ESC+"O" will override the skip perforation established when Initial Setup mode is set to ON.

IBM Proprinter X24 Mode Commands

TOP OF FORM:

Sets top of form.

Name:	ESC	"4"
Dec.:	27	52
Hex.:	1B	34

Comment:

- This command sets the current paper position as the top of form.

HORIZONTAL TAB STOP SETTING:

Sets horizontal tabulations to specified values.

	Set:			Release:			
Name:	ESC	"D"	$n_1 \dots n_x$	0	ESC	"D"	0
Dec.:	27	68	$n_1 \dots n_x$	0	27	68	0
Hex.:	1B	44	$n_1 \dots n_x$	00	1B	44	00

7

Comments:

- Horizontal tabs are set from the left margin position.
- Horizontal tabs must be designated such that $n_1 < n_2 < \dots < n_x$.
- A maximum of 32 tabs may be set on a single line.
- ESC+"D"+ $n_1+n_2+\dots+n_x+0$ sets horizontal tab stops. The HT command executes the tab designation.
- In proportional spacing, horizontal tabs are set based on 10 cpi.
- If the character pitch is altered after designation of horizontal tabs, the tab positions change.
- When the left margin is changed, horizontal tabs will be moved based on the new margin setting.
- When the printer is powered up, tabs are automatically set every 8 characters.

IBM Proprinter X24 Mode Commands

HORIZONTAL TAB EXECUTION:

Executes the horizontal TAB as designated by ESC+"D"+n₁+n₂+...+n_x+0

Name: HT
Dec.: 9
Hex.: 09

Comments:

- If the value of the horizontal TAB is less than the present column position, then HT is ignored.
- When in underline mode, the blank spaces between consecutive HT print positions are not underlined.

7

VERTICAL TAB STOP SETTING:

Sets vertical tabulation to specified values.

	Set:				Release:		
Name:	ESC	"B"	n ₁ ...n _x	0	ESC	"B"	0
Dec.:	27	66	n ₁ ...n _x	0	27	66	0
Hex.:	1B	42	n ₁ ...n _x	00	1B	42	00

Comments:

- VT is set from the top of page position.
- Vertical tabs must be designated such that n₁<n₂<...<n_x.
- A maximum of 64 tabs may be set.
- ESC+"B"+n₁+n₂+...+n_x+0 sets vertical tab stops. The VT command executes the tab designation.
- If the paper feed amount is changed after a designation of vertical tabs, the tab positions do not change.

IBM Proprinter X24 Mode Commands

VERTICAL TAB EXECUTION:

Executes the vertical TAB as designated by ESC+"B"+n₁+n₂+...+n_x+0.

Name: VT
Dec.: 11
Hex.: 0B

Comments:

- When TABs are set with VT setting command and there is no tab setting on a position exceeding the present line, data is printed out and advances the paper one line (same as LF).
- When vertical TAB has not been set by ESC+"B"+n₁+n₂+...+n_x+0, execution of VT causes data in the buffer to be printed and advances the paper one line (same function as LF).

ALL TAB INITIAL CLEAR:

Sets all tabs to power ON settings.

Name: ESC "R"
Dec.: 27 82
Hex.: 1B 52

Comment:

- This command sets horizontal tabs at every 8th position, and clears all vertical tabs.

IBM Proprinter X24 Mode Commands

BACKSPACE:

Prints data in buffer and backspaces one space before printing next character.

Name: BS
Dec.: 8
Hex.: 08

Comment:

- Since BS backspaces the width of a character, the backspacing amount will depend upon the pitch set when the BS code is executed.

CARRIAGE RETURN:

Prints all data in buffer and designates that the next line starts at the left margin.

Name: CR
Dec.: 13
Hex.: 0D

Comments:

- Certain computers issue an automatic line feed with a carriage return. Check your computer manual for details.
- When auto LF is set to ON in the Initial Setup mode, the paper is fed automatically (a LF is executed automatically) whenever a CR code is executed.
- CR code releases single line double width printing set by SO or ESC+SO.

SINGLE DIRECTION:

Sets single direction (left to right) printing mode.

Name:	Set:	ESC	"U"	1	Release:	ESC	"U"	0
Dec.:		27	85	1		27	85	0
Hex.:		1B	55	01		1B	55	00

IBM Proprinter X24 Mode Commands

RELATIVE HORIZONTAL POSITION:

Moves the printhead toward the right $n/120$ inch.

Name:	ESC	"d"	n_1	n_2
Dec.:	27	100	n_1	n_2
Hex.:	1B	64	n_1	n_2

Comments:

- When underlining or overlining, spaces created by the move are underlined or overlined.
 - This command moves the printhead to a position $n_1+(256 \times n_2)$ units from the current position. Each unit equals 1/120 of an inch.
-

CANCEL:

Clears all data in the buffer.

Name:	CAN
Dec.:	24
Hex.:	18

7

REMOTE PRINTER SELECT:

Selects the printer remotely, enabling it to receive data.

Name:	DC1	(Device Control 1)
Dec.:	17	
Hex.:	11	

Comments:

- Receipt of DC1 while the printer is deselected by ESC+"Q"+36 enables the printer to receive data.
- The data received between ESC+"Q"+36 and DC1 is lost.

IBM Proprinter X24 Mode Commands

REMOTE DESELECT PRINTER:

Deselects the printer remotely, disabling it from receiving data.

Name: ESC "Q" 36
Dec.: 27 81 36
Hex.: 1B 51 24

Comment:

- All data sent in deselect status becomes invalid. In order to return to select status, send DC1 code.
-

FONT DOWNLOADING:

Defines download characters into specified address locations in RAM.

Name: ESC "=" n₁ n₂ 35 A₁ A₂ Data
Dec.: 27 61 n₁ n₂ 35 A₁ A₂ Data
Hex.: 1B 3D n₁ n₂ 23 A₁ A₂ Data

Comments:

- This command is operational only when the 32K buffer option (KX-P43) is installed.
 - When n₁=n₂=0, download characters are all cleared.
 - Refer to Section 5.2 on page 5-3 for detailed information.
-

BELL:

Sounds buzzer for approximately 0.5 second.

Name: BEL
Dec.: 7
Hex.: 07

IBM Proprinter X24 Mode Commands

ESCAPE:

First byte of each multi-byte printer control code.

Name: ESC
Dec.: 27
Hex.: 1B

Comment:

- Cannot be generated by the ESC key on certain computers.
-

NULL:

Last byte of certain multi-byte printer control codes.

Name: NUL
Dec.: 0
Hex.: 00

7

ALL CHARACTER CHART PRINTING

(Continuous):

Prints continuously from All Character Chart.

Name: ESC “\” n₁ n₂
Dec.: 27 92 n₁ n₂
Hex.: 1B 5C n₁ n₂

Comments:

- This command allows the printing of all characters including characters with an ASCII value below decimal 32.
- Refer to IBM All Character Chart. (Appendix A).
- The values specified for n₁ and n₂ indicate how many characters to print from All Character Chart, calculating the total count with this formula; Total count=n₂×256+n₁.
- The data following this command and designated by n₁ and n₂, will be printed as characters from the All Character Chart.

IBM Proprinter X24 Mode Commands

ALL CHARACTER CHART PRINTING (Single):

Prints single character from All Character Chart.

Name: ESC “^”
Dec.: 27 94
Hex.: 1B 5E

Comments:

- Only the character following this command will be printed.
 - Refer to IBM All Character Chart (Appendix A).
-

SETS OFF LINE MODE:

Stops printing and goes to OFF LINE mode.

Name: ESC “j”
Dec.: 27 106
Hex.: 1B 6A

Comment:

- When you desire to print again, press the ON LINE switch.

8. Interfacing

Parallel Interfacing

Communication with a computer is accomplished through a parallel interface based on the Centronics standard.

Specifications:

- data transfer speed: 1000 cps minimum
- synchronization: external STROBE pulse
- logic levels: TTL
- handshaking: BUSY and \overline{ACK} signals
- connector type: 57-30360 (AMPHENOL) or equivalent
- cable: use a shielded cable (6'5"/1.95 meters) or less in length.

When the printer is processing data, the BUSY signal is high. The printer will not accept new data from the computer. After the processing is completed, the BUSY signal goes low. (The BUSY signal is also high when the printer is OFF LINE). When the BUSY signal occurs, the \overline{ACK} signal goes low indicating to the computer that the data has been processed and the printer is ready to accept more data. This handshaking routine occurs each time a character is sent to the printer.

	BUSY	SLCT	PO	ERROR
ON LINE	LOW	HIGH	LOW	HIGH
OFF LINE	HIGH	LOW	LOW	LOW
PAPER OUT	HIGH	LOW	HIGH	LOW

Printer Status signals

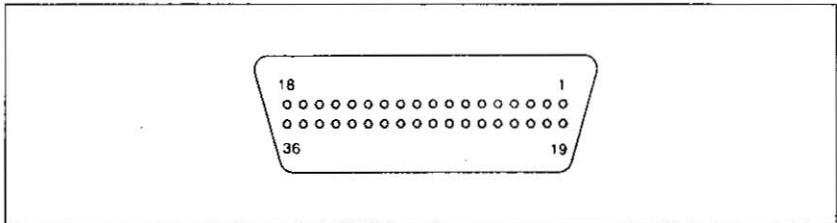

Parallel Interface Connector (Printer side)

Interfacing

Signal pin	Return side pin	Signal	Direction
1	19	$\overline{\text{STB}}$	Input
2	20	DATA 1	Input
3	21	DATA 2	
4	22	DATA 3	
5	23	DATA 4	
6	24	DATA 5	
7	25	DATA 6	
8	26	DATA 7	
9	27	DATA 8	
10	28	$\overline{\text{ACK}}$	Output
11	29	BUSY	
12		PO	
13		SLCT	
14		AUTO FEED XT	Input
15			
16		SG	
17		FG	
18		+5 V	Output
31	30	$\overline{\text{PRIME}}$	Input
32		$\overline{\text{ERROR}}$	Output
33		SG	
34			
35			
36			

Pin Configuration (Parallel)

Note:

- "INPUT" refers to a signal coming into the printer.
"OUTPUT" denotes a signal exiting the printer.
- "RETURN" denotes the return side wire of a twisted pair cable and is connected to signal ground.
- All interface signals are at TTL (Transistor-Transistor-Logic) levels.

Connector pin signals

STB...STROBE

- This is a synchronizing input signal to read data.
- This signal is normally high. Data is read in when it goes low.
- The pulse width must be low for at least 1 microsecond.

DATA 1-DATA 8

- These are the input signals which carry the 8 data bits of information.
- The signal is read in synchronization with the STROBE pulse. A high level indicates a logical "1"
- The signal must be present 0.5 microseconds before and after the STROBE pulse.

ACK...ACKNOWLEDGE

- This is an output signal to the computer indicating that the printer is ready to receive the next block of data. It is sent out when the BUSY signal drops from high to low. Therefore, it can be thought of as a data request pulse.
- The signal is normally high. When the signal becomes active, it goes low.
- The ACK signal is automatically sent whenever the printer is switched ON LINE.

BUSY

- This output signal indicates the status of the printer. The signal is high when the printer is busy and cannot receive data.
- The signal is high under the following conditions:
 1. receive buffer is full
 2. printer is processing data
 3. printer is OFF LINE
 4. printer is in an error condition

PO...PAPER OUT

- This output signal indicates that the paper out detector detects the absence of paper.
- The signal is normally low and goes high during a "Paper Out" condition.

Interfacing

SLCT...SELECT

- SELECT is an output signal which indicates the ON LINE or OFF LINE state of the printer. The signal is high in the ON LINE state and low when OFF LINE.
- The printer enters the ON LINE state:
 1. when the printer is turned on
 2. when $\overline{\text{PRIME}}$ is received
 3. when the RESET command is received
 4. when the ON LINE switch is pressed
- The printer enters the OFF LINE state:
 1. when the printer is out of paper
 2. when the printer is switched OFF LINE

$\overline{\text{AUTO FEED XT}}$ ($\overline{\text{AFXT}}$)

- This input signal determines if a line feed (LF) command will be added to each carriage return (CR).
- When $\overline{\text{AFXT}}$ is low, CR+LF action occurs. When $\overline{\text{AFXT}}$ is high, only a carriage return is performed.
- Auto LF setting in the Control Table can alter the response by the printer to an $\overline{\text{AFXT}}$ signal. If auto LF is ON, the printer will perform a CR+LF regardless of the level of the incoming signal. When auto LF is OFF, this automatic action is disabled.

SG...SIGNAL GROUND

- The twisted pair return wires (pins 19-30) are connected to signal ground.

FG...FRAME GROUND

- Frame ground is the same as chassis ground.

+5 V

- This is for evaluation only. It should not be used to supply power for external equipment.

PRIME

- This input signal is used to initialize the printer. The signal is normally high and goes low to reset the printer. It can be received anytime during printer operation.

ERROR

- This output signal is an “error” or “fault” condition. Normally high, this signal goes low when an error occurs. An error condition can be caused by:
 1. a “Paper Out” condition
 2. the printer is OFF LINE
 3. an overload condition exists

Timing Chart (When normal printing code is received)

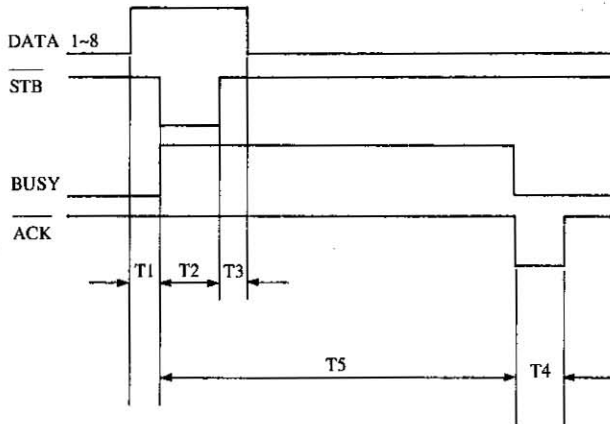

- T1...0.5 μ s (Min)
- T2...1 μ s (Min)
- T3...0.5 μ s (Min)
- T4...5 μ s (Max)
- T5...1 ms or less when buffer not full
1 s or less when buffer full

Timing Diagram

9. Maintenance

The printer does not require any routine maintenance. However, reasonable care of the printer will extend its life. The following precautions and periodic measures are recommended:

Precautions

- Keep all liquids away from the printer. Accidental spillage of a liquid into the printer can cause severe damage.
- Do not block the air flow around the printer. Do not place books, paper, or other items on top of the printer.
- Special care should be taken to protect the printer if it is used in an unfriendly environment such as a machine shop, a dusty or sandy area, etc.
- The life of the printhead can be extended by observing a few simple precautions.
 - Do not operate the printer without paper and a ribbon cassette installed.
 - Avoid prolonged use without allowing the printhead time to cool.
 - Do not obstruct the movement of the printhead while in operation.
- If the printer is not going to be used for an extended period, unplug the power cord.

Periodic Maintenance

- Cleaning the unit is the most important action the user can perform. The frequency of cleaning is dependent upon the environment.
 - Turn the power OFF.
 - Clean the case and covers with a soft cloth. Use any mild commercial cleaner on the cloth, do not spray directly on to the printer.

- Remove the top and the smoked plastic covers. Vacuum or dust the inside area of the unit. Be very careful not to damage the flex ribbon cable and the carriage drive belt.
- The platen should be cleaned with denatured alcohol only.
- The carriage guide bar can be lubricated with a very light oil. Contact your Authorized Panasonic Service Center for advice on lubrication.

Ribbon Cassette

A single ribbon permits the printing of about 3 million characters. When the printing starts to fade, gently push the counter spring in the ribbon cassette hole with the tip of a ballpoint pen or other object. **Once the ribbon cassette is mounted onto the carriage and printing is performed for a short time, the characters will become darker.**

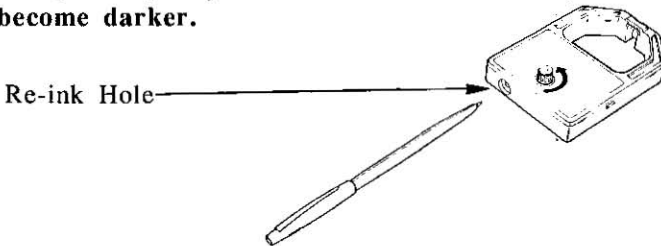

Note:

- Do not re-ink the ribbon before printing starts to fade. If the ribbon has too much ink the characters may smear when printed.
- Wear and tear of the printhead pins may cause serious damage to the ribbon and printing to fade. In such case the printer needs servicing.

Troubleshooting

Most problems associated with the printer can be traced to improper setup, installation, or cabling. Table 9.1 on next page will assist the user in identifying and correcting some of the more common problems. If you need additional help, contact the store from which the unit was purchased.

Maintenance

SYMPTOM	POSSIBLE CAUSE	PROBABLE SOLUTION
Printer does not power up	No AC power	Check power cord
Power on but printer not printing	Printer not ON LINE	Press ON LINE switch
	Interface cable not connected	Secure connection
Printer won't go ON LINE	Out of Paper	Replace paper
Paper out sensor inoperative	*P.O. Disable	*Set P.O. Enable
Paper slips around platen	Paper feed selector in "T" position	Set selector to "F" position
Head moves but does not print	Ribbon not installed correctly	Re-insert ribbon
Paper wrinkles when using tractor feed	No reverse tension on paper.	Set paper supply lower than printer.
	Selector switch is in "F" position	Set selector to "T" position
Cannot change form length	*Cut sheet feeder is ON	*Set CSF to OFF
Printout double-spaced	*Auto LF is ON	*Set Auto LF as required
Cannot print ASCII characters with code above 127	*Data length set incorrectly	*Set Data length as required
Wrong character set printed	*Wrong characters set selected	*Set the character set as required
Cannot change print mode from computer	FONT and PITCH modes are set incorrectly	Set to PROGRAM mode

Table 9.1 Troubleshooting

(* in the Initial Setup mode. See page 3-20)

Appendix A



























Epson LQ-850 Italic Character Set

	0	1	2	3	4	5	6	7	8	9	A	B	C	D	E	F	
0	NUL		SP	0	@	P	'	p			SP	0	@	P	'	p	
1		DC1	!	1	A	Q	a	q			DC1	!	1	A	Q	a	q
2		DC2	"	2	B	R	b	r			DC2	"	2	B	R	b	r
3		DC3	#	3	C	S	c	s			DC3	#	3	C	S	c	s
4		DC4	\$	4	D	T	d	t			DC4	\$	4	D	T	d	t
5			%	5	E	U	e	u			%	5	E	U	e	u	
6			&	6	F	V	f	v			&	6	F	V	f	v	
7	BEL		'	7	G	W	g	w	BEL		'	7	G	W	g	w	
8	BS	CAN	(8	H	X	h	x	BS	CAN	(8	H	X	h	x	
9	HT	EM)	9	I	Y	i	y	HT	EM)	9	I	Y	i	y	
A	LF		*	:	J	Z	j	z	LF		*	:	J	Z	j	z	
B	VT	ESC	+	;	K	[k	{	VT	ESC	+	;	K	[k	{	
C	FF		,	<	L	\	l		FF		,	<	L	\	l		
D	CR		-	=	M]	m	}	CR		-	=	M]	m	}	
E	SO		.	>	N	^	n	~	SO		.	>	N	^	n	~	
F	SI		/	?	O	_	o	DEL	SI		/	?	O	_	o	DEL	

A

Appendix A

Epson LQ-850 Graphic Character Set 1

	0	1	2	3	4	5	6	7	8	9	A	B	C	D	E	F
0	NUL		SP	0	@	P	'	p			á		L	ll	α	≡
1		DC1		1	A	Q	a	q		DC1	í		l	ll	β	±
2		DC2	"	2	B	R	b	r		DC2	ó		l	ll	Γ	≥
3		DC3	#	3	C	S	c	s		DC3	ú		l	ll	π	≤
4		DC4	\$	4	D	T	d	t		DC4	ñ		l	ll	Σ	
5		§	%	5	E	U	e	u			Ñ		l	ll	F	σ
6			&	6	F	V	f	v			a		l	ll	μ	+
7	BEL		'	7	G	W	g	w	BEL		o		l	ll	τ	≈
8	BS	CAN	(8	H	X	h	x	BS	CAN	¿		l	ll	Φ	°
9	HT	EM)	9	I	Y	i	y	HT	EM	¡		l	ll	θ	•
A	LF		*	:	J	Z	j	z	LF		¡		l	ll	Ω	•
B	VT	ESC	+	:	K	[k	{	VT	ESC	½				δ	√
C	FF		,	<	L	\	l		FF		¼				∞	"
D	CR		-	=	M]	m	}	CR		i				ø	²
E	SO		.	>	N	^	n	~	SO		<<				€	■
F	SI		/	?	O	_	o	DEL	SI		>>				∩	

A

Epson LQ-850 Graphic Character Set 2

	0	1	2	3	4	5	6	7	8	9	A	B	C	D	E	F
0	NUL		SP	0	@	P	'	p	Ç	É	á				α	≡
1		DC1	!	1	A	Q	a	q	ú	æ	í				β	±
2		DC2	"	2	B	R	b	r	é	Æ	ó				Γ	≥
3		DC3	#	3	C	S	c	s	â	ô	ú				π	≤
4		DC4	\$	4	D	T	d	t	ä	ö	ñ	-	-		Σ	
5		§	%	5	E	U	e	u	à	ò	Ñ	=			σ	
6			&	6	F	V	f	v	â	û	ä				μ	+
7	BEL		'	7	G	W	g	w	ç	ù	ø				τ	≈
8	BS	CAN	(8	H	X	h	x	ê	ÿ	¿				Φ	°
9	HT	EM)	9	I	Y	i	y	ë	Ö	¡				θ	•
A	LF		*	:	J	Z	j	z	è	Ü	¢				Ω	•
B	VT	ESC	+	;	K	[k	{	ı	¢	½				δ	√
C	FF		,	<	L	\	l		î	£	¼				∞	∞
D	CR		-	=	M]	m	}	ï	¥	ı				ø	²
E	SO		.	>	N	^	n		Ä	Pt	<<				€	■
F	SI		/	?	O	_	o	DEL	Å	f	>>				∩	

A

Appendix A

IBM Proprinter X24 Character Set 1

	0	1	2	3	4	5	6	7	8	9	A	B	C	D	E	F
0	NUL		SP	0	@	P	`	p			á		L	ll	α	≡
1		DC1	!	1	A	Q	a	q		DC1	í		l	ll	β	±
2		DC2	"	2	B	R	b	r		DC2	ó		l	ll	Γ	≥
3			#	3	C	S	c	s			ú	l	ll	ll	π	≤
4		DC4	\$	4	D	T	d	t		DC4	ñ	l	ll	E	Σ	∫
5			%	5	E	U	e	u			Ñ	l	ll	F	σ	∫
6			&	6	F	V	f	v			á	l	ll	ll	μ	+
7	BEL		'	7	G	W	g	w	BEL		o	l	ll	ll	τ	≈
8	BS CAN	(8	H	X	h	x	BS CAN		¿	l	ll	ll	Φ	°
9	HT)		9	I	Y	i	y	HT		∟	l	ll	ll	θ	•
A	LF	*	:	J	Z	j	z	LF			∟	l	ll	ll	Ω	•
B	VT ESC	+	;	K	[k	{	VT ESC	½		∟	l	ll		δ	√
C	FF	,	<	L	\	l		FF	¼		∟	l	ll		∞	∞
D	CR	-	=	M]	m	}	CR			l	ll	ll		∅	²
E	SO	.	>	N	^	n	~	SO	<<		l	ll	ll		ε	■
F	SI	/	?	O	_	o		SI	>>		l	ll	ll		∩	SP

A

IBM Proprinter X24 Character Set 2

	0	1	2	3	4	5	6	7	8	9	A	B	C	D	E	F
0	NUL		SP	0	@	P	`	p	Ç	É	á	█	⌈	⌋	α	≡
1		DC1	!	1	A	Q	a	q	ü	æ	í	█	⌈	⌋	β	±
2		DC2	"	2	B	R	b	r	é	Æ	ó	█	⌈	⌋	Γ	≥
3	♥		#	3	C	S	c	s	â	ô	ú	█	⌈	⌋	π	≤
4	♦	DC4	\$	4	D	T	d	t	ä	ö	ñ	█	⌈	⌋	Σ	∫
5	♣	§	%	5	E	U	e	u	à	ò	Ñ	█	⌈	⌋	σ	∫
6	♠		&	6	F	V	f	v	á	û	ä	█	⌈	⌋	μ	+
7	BEL		'	7	G	W	g	w	ç	ù	ö	█	⌈	⌋	τ	≈
8	BS	CAN	(8	H	X	h	x	è	ý	¿	█	⌈	⌋	Φ	°
9	HT)	9	I	Y	i	y	ë	Ö	⌈	█	⌈	⌋	θ	•
A	LF		*	:	J	Z	j	z	è	Ü	⌈	█	⌈	⌋	Ω	•
B	VT	ESC	+	;	K	[k	{	ï	φ	½	█	⌈	█	δ	√
C	FF		,	<	L	\	l		î	£	¼	█	⌈	█	∞	°
D	CR		-	=	M]	m	}	ï	¥	ï	█	⌈	█	∅	²
E	SO		.	>	N	^	n	~	Ä	Pts	<<	█	⌈	█	ε	■
F	SI		/	?	O	_	o		Å	f	>>	█	⌈	█	∩	SP

A

Appendix A

IBM Proprinter X24 All Character Chart

	0	1	2	3	4	5	6	7	8	9	A	B	C	D	E	F
0	∅	▶	SP	0	@	P	·	p	Ç	É	á		L	⊥	α	≡
1	☉	◀	!	1	A	Q	a	q	ü	æ	í		⊥	⊥	β	±
2	●	↑	"	2	B	R	b	r	é	Æ	ó		⊥	⊥	Γ	≥
3	♥	!!	#	3	C	S	c	s	â	ô	ú	⊥	⊥	⊥	π	≤
4	♦	¶	\$	4	D	T	d	t	ä	ö	ñ	⊥	⊥	⊥	Σ	∫
5	♣	§	%	5	E	U	e	ú	à	ò	Ñ	⊥	⊥	⊥	σ	∫
6	♠	-	&	6	F	V	f	v	á	û	ä	⊥	⊥	⊥	μ	÷
7	•	↑	'	7	G	W	g	w	ç	ù	ö	⊥	⊥	⊥	τ	≈
8	◻	↑	(8	H	X	h	x	ê	ÿ	¿	⊥	⊥	⊥	Φ	°
9	○	↓)	9	I	Y	i	y	ë	Ö	⊥	⊥	⊥	⊥	θ	•
A	◻	→	*	:	J	Z	j	z	è	Ü	⊥	⊥	⊥	⊥	Ω	•
B	♂	←	+	:	K	[k	{	ï	φ	½	⊥	⊥		δ	√
C	♀	L	,	<	L	\	l		î	£	¼	⊥	⊥		∞	"
D	♪	↔	-	=	M]	m	}	ï	¥	í	⊥	⊥		∅	²
E	♫	▲	.	>	N	^	n	˘	Ä	Pts	<<	⊥	⊥		ε	■
F	♣	▼	/	?	O	_	o	△	Å	f	>>	⊥	⊥		∩	SP

A

International Character Set

	n	35 _o 23 _H	36 _o 24 _H	64 _o 40 _H	91 _o 5B _H	92 _o 5C _H	93 _o 5D _H	94 _o 5E _H	96 _o 60 _H	123 _o 7B _H	124 _o 7C _H	125 _o 7D _H	126 _o 7E _H	155 _o 98 _H	157 _o 9D _H
USA	0	#	\$	@	[\]	^	'	{		}	-	¢	¥
FRANCE	1	#	\$	à	°	ç	§	^	'	é	ù	è	~	¢	¥
GERMANY	2	#	\$	§	Ä	Ö	Ü	^	'	ä	ö	ü	ß	¢	¥
ENGLAND	3	£	\$	@	[\]	^	'	{		}	-	¢	¥
DENMARK 1	4	#	\$	@	Æ	Ø	Å	^	'	æ	ø	å	-	ø	Ø
SWEDEN	5	#	¤	É	Ä	Ö	Å	Ü	é	ä	ö	å	ü	¢	¥
ITALY	6	#	\$	@	°	\	é	^	ù	à	ò	è	ì	¢	¥
SPAIN 1	7	Pt	\$	@	ì	Ñ	¿	^	'	ñ	}	-	¢	¥	
JAPAN	8	#	\$	@	[¥]	^	'	{		}	-	¢	¥
NORWAY	9	#	¤	É	Æ	Ø	Å	Ü	é	æ	ø	å	ü	ø	Ø
DENMARK 2	10	#	\$	É	Æ	Ø	Å	Ü	é	æ	ø	å	ü	ø	Ø
SPAIN 2	11	#	\$	á	ì	Ñ	¿	é	'	í	ñ	ó	ú	¢	¥
LATIN AMERICA	12	#	\$	á	ì	Ñ	¿	é	ü	í	ñ	ó	ú	¢	¥
LEGAL	64	#	\$	§	°	'	”	¶	'	©	®	†	™	¢	¥

*1

*2

Note:

*1. These characters can be changed only in the LQ-850 mode. In the IBM Proprinter X24 mode, International Character Set is set to USA and it can not be changed.

*2. These characters are effective in both graphic character set 2 of the Epson LQ-850 and IBM Proprinter X24 modes.

Appendix B

Proportional Spacing Tables

ASCII Characters

Epson LQ-850 mode characters

ASCII code	Char.	Width	
		Normal	Script
0	à	30	20
1	è	30	20
2	ù	36	24
3	ò	30	20
4	ì	18	12
5	°	24	16
6	£	30	20
7	ı	30	20
8	ı	30	20
9	Ñ	36	24
10	ñ	36	24
11	ı	30	20
12	Pl	42	28
13	À	36	24
14	á	30	20
15	ç	30	20
16	§	30	20
17	ß	36	24
18	Æ	42	28
19	ø	42	28
20	ø	36	24
21	ø	30	20
22	·	30	20
23	Ä	36	24
24	Ö	36	24
25	Ü	42	28
26	ä	30	20
27	ö	30	20
28	ü	36	24
29	É	36	24
30	é	30	20
31	¥	36	24
32	SPACE	30	20
33	!	18	12
34	"	30	20
35	#	30	20
36	\$	30	20
37	%	36	24
38	&	36	24
39	'	18	12
40	(24	16
41)	24	16
42	*	30	20
43	+	30	20

ASCII code	Char.	Width	
		Normal	Script
44	,	18	12
45	-	30	20
46	.	18	12
47	/	30	20
48	0	30	20
49	1	30	20
50	2	30	20
51	3	30	20
52	4	30	20
53	5	30	20
54	6	30	20
55	7	30	20
56	8	30	20
57	9	30	20
58	:	18	12
59	::	18	12
60	<	30	20
61	=	30	20
62	>	30	20
63	?	30	20
64	@	36	24
65	A	36	24
66	B	36	24
67	C	36	24
68	D	36	24
69	E	36	24
70	F	36	24
71	G	36	24
72	H	36	24
73	I	24	16
74	J	30	20
75	K	36	24
76	L	36	24
77	M	42	28
78	N	36	24
79	O	36	24
80	P	36	24
81	Q	36	24
82	R	36	24
83	S	36	24
84	T	36	24
85	U	42	28
86	V	36	24
87	W	42	28

ASCII code	Char.	Width	
		Normal	Script
88	X	36	24
89	Y	36	24
90	Z	30	20
91	[24	16
92	\	30	20
93]	24	16
94	^	30	20
95	_	30	24
96	`	18	12
97	a	30	20
98	b	36	24
99	c	30	20
100	d	36	24
101	e	30	20
102	f	24	16
103	g	36	24
104	h	36	24
105	i	18	12
106	j	24	16
107	k	36	24
108	l	18	12
109	m	42	28
110	n	36	24
111	o	30	20
112	p	36	24
113	q	36	24
114	r	30	20
115	s	30	20
116	t	24	16
117	u	36	24
118	v	36	24
119	w	42	28
120	x	30	20
121	y	36	24
122	z	30	20
123	{	24	16
124		18	12
125	}	24	16
126	~	30	20
127	ø	30	20

Unit: 1/360 inch (0.07 mm)

Appendix B

IBM Proprinter X24 mode characters

ASCII code	Char.	Width	
		Normal	Script
32	SPACE	30	
33	!	30	
34	"	30	
35	#	30	
36	\$	30	
37	%	30	
38	&	36	
39	'	18	
40	(30	
41)	30	
42	*	30	
43	+	30	
44	,	30	
45	-	30	
46	.	30	
47	/	30	
48	0	30	
49	1	30	
50	2	30	
51	3	30	
52	4	30	
53	5	30	
54	6	30	
55	7	30	
56	8	30	
57	9	30	
58	:	30	
59	;	30	
60	<	30	
61	=	30	
62	>	30	
63	?	30	
64	@	30	
65	A	42	
66	B	42	
67	C	42	
68	D	42	
69	E	36	
70	F	36	
71	G	42	
72	H	42	
73	I	24	
74	J	30	
75	K	42	

ASCII code	Char.	Width	
		Normal	Script
76	L	36	
77	M	42	
78	N	42	
79	O	42	
80	P	36	
81	Q	42	
82	R	42	
83	S	36	
84	T	42	
85	U	42	
86	V	42	
87	W	42	
88	X	42	
89	Y	42	
90	Z	36	
91	[30	
92	\	30	
93]	30	
94	^	30	
95	_	30	
96	`	30	
97	a	30	
98	b	36	
99	c	30	
100	d	36	
101	e	30	
102	f	24	
103	g	36	
104	h	36	
105	i	18	
106	j	18	
107	k	36	
108	l	18	
109	m	42	
110	n	36	
111	o	30	
112	p	36	
113	q	36	
114	r	30	
115	s	30	
116	t	24	
117	u	36	
118	v	36	
119	w	42	

ASCII code	Char.	Width	
		Normal	Script
120	x	36	
121	y	36	
122	z	30	
123	{	30	
124		30	
125	}	30	
126	~	30	

B

Unit: 1/360 inch (0.07 mm)

Appendix B

IBM Graphic Characters

Epson LQ-850 mode characters

ASCII code	Char.	Width	
		Normal	Script
21	§	30	20
128	Ç	36	24
129	ü	36	24
130	é	30	20
131	à	30	20
132	á	30	20
133	â	30	20
134	ã	30	20
135	ç	30	20
136	ê	30	20
137	ë	30	20
138	è	30	20
139	ï	18	12
140	í	18	12
141	ì	18	12
142	Ā	36	24
143	Ă	36	24
144	Ĕ	36	24
145	æ	42	28
146	Æ	42	28
147	ó	30	20
148	ô	30	20
149	õ	30	20
150	ù	36	24
151	ú	36	24
152	ÿ	36	24
153	Ŏ	36	24
154	Ū	42	28
155	ı	30	20
156	£	30	20
157	¥	36	24
158	ƒ	42	28
159	ƒ	30	20
160	á	30	20
161	í	18	12
162	ó	30	20
163	ù	36	24
164	ñ	36	24
165	Ñ	36	24
166	ä	30	20
167	ö	30	20
168	ž	30	20

ASCII code	Char.	Width	
		Normal	Script
169	┌	30	20
170	┐	30	20
171	└	30	20
172	┘	30	20
173	├	18	12
174	┤	30	20
175	┘	30	20
224	α	30	20
225	β	30	20
226	Γ	30	20
227	π	30	20
228	Σ	30	20
229	σ	30	20
230	μ	30	20
231	τ	30	20
232	φ	30	20
233	θ	30	20
234	Ω	30	20
235	δ	30	20
236	ε	36	24
237	φ	30	20
238	⌋	30	20
239	⌌	30	20
240	⌍	30	20
241	⌎	30	20
242	⌏	30	20
243	⌐	30	20
246	+	30	20
247	•	30	20
248	◦	30	20
249	•	30	20
250	•	30	20
251	√	30	20
252	∞	30	20
253	∞	30	20
254	■	30	20
255	SP	30	20

Unit: 1/360 inch (0.07 mm)

IBM Proprinter X24 mode characters

ASCII code	Char.	Width	
		Normal	Script
0	␣	30	
1	⊙	30	
2	●	30	
3	♥	30	
4	♦	30	
5	♣	30	
6	♠	30	
7	•	30	
8	◻	30	
9	◊	30	
10	■	30	
11	♂	30	
12	♀	30	
13	♪	30	
14	β	30	
15	◦	30	
16	▶	30	
17	◀	30	
18	↑	30	
19	!!	30	
20	¶	30	
21	§	30	
22	—	30	
23	‡	30	
24	↑	30	
25	↓	30	
26	→	30	
27	←	30	
28	L	30	
29	↔	30	
30	▲	30	
31	▼	30	
127	△	30	
128	◊	42	
129	ū	36	
130	é	30	
131	à	30	
132	ä	30	
133	â	30	
134	â	30	
135	ç	30	
136	ê	30	
137	ë	30	
138	è	30	
139	ï	18	

ASCII code	Char.	Width	
		Normal	Script
140	ì	18	
141	í	18	
142	Ë	36	
143	À	36	
144	É	36	
145	æ	42	
146	Æ	42	
147	ð	30	
148	ö	30	
149	ó	30	
150	û	36	
151	ù	36	
152	ÿ	36	
153	Ö	36	
154	Ü	42	
155	q	30	
156	£	30	
157	¥	36	
158	Pts	42	
159	f	30	
160	á	30	
161	í	18	
162	ó	30	
163	ú	36	
164	ñ	36	
165	Ñ	36	
166	ß	30	
167	o	30	
168	ó	30	
169	┌	30	
170	┐	30	
171	└	30	
172	┘	30	
173	ı	30	
174	<<	42	
175	>>	42	
224	α	30	
225	β	36	
226	Γ	36	
227	π	36	
228	Σ	42	
229	σ	36	
230	μ	36	

ASCII code	Char.	Width	
		Normal	Script
231	τ	30	
232	Φ	42	
233	0	42	
234	Ω	42	
235	ð	30	
236	ø	30	
237	φ	42	
238	ε	30	
239	∩	30	
240	≡	30	
241	±	30	
242	∞	30	
243	∠	30	
246	+	30	
247	•	30	
248	◦	30	
249	•	30	
250	•	30	
251	√	30	
252	n	30	
253	²	30	
254	■	30	
255	SP	30	

Unit: 1/360 inch (0.07 mm)

Appendix C

Structure of an Index table entry

10 cpi draft font

Address	Data		
8010	40	815E	D7204A090000000000
8011	D3454A090000000000	8167	D73E4A090000000000
801A	D3634A090000000000	8170	D75C44090000000000
8023	D3814A090000000000	8179	D76847090000000000
802C	D39F4A090000000000	8182	D77D47090000000000
8035	D3BD4A090000000000	818B	D7924A090000000000
803E	D3DB4A090000000000	8194	D7B048090000000000
8047	D3F94A090000000000	819D	D7C846090000000000
8050	D417480900000000000	81A6	D7DA46090000000000
8059	D42F480900000000000	81AF	D7EC46090000000000
8062	D447480900000000000	81B8	D7FE4A090000000000
806B	D45F4A0900000000000	81C1	D81C48090000000000
8074	D47D480900000000000	81CA	D83446090000000000
807D	D4954A0900000000000	81D3	D8464A090000000000
8086	D4B34A0900000000000	81DC	D86448090000000000
808F	D4D14A0900000000000	81E5	D87C49090000000000
8098	D4EF4A0900000000000	81EE	D89749090000000000
80A1	D50D4A0900000000000	81F7	D8B249090000000000
80AA	D52B4A0900000000000	8200	D8CD49090000000000
80B3	D5494A0900000000000	8209	D8E848090000000000
80BC	D567490900000000000	8212	D90049090000000000
80C5	D582490900000000000	821B	D91B46090000000000
80CE	D59D480900000000000	8224	D92D46090000000000
80D7	D5B5460900000000000	822D	D93F4A090000000000
80E0	D5C74A0900000000000	8236	D95D46090000000000
80E9	D5E54A0900000000000	823F	D96F4A090000000000
80F2	D6034A0900000000000	8248	D98D4A090000000000
80FB	D621490900000000000	8251	D9AB4A090000000000
8104	D63C490900000000000	825A	D9C94A090000000000
810D	D657460900000000000	8263	D9E747090000000000
8116	D669480900000000000	826C	D9FC48090000000000
811F	D6814A0900000000000	8275	DA1447090000000000
8128	D69F4A0900000000000	827E	DA2947090000000000
8131	D6BD420900000000000	8287	DA3E47090000000000
813A	D6C3460900000000000	8290	DA534A090000000000
8143	D6D5460900000000000	8299	DA7145090000000000
814C	D6E7490900000000000	82A2	DA8048090000000000
8155	D7024A0900000000000	82AB	DA9847090000000000

C

Appendix C

82B4	DAAD49090000000000	842E	DEBB49090000000000
82BD	DAC846090000000000	8437	DED64A090000000000
82C6	DADA4A090000000000	8440	DEF44A090000000000
82CF	DAF84A090000000000	8449	DF124A090000000000
82D8	DB1648090000000000	8452	DF304A090000000000
82E1	DB2E47090000000000	845B	DF4E4A090000000000
82EA	DB434A090000000000	8464	DF6C48090000000000
82F3	DB6148090000000000	846D	DF8444090000000000
82FC	DB7948090000000000	8476	DF9048090000000000
8305	DB9146090000000000	847F	DFA84A090000000000
830E	DBA348090000000000	8488	DFC64A090000000000
8317	DBBB4A090000000000	8491	DFE44A090000000000
8320	DBD94A090000000000	849A	E00249090000000000
8329	DBF74A090000000000	84A3	E01D4A090000000000
8332	DC154A090000000000	84AC	E03B4A090000000000
833B	DC334A090000000000	84B5	E05949090000000000
8344	DC5146090000000000	84BE	E0744A090000000000
834D	DC634A090000000000	84C7	E0924A090000000000
8356	DC8146090000000000	84D0	E0B04A090000000000
835F	DC934A090000000000	84D9	E0CE4A090000000000
8368	D6BDC3890000000000	84E2	E0EC48090000000000
8371	DCB147090000000000	84EB	E1044A090000000000
837A	DC6480900000000000	84F4	E122490900000000000
8383	DCDE49090000000000	84FD	E13D4A090000000000
838C	DCF948090000000000	8506	E15B47090000000000
8395	DD1149090000000000	850F	E1704A090000000000
839E	DD2C48090000000000	8518	E18E4A090000000000
83A7	DD4448090000000000	8521	E1AC48090000000000
83B0	DD5C48090000000000	852A	E1C44A090000000000
83B9	DD7449090000000000	8533	E1E248090000000000
83C2	DD8F48090000000000	853C	E1FA4A090000000000
83CB	DDA749090000000000	8545	E21848090000000000
83D4	DDC24A090000000000	854E	E2304A090000000000
83DD	DDE046090000000000	8557	E24E4A090000000000
83E6	DDF249090000000000	8560	E26C4A090000000000
83EF	DE0D49090000000000	8569	E28A4A090000000000
83F8	DE2848090000000000	8572	E2A848090000000000
8401	DE4048090000000000	857B	E2C048090000000000
840A	DE5848090000000000	8584	E2D84A090000000000
8413	DE7049090000000000	858D	E2F64A090000000000
841C	DE8B48090000000000	8596	E3144A090000000000
8425	DEA348090000000000	859F	E332490900000000000

C

Appendix C

85A8	E34D4A090000000000	8722	E6CBC6490000000000
85B1	E36B4A090000000000	872B	E6DDC7490000000000
85BA	E38948090000000000	8734	E6F2C7490000000000
85C3	E3A14A090000000000	873D	E707C6490000000000
85CC	E3BF4A090000000000	8746	E719C3490000000000
85D5	E3DD4A090000000000	874F	E722C7490000000000
85DE	E3FB4A090000000000	8758	E737C5490000000000
85E7	E419490900000000000	8761	E746C7490000000000
85F0	E434480900000000000	876A	E75BC5490000000000
85F9	E44C4A090000000000	8773	E76AC7490000000000
8602	E46A46090000000000	877C	E77FC6490000000000
860B	E47C46090000000000	8785	E791C4490000000000
8614	E48E4A090000000000	878E	E79DC4490000000000
861D	E4AC4A090000000000	8797	E7A9C6490000000000
8626	E4CA46090000000000	87A0	E7BBC7490000000000
862F	E4DC4A090000000000	87A9	E7DOC5490000000000
8638	E4FA4A090000000000	87B2	E7DFC5490000000000
8641	E518C9090000000000	87BB	E7EEC4490000000000
864A	E533C8090000000000	87C4	E7FAC3490000000000
8653	E54BC9090000000000	87CD	E803C3490000000000
865C	E566C4490000000000	87D6	E80CC5490000000000
8665	E572C5490000000000	87DF	E81BC4490000000000
866E	E581C5490000000000	87E8	E827C3490000000000
8677	E590C7490000000000	87F1	E8304A090000000000
8680	E5A5C7490000000000	87FA	E84E4A090000000000
8689	E5BAC5490000000000	8803	E86C46090000000000
8692	E5C9C7490000000000	880C	E87E48090000000000
869B	E5DEC6490000000000	8815	E89649090000000000
86A4	E5F0C7490000000000	881E	E8B148090000000000
86AD	E605C7490000000000	8827	E8C9A0900000000000
86B6	E61AC7490000000000	8830	E8E748090000000000
86BF	E62FC5490000000000	8839	E8FF4A090000000000
86C8	E63EC5490000000000	8842	E91D48090000000000
86D1	E64DC4490000000000	884B	E93548090000000000
86DA	E659C5490000000000	8854	E94D48090000000000
86E3	E668C5490000000000	885D	E9654A090000000000
86EC	E677C4490000000000	8866	E9834A090000000000
86F5	E683C3490000000000	886F	E9A149090000000000
86FE	E68CC5490000000000	8878	E9BC49090000000000
8707	E69BC4490000000000	8881	E9D744090000000000
8710	E6A7C6490000000000	888A	E9E348090000000000
8719	E6B9C6490000000000	8893	E9FB4A090000000000

C

Appendix C

889C	EA194A090000000000
88A5	EA37C7490000000000
88AE	EA4C47090000000000
88B7	EA614A090000000000
88C0	EA7F4A090000000000
88C9	EA9D48090000000000
88D2	EAB548090000000000
88DB	EACD46090000000000
88E4	EADF4A090000000000
88ED	EAFD49090000000000
88F6	EB1849090000000000
88FF	EB3346090000000000
8908	EB4542090000000000

10 cpi LQ font

Address	Data
8911	41
8912	A4145C230000000000
891B	A46859230000000000
8924	A4B35B230000000000
892D	A50459230000000000
8936	A54F5B230000000000
893F	A5A059230000000000
8948	A5EB5B230000000000
8951	A63C48230000000000
895A	A6544D230000000000
8963	A67B50230000000000
896C	A6AB4F230000000000
8975	A6D855230000000000
897E	A71750230000000000
8987	A74757230000000000
8990	A78C54230000000000
8999	A7C856230000000000
89A2	A80A4A230000000000
89AB	A8284A230000000000
89B4	A84656230000000000
89BD	A8884A230000000000
89C6	A8A64D230000000000
89CF	A8CD59230000000000
89D8	A91844230000000000
89E1	A92456230000000000
89EA	A96656230000000000
89F3	A9A856230000000000
89FC	A9EA4E230000000000
8A05	AA144E230000000000
8A0E	AA3E45230000000000
8A17	AA4D58230000000000
8A20	AA955A230000000000
8A29	AAE35A230000000000
8A32	AB3142230000000000
8A3B	AB3748230000000000
8A44	AB4F4E230000000000
8A4D	AB794E230000000000
8A56	ABA355230000000000
8A5F	ABE259230000000000
8A68	AC2D5A230000000000

C

Appendix C

8A71	AC7B48230000000000	8BEB	B45E5B230000000000
8A7A	AC934C230000000000	8BF4	B4AF53230000000000
8A83	ACB74C230000000000	8BFD	B4E857230000000000
8A8C	ACDB58230000000000	8C06	B52D4A230000000000
8A95	AD2346230000000000	8C0F	B54B50230000000000
8A9E	AD354D230000000000	8C18	B57B5C230000000000
8AA7	AD5C44230000000000	8C21	B5CF5E230000000000
8AB0	AD6846230000000000	8C2A	B62956230000000000
8AB9	AD7A5C230000000000	8C33	B66B58230000000000
8AC2	ADCE54230000000000	8C3C	B6B358230000000000
8ACB	AE0A4A230000000000	8C45	B6FB45230000000000
8AD4	AE2856230000000000	8C4E	B70A5C230000000000
8ADD	AE6A55230000000000	8C57	B75E45230000000000
8AE6	AEA954230000000000	8C60	B76D4C230000000000
8AEF	AEE551230000000000	8C69	AB31C2A30000000000
8AF8	AF1857230000000000	8C72	B79149230000000000
8B01	AF5D53230000000000	8C7B	B7AC53230000000000
8B0A	AF9654230000000000	8C84	B7E553230000000000
8B13	AFD257230000000000	8C8D	B81E56230000000000
8B1C	B01746230000000000	8C96	B86053230000000000
8B25	B0294E230000000000	8C9F	B89954230000000000
8B2E	B05350230000000000	8CA8	B8D54B230000000000
8B37	B08344230000000000	8CB1	B8F656230000000000
8B40	B08F50230000000000	8CBA	B93858230000000000
8B49	B0BF53230000000000	8CC3	B9804A230000000000
8B52	B0F855230000000000	8CCC	B99E4B230000000000
8B5B	B1375F230000000000	8CD5	B9BF58230000000000
8B64	B1944F230000000000	8CDE	BA074A230000000000
8B6D	B1C156230000000000	8CE7	BA2554230000000000
8B76	B2034F230000000000	8CF0	BA6155230000000000
8B7F	B23049230000000000	8CF9	BAA056230000000000
8B88	B24B49230000000000	8D02	BAE253230000000000
8B91	B26656230000000000	8D0B	B1B532300000000000
8B9A	B2A84A230000000000	8D14	BB544D230000000000
8BA3	B2C646230000000000	8D1D	BB7B56230000000000
8BAC	B2D84E230000000000	8D26	BBBD4F230000000000
8BB5	B302572300000000000	8D2F	BBEA54230000000000
8BBE	B34748230000000000	8D38	BC265A230000000000
8BC7	B35F5A230000000000	8D41	BC7460230000000000
8BD0	B3AD5B230000000000	8D4A	BCD458230000000000
8BD9	B3FE54230000000000	8D53	BD1C5D230000000000
8BE2	B43A4C230000000000	8D5C	BD735A230000000000

C

Appendix C

8D65	BDC14E230000000000	8EDF	C8475C230000000000
8D6E	BDEB44230000000000	8EE8	C89B55230000000000
8D77	BDF74E230000000000	8EF1	C8DA54230000000000
8D80	BE214E230000000000	8EFA	C91654230000000000
8D89	BE4B5C230000000000	8F03	C95245230000000000
8D92	BE9F5A230000000000	8F0C	C96145230000000000
8D9B	BEED56230000000000	8F15	C97051230000000000
8DA4	BF2F58230000000000	8F1E	C9A350230000000000
8DAD	BF7756230000000000	8F27	C9D348230000000000
8DB6	BFB955230000000000	8F30	C9EB58230000000000
8DBF	BFF856230000000000	8F39	CA3358230000000000
8DC8	C03A57230000000000	8F42	CA7BC9230000000000
8DD1	C07F55230000000000	8F4B	CA96C9230000000000
8DDA	C0BE56230000000000	8F54	CAB1C9230000000000
8DE3	C10055230000000000	8F5D	CACCC4630000000000
8DEC	C13F59230000000000	8F66	CAD8C4630000000000
8DF5	C18A50230000000000	8F6F	CAE4C4630000000000
8DFE	C1BA52230000000000	8F78	CAF0C6630000000000
8E07	C1F04C230000000000	8F81	CB02C6630000000000
8E10	C2145E230000000000	8F8A	CB14C4630000000000
8E19	C26E5E230000000000	8F93	CB20C6630000000000
8E22	C2C84E230000000000	8F9C	CB32C6630000000000
8E2B	C2F258230000000000	8FA5	CB44C6630000000000
8E34	C33A55230000000000	8FAE	CB56C6630000000000
8E3D	C37958230000000000	8FB7	CB68C6630000000000
8E46	C3C156230000000000	8FC0	CB7AC4630000000000
8E4F	C4035A230000000000	8FC9	CB86C4630000000000
8E58	C45156230000000000	8FD2	CB92C4630000000000
8E61	C49358230000000000	8FDB	CB9EC4630000000000
8E6A	C4DB5C230000000000	8FE4	CBAAC4630000000000
8E73	C52F58230000000000	8FED	CBB6C4630000000000
8E7C	C57752230000000000	8FF6	CBC2C2630000000000
8E85	C5AD51230000000000	8FFF	CBC8C4630000000000
8E8E	C5E057230000000000	9008	CBD4C4630000000000
8E97	C6255A230000000000	9011	CBE0C6630000000000
8EA0	C6735B230000000000	901A	CBF2C6630000000000
8EA9	C6C454230000000000	9023	CC04C6630000000000
8EB2	C70057230000000000	902C	CC16C6630000000000
8EBB	C7454E230000000000	9035	CC28C6630000000000
8EC4	C76F5B230000000000	903E	CC3AC6630000000000
8ECD	C7C057230000000000	9047	CC4CC2630000000000
8ED6	C80556230000000000	9050	CC52C6630000000000

C

Appendix C

9059	CC64C4630000000000
9062	CC70C6630000000000
906B	CC82C4630000000000
9074	CC8EC6630000000000
907D	CCA0C6630000000000
9086	CCB2C4630000000000
908F	CCBEC4630000000000
9098	CCCAC6630000000000
90A1	CCDCC6630000000000
90AA	CCEEC4630000000000
90B3	CCFAC4630000000000
90BC	CD06C4630000000000
90C5	CD12C2630000000000
90CE	CD18C2630000000000
90D7	CD1EC3630000000000
90E0	CD27C3630000000000
90E9	CD30C2630000000000
90F2	CD365E230000000000
90FB	CD905A230000000000
9104	CDDE48230000000000
910D	CDF650230000000000
9116	CE2655230000000000
911F	CE6554230000000000
9128	CEA152230000000000
9131	CED74F230000000000
913A	CF0452230000000000
9143	CF3A58230000000000
914C	CF825A230000000000
9155	CFD056230000000000
915E	D01255230000000000
9167	D05158230000000000
9170	D09951230000000000
9179	D0CC52230000000000
9182	D102442300000000000
918B	D10E46230000000000
9194	D12050230000000000
919D	D150502300000000000
91A6	D180CF630000000000
91AF	D1AD4E230000000000
91B8	D1D748230000000000
91C1	D1EF50230000000000
91CA	D21E52230000000000

91D3	D25548230000000000
91DC	D26D46230000000000
91E5	D27F5E230000000000
91EE	D2D951230000000000
91F7	D30C4D230000000000
9200	D33344230000000000
9209	D33F42230000000000

C

Appendix C

Proportional Spacing LQ font

Address	Data
9212	43
9213	EB4B5B1D0000000000
921C	A468581D0000000000
9225	A4B35A1D0000000000
922E	A504581D0000000000
9237	A54F5B1D0000000000
9240	A5A0591D0000000000
9249	A5EB5B1D0000000000
9252	A63C481D0000000000
925B	A6544C1D0000000000
9264	A67B501D0000000000
926D	A6AB4E1D0000000000
9276	A6D8551D0000000000
927F	A717501D0000000000
9288	A747561D0000000000
9291	A78C531D0000000000
929A	A7C8551D0000000000
92A3	A80A4A1D0000000000
92AC	A8284A1D0000000000
92B5	A846561D0000000000
92BE	EB9C4A1D0000000000
92C7	EBBA4E1D0000000000
92D0	EBE4581D0000000000
92D9	A918441D0000000000
92E2	A924561D0000000000
92EE	A966561D0000000000
92F4	A9A8561D0000000000
92FD	A9EA4D1D0000000000
9306	AA144E1D0000000000
930F	AA3E451D0000000000
9318	AA4D581D0000000000
9321	AA955A1D0000000000
932A	AAE35A1D0000000000
9333	EC2C421D0000000000
933C	EC32481D0000000000
9345	EC4A4E1D0000000000
934E	EC744E1D0000000000
9357	EC9E551D0000000000
9360	ECDD521D0000000000
9369	ED135A230000000000

9372	ED6148110000000000
937B	ED794C1D0000000000
9384	ED9D4C1D0000000000
938D	EDC1581D0000000000
9396	AD23461D0000000000
939F	EE094D1D0000000000
93A8	EE30441D0000000000
93B1	EE3C461D0000000000
93BA	EE4E5B1D0000000000
93C3	EE9F541D0000000000
93CC	EEDB4A1D0000000000
93D5	EEF9561D0000000000
93DE	EF3B531D0000000000
93E7	EF74531D0000000000
93F0	EFAD541D0000000000
93F9	EFE9571D0000000000
9402	F02E521D0000000000
940B	F064541D0000000000
9414	F0A0571D0000000000
941D	E0E5461D0000000000
9426	E0F74D1D0000000000
942F	B053501D0000000000
9438	B083441D0000000000
9441	B08F501D0000000000
944A	F11E531D0000000000
9453	F157551D0000000000
945C	F19660290000000000
9465	F1F652290000000000
946E	F22C58290000000000
9477	F27452290000000000
9480	F2AA49230000000000
9489	F2C54B230000000000
9492	F2E659290000000000
949B	F3314E290000000000
94A4	F35B46170000000006
94AD	F36D4E1D0000000000
94B6	F3975C290000000000
94BF	F3EB48230000000000
94C8	F4035E290000000000
94D1	F45D5D290000000000
94DA	F4B45A290000000000
94E3	F5024E230000000000

C

Appendix C

94EC	F52C5E290000000000	9666	FEB64E1D0000000000
94F5	F58655290000000000	966F	FEE0441D0000000000
94FE	F5C554230000000000	9678	FEEC4E1D0000000000
9507	F6014E290000000000	9681	FE164E1D0000000000
9510	F62B5C290000000000	968A	BE4B5C1D0000000000
9519	F67F61290000000000	9693	EF405B290000000000
9522	F6E261290000000000	969C	4FFF56230000000000
952B	F74564290000000000	96A5	5041591D0000000000
9534	F7B159290000000000	96AE	508C571D0000000000
953D	F7FC59230000000000	96B7	50D1541D0000000000
9546	F847451D0000000000	96C0	510D571D0000000000
954F	F8565B1D0000000000	96C9	5152551D0000000000
9558	F8A7451D0000000000	96D2	5191561D0000000000
9561	F8B64E1D0000000000	96DB	51D3571D0000000000
956A	AB31C29D0000000000	96E4	5218551D0000000000
9573	F8E0491D0000000000	96ED	5257581D0000000000
957C	F8FB531D0000000000	96F6	529F4B110000000000
9585	F93452230000000000	96FF	52C04E110000000000
958E	F96A531D0000000000	9708	52EA4A110000000000
9597	F9A353230000000000	9711	530862290000000000
95A0	F9DC541D0000000000	971A	536E60290000000000
95A9	FA184C170000000000	9723	53CE4F230000000000
95B2	FA3C53230000000000	972C	53FB5D290000000000
95BB	FA7556230000000000	9735	545259290000000000
95C4	FAB745110000000000	973E	549D581D0000000000
95CD	FAC64B110000000000	9747	54E5541D0000000000
95D6	FAE753230000000000	9750	5521581D0000000000
95DF	FB2046110000000000	9759	556957230000000000
95E8	FB3258290000000000	9762	55AE56230000000000
95F1	FB7A53230000000000	976B	5F05D2300000000000
95FA	EBB3541D0000000000	9774	56475B290000000000
9603	FBEF53230000000000	977D	569859290000000000
960C	FC2853230000000000	9786	56E3551D0000000000
9615	FC61501D0000000000	978F	5722551D0000000000
961E	FC91521D0000000000	9798	5761581D0000000000
9627	ECC749170000000000	97A1	57A95F290000000000
9630	ECE254230000000000	97AA	5806531D0000000000
9639	FD1E5A230000000000	97B3	583F571D0000000000
9642	FD6C61290000000000	97BC	588449110000000000
964B	FDCF58230000000000	97C5	589F591D0000000000
9654	FE175D230000000000	97CE	58EA57230000000000
965D	FE6E581D0000000000	97D7	592F56230000000000

C

Appendix C

97E0	597160290000000000	995A	CC64C45D0000000000
97E9	59D1551D0000000000	9963	CC70C65D0000000000
97F2	5A10541D0000000000	996C	CC82C45D0000000000
97FB	5A4C531D0000000000	9975	CC8EC65D0000000000
9804	C952451D0000000000	997E	CCA0C65D0000000000
980D	C961451D0000000000	9987	CCB2C45D0000000000
9816	5A85511D0000000000	9990	CCBEC45D0000000000
981F	5AB8501D0000000000	9999	CCCAC65D0000000000
9828	5AE8481D0000000000	99A2	CCDCC65D0000000000
9831	5B005A290000000000	99AB	CCEEC45D0000000000
983A	5B4E5A290000000000	99B4	CCFAC45D0000000000
9843	7C09C51D0000000000	99BD	CD06C45D0000000000
984C	7C18C51D0000000000	99C6	CD12C25D0000000000
9855	7C27C31D0000000000	99CF	CD18C25D0000000000
985E	CACCC45D0000000000	99D8	CD1EC35D0000000000
9867	CAD8C45D0000000000	99E1	CD27C35D0000000000
9870	CAE4C45D0000000000	99EA	CD30C25D0000000000
9879	CAF0C65D0000000000	99F3	5B9C5E1D0000000000
9882	CB02C65D0000000000	99FC	5BF65A230000000000
988B	CB14C45D0000000000	9A05	5C4448230000000000
9894	CB20C65D0000000000	9A0E	5C5C50230000000000
989D	CB32C65D0000000000	9A17	5C8C5A290000000000
98A6	CB44C65D0000000000	9A20	5CDA54230000000000
98AF	CB56C65D0000000000	9A29	5D1652230000000000
98B8	CB68C65D0000000000	9A32	5D4C4D1D0000000000
98C1	CB7AC45D0000000000	9A3B	5D7356290000000000
98CA	CB86C45D0000000000	9A44	5DB55A290000000000
98D3	CB92C45D0000000000	9A4D	5E035A290000000000
98DC	CB9EC45D0000000000	9A56	5E51561D0000000000
98E5	CBAAC45D0000000000	9A5F	D012541D0000000000
98EE	CBB6C45D0000000000	9A68	5E9358290000000000
98F7	CBC2C25D0000000000	9A71	5EDB511D0000000000
9900	CBC8C45D0000000000	9A7A	D0CC521D0000000000
9909	CBD4C45D0000000000	9A83	D102441D0000000000
9912	CBE0C65D0000000000	9A8C	D10E461D0000000000
991B	CBF2C65D0000000000	9A95	D120501D0000000000
9924	CC04C65D0000000000	9A9E	D150501D0000000000
992D	CC16C65D0000000000	9AA7	D180CF5D0000000000
9936	CC28C65D0000000000	9AB0	D1AD4E1D0000000000
993F	CC3AC65D0000000000	9AB9	D1D7481D0000000000
9948	CC4CC25D0000000000	9AC2	D1EF501D0000000000
9951	CC52C65D0000000000	9ACB	D21F521D0000000000

C

Appendix C

9AD4	D255481D0000000000
9ADD	D26D461D0000000000
9AE6	D27F5E1D0000000000
9AEF	5F0E511D0000000000
9AF8	5F414D1D0000000000
9B01	D333441D0000000000
9B0A	5F68421D0000000000

12 cpi LQ font

Address	Data
9B13	02
9B14	5F6E581D0000000000
9B1D	A468581D0000000000
9B26	A4B35A1D0000000000
9B2F	A504581D0000000000
9B38	A54F5B1D0000000000
9B41	A5A0591D0000000000
9B4A	A5EB5B1D0000000000
9B53	A63C481D0000000000
9B5C	A6544C1D0000000000
9B65	A67B501D0000000000
9B6E	A6AB4E1D0000000000
9B77	A6D8551D0000000000
9B80	A717501D0000000000
9B89	A747561D0000000000
9B92	A78C531D0000000000
9B9B	A7C8551D0000000000
9BA4	A80A4A1D0000000000
9BAD	A8284A1D0000000000
9BB6	A846561D0000000000
9BBF	5FB64E1D0000000000
9BC8	5FE04D1D0000000000
9BD1	6007531D0000000000
9BDA	A918441D0000000000
9BE3	A924561D0000000000
9BEC	A966561D0000000000
9BF5	A9A8561D0000000000
9BFE	A9EA4D1D0000000000
9C07	AA144E1D0000000000
9C10	AA3E451D0000000000
9C19	AA4D581D0000000000
9C22	AA955A1D0000000000
9C2B	AAE35A1D0000000000
9C34	AB31421D0000000000
9C3D	6040481D0000000000
9C46	60584E1D0000000000
9C4F	6082551D0000000000
9C58	60C1541D0000000000
9C61	60FD5C1D0000000000

C

Appendix C

9C6A	6151591D0000000000	9DE4	681D4D1D0000000000
9C73	619C481D0000000000	9DED	6844551D0000000000
9C7C	61B44E1D0000000000	9DF6	6883501D0000000000
9C85	61DE4E1D0000000000	9DFE	68B3511D0000000000
9C8E	6208571D0000000000	9E08	68E64C1D0000000000
9C97	AD23461D0000000000	9E11	690A501D0000000000
9CA0	624D481D0000000000	9E1A	693A591D0000000000
9CA9	6265441D0000000000	9E23	69855C1D0000000000
9CB2	6271461D0000000000	9E2C	69D95A1D0000000000
9CBB	6283501D0000000000	9E35	6A27571D0000000000
9CC4	62B3501D0000000000	9E3E	6A6C581D0000000000
9CCD	62E3461D0000000000	9E47	6AB4451D0000000000
9CD6	62F5571D0000000000	9E50	6AC3501D0000000000
9CDF	633A4F1D0000000000	9E59	6AF3451D0000000000
9CE8	6367531D0000000000	9E62	6B024A1D0000000000
9CF1	63A04F1D0000000000	9E6B	AB31C29D0000000000
9CFA	63CD551D0000000000	9E74	6B204A1D0000000000
9D03	640C531D0000000000	9E7D	6B3E531D0000000000
9D0C	6445551D0000000000	9E86	6B77531D0000000000
9D15	6484551D0000000000	9E8F	6BB0521D0000000000
9D1E	64C3461D0000000000	9E98	6BE6501D0000000000
9D27	64D5481D0000000000	9EA1	6C16511D0000000000
9D30	B053501D0000000000	9EAA	6C494A1D0000000000
9D39	B083441D0000000000	9EB3	6C67561D0000000000
9D42	B08F501D0000000000	9EBC	6CA9521D0000000000
9D4B	64ED511D0000000000	9EC5	6CDF4B1D0000000000
9D54	6520571D0000000000	9ECE	6D004D1D0000000000
9D5D	65655C1D0000000000	9ED7	6D27561D0000000000
9D66	65B94D1D0000000000	9EE0	6D69481D0000000000
9D6F	65E0501D0000000000	9EE9	6D81521D0000000000
9D78	66104E1D0000000000	9EF2	6DB7521D0000000000
9D81	663A4B1D0000000000	9EFB	6DED521D0000000000
9D8A	665B4A1D0000000000	9F04	6E234F1D0000000000
9D93	6679511D0000000000	9F0D	6E50501D0000000000
9D9C	66AC4A1D0000000000	9F16	6E80531D0000000000
9DA5	66CA481D0000000000	9F1F	6EB9501D0000000000
9DAE	66E24E1D0000000000	9F28	6EE94A1D0000000000
9DB7	670C531D0000000000	9F31	6F07501D0000000000
9DC0	67454A1D0000000000	9F3A	6F37591D0000000000
9DC9	6763581D0000000000	9F43	6F825E1D0000000000
9DD2	67AB561D0000000000	9F4C	6FDC571D0000000000
9DDB	67ED501D0000000000	9F55	70215A1D0000000000

C

Appendix C

9F5E	706F591D0000000000	A0D8	79DB561D0000000000
9F67	70BA4A1D0000000000	A0E1	7A1D581D0000000000
9F70	70D8441D0000000000	A0EA	7A65541D0000000000
9F79	70E44A1D0000000000	A0F3	7AA1501D0000000000
9F82	71024D1D0000000000	A0FC	7AD1501D0000000000
9F8B	BE4B5C1D0000000000	A105	C952451D0000000000
9F94	7129561D0000000000	A10E	C961451D0000000000
9F9D	716B531D0000000000	A117	7B01521D0000000000
9FA6	71A4561D0000000000	A120	7B37511D0000000000
9FAF	71E6561D0000000000	A129	7B6A481D0000000000
9FB8	7228571D0000000000	A132	7B82561D0000000000
9FC1	726D571D0000000000	A13B	7BC4571D0000000000
9FCA	72B2561D0000000000	A144	7C09C51D0000000000
9FD3	72F4561D0000000000	A14D	7C18C51D0000000000
9FDC	7336531D0000000000	A156	7C27C31D0000000000
9FE5	736F531D0000000000	A15F	CACCC45D0000000000
9FEE	73A8531D0000000000	A168	CAD8C45D0000000000
9FF7	73E14E1D0000000000	A171	CAE4C45D0000000000
A000	740B4D1D0000000000	A17A	CAF0C65D0000000000
A009	74324D1D0000000000	A183	CB02C65D0000000000
A012	74595B1D0000000000	A18C	CB14C45D0000000000
A01B	74AA571D0000000000	A195	CB20C65D0000000000
A024	74EF531D0000000000	A19E	CB32C65D0000000000
A02D	7528591D0000000000	A1A7	CB44C65D0000000000
A036	7573541D0000000000	A1B0	CB56C65D0000000000
A03F	75AF541D0000000000	A1B9	CB68C65D0000000000
A048	75EB521D0000000000	A1C2	CB7AC45D0000000000
A051	7621571D0000000000	A1CB	CB86C45D0000000000
A05A	7666531D0000000000	A1D4	CB92C45D0000000000
A063	769F561D0000000000	A1DD	CB9EC45D0000000000
A06C	76E1581D0000000000	A1E6	CBAAC45D0000000000
A075	7729521D0000000000	A1EF	CBB6C45D0000000000
A07E	775F541D0000000000	A1F8	CBC2C25D0000000000
A087	779B511D0000000000	A201	CBC8C45D0000000000
A090	77CE581D0000000000	A20A	CBD4C45D0000000000
A099	78165C1D0000000000	A213	CBE0C65D0000000000
A0A2	786A561D0000000000	A21C	CBF2C65D0000000000
A0AB	78AC541D0000000000	A225	CC04C65D0000000000
A0B4	78E8571D0000000000	A22E	CC16C65D0000000000
A0BD	792D4E1D0000000000	A237	CC28C65D0000000000
A0C6	7957571D0000000000	A240	CC3AC65D0000000000
A0CF	799C551D0000000000	A249	CC4CC25D0000000000

C

Appendix C

A252	CC52C65D0000000000
A25B	CC64C45D0000000000
A264	CC70C65D0000000000
A26D	CC82C45D0000000000
A276	CC8EC65D0000000000
A27F	CCA0C65D0000000000
A288	CCB2C45D0000000000
A291	CCBEC45D0000000000
A29A	CCCAC65D0000000000
A2A3	CCDCC65D0000000000
A2AC	CCEEC45D0000000000
A2B5	CCFAC45D0000000000
A2BE	CD06C45D0000000000
A2C7	CD12C25D0000000000
A2D0	CD18C25D0000000000
A2D9	CD1EC35D0000000000
A2E2	CD27C35D0000000000
A2EB	CD30C25D0000000000
A2F4	7C30581D0000000000
A2FD	7C78551D0000000000
A306	7CB7481D0000000000
A30F	7CCF501D0000000000
A318	7CFF521D0000000000
A321	7D35531D0000000000
A32A	7D6E571D0000000000
A333	7DB3511D0000000000
A33C	7DE6501D0000000000
A345	7E16541D0000000000
A34E	7E52541D0000000000
A357	7E8E541D0000000000
A360	D012541D0000000000
A369	7ECA561D0000000000
A372	7F0C501D0000000000
A37B	D0CC521D0000000000
A384	D102441D0000000000
A38D	D10E461D0000000000
A396	D120501D0000000000
A39F	D150501D0000000000
A3A8	D180CF5D0000000000
A3B1	D1AD4E1D0000000000
A3BA	D1D7481D0000000000
A3C3	D1EF501D0000000000

A3CC	D21F521D0000000000
A3D5	D255481D0000000000
A3DE	D26D461D0000000000
A3E7	D27F5E1D0000000000
A3F0	7F3C501D0000000000
A3F9	7F6C4E1D0000000000
A402	D333441D0000000000
A40B	7F96421D0000000000

C

Appendix D

Download Character Matrix Blanks: Draft

24 x 11

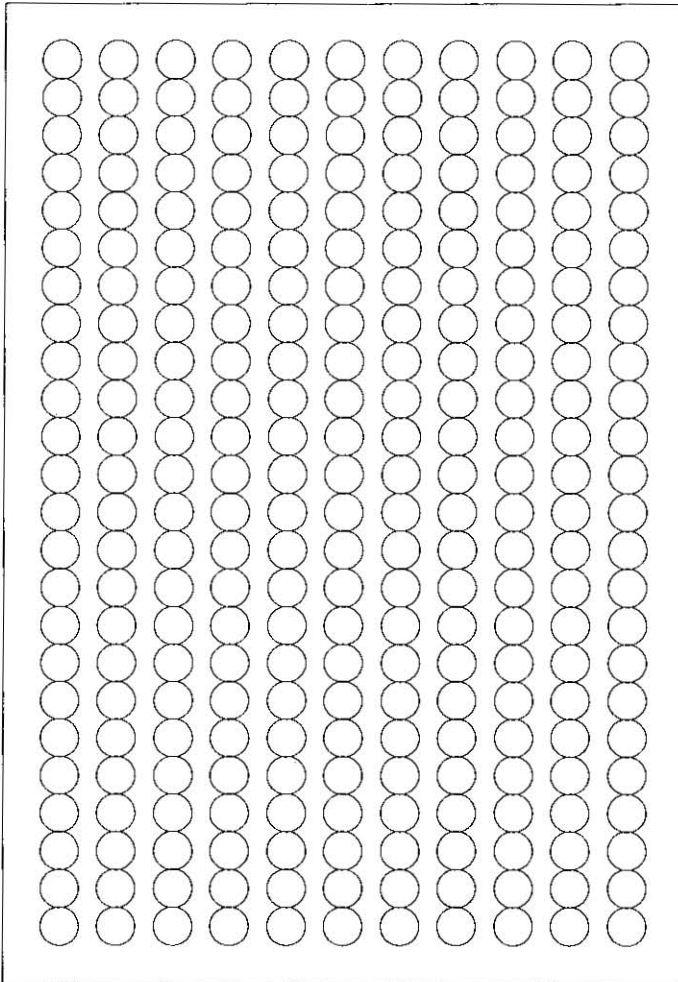

D

Make copies of this page first.
Then use blank matrices to design your download characters.

D-1 Appendix D

Download Character Matrix Blank: LQ

24 x 37

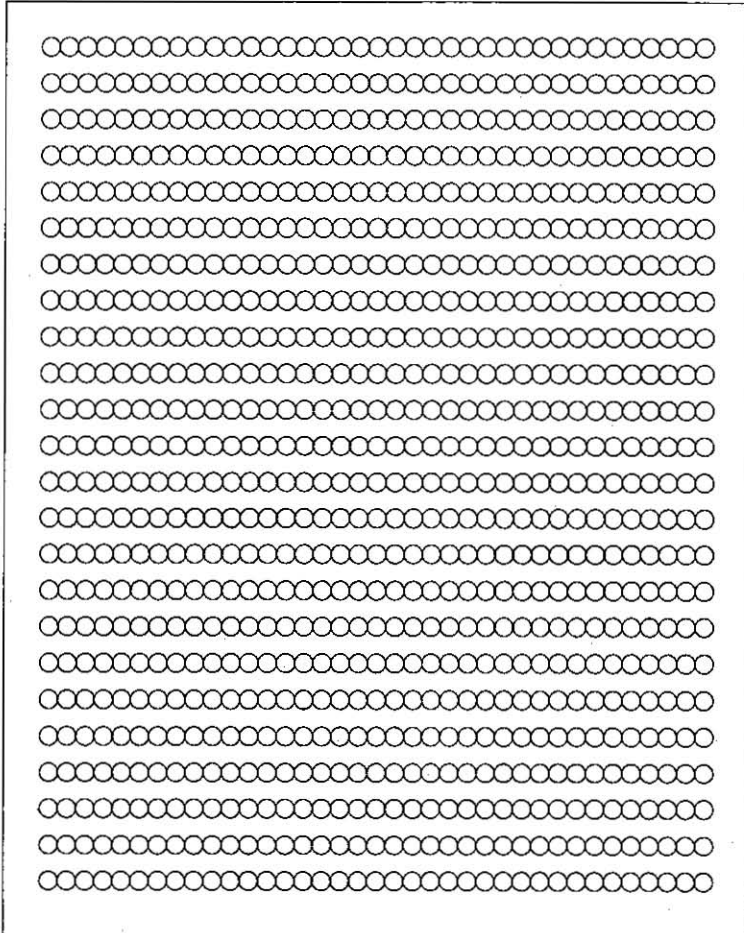

D

Make copies of this page first.
Then use blank matrices to design your download characters.

Appendix E

Paper Specifications

Paper which may be used with this unit must be within the specifications provided below.

1. Fanfold paper

Width: 4~10 inches (102~254 mm)

Quality and number of sheets:

*only for the last sheet

Type of paper	Sheets	Weight			
		in lbs		in g/m ²	
		push	pull	push	pull
Fine-quality paper	1	16~24	14~24	60~90	53~90
Non-carbon	2~4	11~14(17*)		41~53(64*)	
Multi-layered with carbon	2	11~14(17*)		41~53(64*)	

Note:

- When using multi-part fanfold paper especially in environments which have very high or low temperature and/or humidity, we recommend the use of the bottom feed pull mode to optimize paper handling and print quality.
- To insure optimum print quality, 16~22 lbs (60~83 g/m²) is recommended for graphic printing.
- In multi-layered paper with carbon, the carbon is equivalent to a sheet of paper.
- “Weight in pounds” represents the weight of 500 [17×22 inches (432×559 mm)] sheets.
- The printer will handle multipart papers up to 0.013 inch (0.32 mm). Up to 4 copies of 14 lb. chemical release paper can be used.
- When using multipart forms, rear feeding can be used up to 2 part forms. For 3 or 4 part forms, we recommend bottom feeding for optimum print quality.

E

2. Single Sheet

Width: 4~11.7 inches (102~297 mm)

Height: 5~14.3 inches (127~363 mm)

Weight in pounds (g/m²): 14~24 (53~90 g/m²)

Note:

- Paper should be within operating temperature and humidity ranges at least 24 hours prior to use.

3. Envelope

#6 and #10 size envelopes are recommended. Since envelopes vary in size, paper weight and construction, we cannot guarantee print quality and paper handling for all types of envelopes.

Note:

- To optimize print quality printing should not occur in areas where the edges overlap.

Appendix F

Printing Area

1. Continuous paper

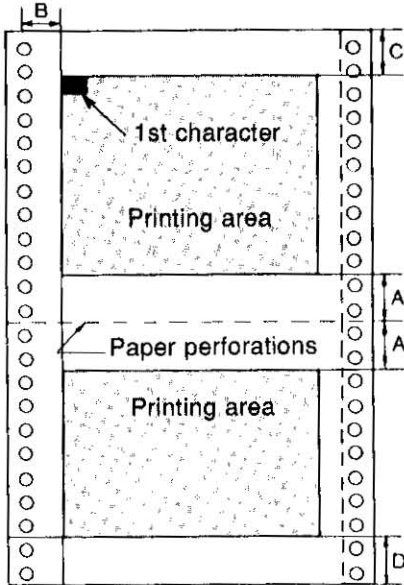

	Push	Pull
A	1"(25.4 mm)	
B	0.7"(17.8 mm)	
C	0.7"(17.8 mm)	5.4"(137 mm)
D	1"(25.4 mm)	

- A:** Value A indicates the area near the paper perforations where the quality may not be optimum.
- B:** Value B indicates the maximum distance between the sprockets and first printable character. (When the left tractor is set on the left end and the margin is set to 0.)
- C:** Value C indicates the area from the top edge of the paper to the top of the first printed character.
- D:** Value D indicates the position where paper out is detected and printing may not be optimum.

2. Single sheet and Envelope

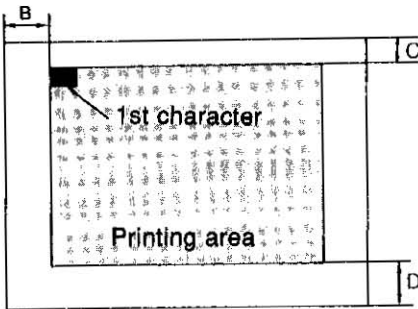

Single Sheet and Envelopes	
B	1.5"(38 mm)
C	0.7"(17.8 mm)
D	1"(25.4 mm)

- B:** Value B indicates the minimum distance between the edge of the paper and the first printable character. (When the left paper guide is set to the left end and the margin is set to 0.)
- C:** Value C indicates the area from the top edge of the paper to the top of the first printed character.
- D:** Value D indicates the position where paper out is detected and printing may not be optimum. (When printing on envelopes do not print on area where edges overlap. Print quality may not be optimum.)

Appendix G

Glossary

ASCII:

“ASCII” is an acronym for “American Standard Code for Information Interchange”. In ASCII, each character has a unique code.

BASIC:

BASIC is a commonly used microcomputer programming language.

Baud (baud rate):

Baud is a unit of data transmission speed between computer devices. Can be, but not necessarily, equal to bits per second.

Bidirectional printing:

Processing speed is increased by bidirectional printing. That is, the printer prints right-to-left as well as in the normal left-to-right manner.

Binary:

Binary is a numbering system using the two digits of zero (0) and one (1).

Bit:

Bit is an abbreviation for “binary digit (0~1)”, and is the smallest unit of information used by a printer or computer.

Buffer:

Buffer is an area of memory which stores data temporarily.

Byte:

Byte is the unit of information used by a printer or computer. One byte is equivalent to eight (8) bits.

Character set:

Character set is the set of characters, numbers, and symbols available for printing.

Control codes:

Control codes are commands from the computer to the printer that are non-printable characters. They are used to control printer functions. See Control Codes on page 4-1.

Control Table:

Control Table is the table which is located on the EZ Set Operator Panel. It makes easy to select various features and combinations of printer functions with the front panel switches.

cpi:

“cpi” is an abbreviation for “characters per inch”, and means the maximum number of characters printed in one horizontal inch.

cpl:

“cpl” is an abbreviation for “characters per line”, and means the maximum number of characters printed on one line.

cps:

“cps” is an abbreviation for “characters per second”, and means the number of characters printed in one second.

CR (Carriage Return):

“CR” is a control code that returns the printhead to the left margin.

Decimal (Dec.):

Decimal is a numbering system composed of 10 digits 0, 1, 2, 3, 4, 5, 6, 7, 8 and 9.

Default:

Default has two meanings: one indicates the previously set condition or settings executed when the power is turned on, reset or initialized; and the other indicates the original settings when shipped from the factory (FACTORY settings).

Double strike printing:

Double printing is a print quality enhancing mode which uses a double strike with two passes of the printhead, feeding the paper 1/180" (0.14 mm) between the first and second pass (in Epson mode only).

Appendix G

Double high printing:

Double high printing makes the height of a character twice that of a normal one.

Double width printing:

Double width printing makes the width of a character twice that of a normal one.

Download character:

Download character is a character which the user can design. (See Chapter 5.)

Draft:

Draft is one of two print qualities available on this printer. Draft mode uses a minimum number of dots per character to maximize printing speed.

Emphasized printing:

Emphasized printing is a print quality enhancing mode done in one pass of the printhead at half speed, allowing horizontally adjacent dots to be printed producing a darker character.

Emulation:

Emulation means to operate like another printer.

KX-P1123 can emulate the Epson LQ-850 or the IBM Proprinter X24.

Escape (ESC) sequence:

“ESC” is a control code that begins most printer commands. The characters which follow the “ESC” are interpreted as the command, rather than characters to print.

Fanfold paper:

Fanfold paper has regularly sprocket holes on the left and right sides and pages are separated by a perforation between each sheet. May also be known as computer paper or tractor paper.

FF (Form Feed):

“FF” is a control code that advances the paper one page.

Font:

Font is a style and size of type designated by a family name.

FORTRAN:

FORTRAN is one of many programming languages. It is used primarily in scientific applications.

Hexadecimal:

Hexadecimal is a numbering system using the 16 digits, 0, 1, 2, 3, 4, 5, 6, 7, 8, 9, A, B, C, D, E and F.

Initialization:

Initialization means to reset the printer to the initial start up condition.

Interface:

Interface is the connection between the two separate systems, such as the computer and the printer. A parallel interface transfers data one character or code at a time, and a serial interface transfers data one bit at a time.

I/O:

"I/O" is the symbolic notation for "Input/Output".

LF (Line Feed):

"LF" is a control code that advances the paper one line.

LSB:

"LSB" is an acronym for "Least Significant Bit", and means the rightmost position in a binary number.

MACRO memory function:

This feature allows the printer to easily save (and recall) a particular combination of functions, evenh if the power is turned off.

MICRO LINE FEED:

MICRO LINE FEED function allows you to feed the paper by one micro line (1/216"). See page 3-12.

MSB:

"MSB" is an acronym for "Most Significant Bit", and means the leftmost position in a binary number.

Appendix G

Letter quality (LQ):

LQ is one of two print qualities available on this printer. LQ mode increases the number of dots per character to improve the print quality but decrease the printing speed.

OFF LINE:

OFF LINE is the condition in which the printer can not communicate with the computer.

ON LINE:

ON LINE is the condition in which the printer can communicate with the computer.

Overline printing:

Overline printing produces a continuous line above the characters, using the first pin of the printhead.

Parallel interface:

See interface on page G-3.

Parity:

Parity is a method for a computer and printer to check the accuracy of data transfer.

PASCAL:

PASCAL is an commonly used microcomputer programming language.

Perforation:

Perforation indicates the tear position on the fanfold paper. (See page F-1 in Appendix F.)

Pitch:

Pitch is the number of characters which will print in one inch. Pitch is equivalent to characters per inch (cpi).

Platen

Platen is the rubber roller which is a backing for the paper when printing.

Printer drivers:

Most of today's off the shelf software programs use printer drivers to control printer functions. These drivers contain the software codes your software program uses to access printer features. With the printer driver installed, you will seldom need to know any of the KX-P1123 commands.

Proportional spacing (PS):

Proportional spacing is a printing method of adjusting the space in which a character is printed.

Protocol:

Protocol is the set of rules permitting communication between a computer and printer when a serial interface (RS-232C) is used. It covers polarity, baud rate, parity, data length, start bit and stop bit.

QUIET mode:

QUIET mode is a helpful feature which reduces printing noise.

RAM:

RAM is an acronym for "Random Access Memory". It is the part of the printer's memory in which is stored data to be printed, control codes or download characters. RAM is cleared when the printer is turned off.

ROM:

ROM is an acronym for "Read Only Memory". It is the part of the printer's memory in which predefined characters and operating information for the printer are stored. ROM is not cleared when the printer is turned off.

Appendix G

Self test:

Self test is a method for testing the operation of the printer. See Self test on page 2-16.

Serial interface:

See interface on page G-3.

Shielded Cable:

Shielded cable is a cable wrapped with a special metal around its wires. This guards against radio interference.

Skip perforation:

Skip perforation means nothing is printed in a specified area before and after the page perforation.

String concatenation:

This is the joining of two or more bytes of data into a single command.

Top of Form:

Top of Form is the first line position on the paper. To align the Top of Form, see page 3-16.

Unidirectional printing:

The printer prints left-to-right only. Printing speed is slow compared with bidirectional printing. This print method permits better vertical alignment.

Index

Most software commands of Epson LQ-850 mode and IBM Proprinter X24 mode descriptions are not indexed here. For page references for Epson LQ-850 mode commands, see pages 6-1 through 6-5 in Section 6. For IBM Proprinter X24 mode commands, see pages 7-1 through 7-4 in Section 7.

A

Acknowledge ($\overline{\text{ACK}}$)	8-1,8-3
Alternate Graphic Mode (AGM)	3-19,5-22
ASCII	4-1,4-4~4-7,G-1
Automatic CR mode	3-22
Automatic LF mode	3-22

B

BASIC	4-4,G-1
Baud rate	3-23,G-1
Bi-Directional Printing	3-22,G-1
Bit image	5-16
8-Pin Bit Image	5-18
24-Pin Bit Image	5-21
Bold PS	5-1
Bottom feeding	2-10
Buffer	1-2,3-23,5-3,G-1
Buzzer	3-21

C

Cable	8-1
Center paper support	1-6
Character sets	1-3,G-1
Epson LQ-850 mode	A-1
IBM Proprinter X24 mode	A-4
International	A-7
Characters Per Line	1-3,5-1
Column indicator light	1-5
COLUMN switch	3-2
Compatibility	1-2

Compressed mode	5-1
Concatenation	4-6
Connecting	2-17
Control Code	4-1,G-2
Control Table	1-5,3-1,3-3,G-2
Copies	1-4
Courier	5-1
Cut Sheet Feeder mode	3-21

D

Decimal	4-1,G-2
Default settings	3-10,3-20,G-2
Data Length	3-21
Detectors	3-25
Overheat detector	3-25
Overload detector	3-25
Paper out detector	3-25
DIP switch	3-18
Download	5-3,5-4
Dot configuration	1-3
Dot density	5-17
Dot matrix	1-1,1-3
Double density graphics	5-17
Double high printing	3-5,5-2,G-3
Double strike printing	3-5,5-2,G-2
Double width printing	3-5,5-2,G-3
Download characters	5-3,G-3
designation	5-4
entering	5-6
compression mask	5-12
Draft	5-1,5-4,5-6,G-3
D.T.R.	3-23

Index

E

Elite 1-3,5-1
Emphasized printing 5-1,5-2,G-3
Emulation 1-3,G-3
Epson LQ-850 mode 3-20,5-14,6-1
Escape (ESC) 4-1,G-3
EZ Set Operator Panel 1-1, 1-5,3-1

F

FACTORY 3-10,3-20
Fanfold paper 1-4,2-6,E-1,G-3
FF switch 1-5,3-2,3-12,G-3
FONT 3-3,5-1,G-3
Form Feed 3-12
FORM LENGTH 3-3
Frame ground 1-7,8-4
Friction 2-4,2-13
FUNCTION switch 3-1

G

Graphics 5-16
 Standard density 5-17
 Double density 5-17
 Double speed, double density 5-17
 Quadruple density 5-17

H

Head gap lever 1-6,2-5
Head life 1-4
Hexadecimal 4-5,G-4
Hex Dump 3-27

I

IBM Proprinter 3-20,5-10,7-1
 X24 mode
Index table 5-10, 5-11
 Structure of C-1
 an Index table entry

Initialization 3-26,G-4
Initial Setup mode 3-18
Ink ribbon cassette 2-1,9-2
Interfacing 1-3,8-1,G-4
International Character Sets 3-20
Italic 5-1

K

Keyboard entry 4-4

L

LEFT/RIGHT MARGIN 3-6
LF switch 3-2,3-12
Line Feed 3-12
LOAD/PARK 3-14,3-15
LQ font 5-1,5-5,5-8,G-5

M

MACRO 3-7
 MACRO READ 3-8
 MACRO WRITE 3-7
Maintenance 9-1
MARGIN Set 3-6
MICRO LINE FEED 3-12
Micron 1-3,5-1
MSB 5-22,G-4
Multi-Byte control command 4-6

O

ON LINE switch	3-1
ON LINE indicator lights	3-1
Operating environment	2-1
Overheat detector	3-25
Overline printing	5-2,G-5
Overload detector	3-25

P

Paper	E-1
installation	2-6
specifications	1-3
Paper Feeding	3-12
Paper feed selector	1-6,2-5
Paper Installation	2-6
Paper out detector	3-25
Paper Parking	3-14
Paper thickness	1-4,2-5
Parallel Interface connector	1-7,8-1
Parity Control	3-23,G-5
Parts of the Printer	1-5
Perforation Cut	3-13
Platen	1-6
Pica	1-3,5-1
Pitch	1-3,5-1,G-5
Platen knob	1-6
Power Requirement	1-3
Power switch	1-5,2-2
Prestige	5-1
Prime Signal	3-26
Print Buffer	3-26
Print Direction	1-4,3-22
Print Font	3-3,5-1
Printer drivers	G-6
Printhead Gap Lever	2-5
Printhead Life	1-4

Print Pitch	1-3,3-3,5-1
Print Quality	5-1
Print Speed	1-3,1-2
Printer Emulation	3-16
Printing Area	F-1
PROGRAM mode	3-2
Proportional Spacing (PS)	5-1,5-2,G-6
Proportional Spacing Tables	B-1
Protocol select	3-23,3-24,G-6
Pull tractor	1-4,2-8,E-1,F-1
Push tractor	1-4,2-8,E-1,F-1

Q

Quadruple density graphics	5-17
QUIET mode	1-1,3-11,G-6

R

RAM	G-6
R.D.T.	3-23
Re-Inking Ribbon	9-2
Rear feeding	2-6
Receive buffer	3-23
Remaining buffer capacity (R.B.C.)	3-23,3-24
Reset	3-20
Resume Data Transfer (R.D.T.)	3-23
Reverse Micro Line Feed	3-12
Ribbon cassette	2-2,9-2
Ribbon mounting	2-2
RIGHT MARGIN setting	3-6,3-7
ROM	G-6
ROW indicator light	1-5
ROW switch	3-2,3-6,3-7,3-8,3-9
RS-232C serial interface	2-17

Index

S

- Script 5-1
- S.D.T. (Suspend Data Transfer) 3-23
- Self test 2-16,G-7
- Serial interface 1-3,3-23
- SET switch 3-1,3-3,3-5,3-6,
3-7,3-8,3-9,3-18
- Setup 2-1
- Signal polarity for DTR 3-23
- Single-Byte control command 4-5
- Single directional printing 1-3,3-22
(Unidirectional)
- Single sheet 2-13,E-2,F-2
- Site Requirements 2-1
- Skip perforation 3-22
- Software compatibility 1-2,1-3
- Smoked plastic cover 1-6, 2-2
- Software Command 4-1
 - Epson 6-1
 - IBM 7-1
- Specifications 1-3
- Standard density graphics 5-17
- String concatenation G-7
- Strobe Signal 8-3
- Subscript 5-1,5-9
- Superscript 5-1,5-9
- Suspend data transfer (S.D.T.) 3-23

T

- Thickness 1-4
- Top cover 1-6,1-7
- Top of form 3-16,G-7
- Tractor 1-6, 2-7, 2-10
 - Pull tractor 1-4, 2-8
 - Push tractor 1-4, 2-8
- Tractor clamping lever 2-7
- Troubleshooting 9-2

U

- Underline printing 5-1,5-2
- Unidirectional printing 1-4,3-22,G-7
(single)
- Unpacking 2-1

X

- X/ON-X/OFF 3-23

Z

- Zero Font mode 3-21

OPTIONS and SUPPLIES

- KX-PS10 RS-232C/Serial Interface Board (Type B in that manual)
- KX-P19 RS-232C/Current Loop Serial Interface Board
(Type B in that manual)
- KX-P37 Auto Cut Sheet Feeder (Single bin)
- KX-P43 32K Buffer Chip
- KX-P145 Ribbon Cassette (black)

Matsushita Electric Industrial Co., Ltd.
Central P.O. Box 288, Osaka 530-91, Japan

Made in U.K.

PJQX6160ZB C1090TJ0