

ST251/ST251R/ST277R Product Manual

**February 3, 1987
36035-001, Revision A**

920 Disc Drive, Scotts Valley, CA 95066-4544, USA
Telephone: 408/438-6550 • Telex: 176455 SEAGATE SCVL

 **Seagate**

Copyright Notice

This manual and all the material contained in it are copyrighted with all rights reserved. This manual may not be copied, in whole or in part, without written consent of Seagate Technology.

Seagate reserves the right to change, without notice, the specifications contained in this manual.

CONTENTS

1.0 SPECIFICATION SUMMARY	1-1
1.1 Drive Capacity	1-1
1.1.1 Unformatted Capacity	1-1
1.1.2 Formatted Capacity	1-1
1.1.3 Physical Organization	1-1
1.2 Access Time Definition and Timing	1-2
1.3 Step Pulse Period and Seek Method	1-2
1.4 Functional Specifications	1-3
1.5 Recording Methods	1-3
1.6 Physical Specifications	1-3
1.7 Reliability Specifications	1-4
1.7.1 Read Error Rates	1-4
1.7.1.1 Bit Jitter	1-4
1.7.2 Media Defects	1-4
1.7.2.1 ST251	1-5
1.7.2.2 ST251R	1-5
1.7.2.3 ST277R	1-5
1.8 Environmental Specifications	1-5
1.8.1 Ambient Temperature	1-5
1.8.1.1 ST251	1-5
1.8.1.2 ST251R/277R	1-5
1.8.2 Temperature Gradient	1-5
1.8.3 Relative Humidity	1-6
1.8.4 Altitude Limits	1-6
1.8.5 Shock and Vibration Specifications	1-6
1.8.5.1 Operating Shock	1-6
1.8.5.2 Operating Vibration	1-6
1.8.5.3 Nonoperating Shock	1-7
1.8.5.4 Nonoperating Vibration	1-7
1.9 DC Power Specifications	1-8
1.9.1 Input Noise Ripple and Frequency	1-10
1.9.2 UL/CSA Certification	1-10
1.10 FCC Certification	1-10
1.11 Mounting Requirements	1-11
1.11.1 Shock Mounting Recommendations	1-11

1.11.2 Handling Precautions	1-13
1.11.3 Shipping Zone	1-13
1.12 Auto-Truncation	1-13
1.13 Typical Drive Timing	1-14
2.0 DRIVE CONFIGURATION	2-1
2.1 Drive Configuration Shunt J7	2-1
2.2 Drive Select	2-2
2.2.1 Daisy-Chain/Radial Drive Configurations	2-2
2.3 Write Fault Latch Options: JP1 and J7	2-2
2.4 DC-Unsafe Option: JP2	2-3
2.5 Precompensation	2-3
2.6 Life-Test	2-3
APPENDIX A. MFM/RLL FORMAT EXAMPLE	A-1

LIST OF ILLUSTRATIONS

Figure 1. Typical +12 VDC Start-Up Current Profile	1-9
Figure 2. Typical Power-On Sequence	1-9
Figure 3. Drive Mounting Dimensions	1-12
Figure 4. Read/Write Timing	1-14
Figure 5. Buffered-Seek Timing	1-15
Figure 6. Auto-Truncation Timing	1-15
Figure 7. Host/Drive Interface Connectors	2-1

The latched operation has two configurations which are provided at the J7 shunt, pins 5-6.

1. **No jumper at J7:** The Write Fault signal can only be cleared by a power on/off cycle. Use of this option in conjunction with the DC-Unsafe option is not recommended.
2. **Pins 5-6 shorted at J7:** The Write Fault signal can be cleared by de-selecting the drive. When the drive is deselected, and the fault condition is corrected, the Write Fault signal will be false.

2.4 DC-UNSAFE OPTION: JP2

JP2 has two jumper pads, and when a jumper is installed, a DC-unsafe condition will cause a Write Fault to be sent to the interface. Use *Figure 7 on page 2-1* to locate JP2.

2.5 PRECOMPENSATION

The ST251/251R/277R do not require precompensation.

2.6 LIFE-TEST

This is a test function used during the manufacturing process and is not recommended for field use. When pins 7-8 of J7 are shorted, the stepper motor will continuously seek between Track 0 and the maximum cylinder and will ignore control signals sent via the interface.

2.2 DRIVE SELECT

The Drive Select line enables the controller to select and address the drive. Control cable interface options may use either a daisy-chain or radial configuration.

- Pins 15-16 shorted enables Drive Select 1
- Pins 13-14 shorted enables Drive Select 2
- Pins 11-12 shorted enables Drive Select 3
- Pins 9-10 shorted enables Drive Select 4

2.2.1 DAISY-CHAIN/RADIAL DRIVE CONFIGURATIONS

The ST251/251R/277R can be configured in either a daisy-chain or radial mode. The radial option is enabled by shorting pins 1 and 2 at J7. The resistor termination pack must remain installed on **any** radially configured drive.

In a daisy-chain configuration, the **last** drive in a chain must have the resistor termination pack installed.

2.3 WRITE FAULT LATCH OPTIONS: JP1 AND J7

These options allow the user to configure the Write Fault reset to specific system requirements.

JP1 has three jumper pads, and is located adjacent to the 34-pin J1 connector. *Figure 7 on page 2-1* illustrates JP1 and indicates pin-1. J7 is located midway between the PCB edge-connectors (see "2.1 Drive Configuration Shunt J7" on page 2-1).

STANDARD: 1 and 2 jumpered on JP1

Write Fault will be cleared when Write Gate is false. A Write Fault will only occur when Write Gate is true.

LATCHED: 2 and 3 jumpered on JP1

This option will maintain Write Fault true after Write Gate goes false and is recommended for controllers that do not edge-detect Write Fault.

INTRODUCTION

This manual supports the ST251/251R/277R disc drives. It supercedes and replaces the ST251 Product Manual, 36016-001, Rev. B.

2.0 DRIVE CONFIGURATION

The ST251/251R/277R may be configured for specific system requirements.

2.1 DRIVE CONFIGURATION SHUNT J7

J7 is a 16-pin right-angle shunt located midway between the J1 and J2 connectors. Use the provided shorting block(s) to enable the Drive Select line and any options. *Figure 7* illustrates J7 and indicates pin 1.

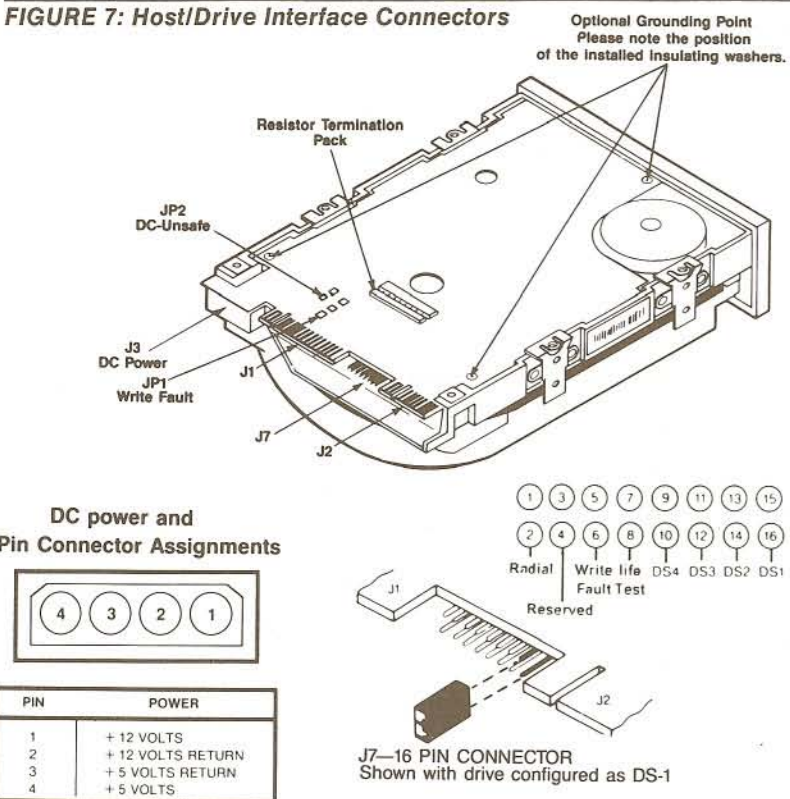

1.0 SPECIFICATION SUMMARY

1.1 DRIVE CAPACITY

1.1.1 UNFORMATTED CAPACITY

	ST251	ST251R	ST277R
Megabytes Per Drive:	51.2	51.2	76.9
Bytes Per Cylinder:	62,496	62,496	93,744
Bytes Per Track:	10,416	15,624	15,624

1.1.2 FORMATTED CAPACITY

Megabytes Per Drive:	42.8	43.6	65.5
Bytes Per Cylinder:	52,224	53,248	79,872
Bytes Per Track:	8,704	13,312	13,312
Bytes Per Sector:	512	512	512
Sectors per Track:	17	26	26

1.1.3 PHYSICAL ORGANIZATION

Tracks:	4,920	3,280	4,920
Cylinders:	820 (0-819)	820 (0-819)	820 (0-819)
Read/Write Heads:	6	4	6
Discs:	3	2	3

1.2 ACCESS TIME DEFINITION AND TIMING

Access time is defined as the time from the leading edge of the first step pulse received to Seek Complete (including settling). All seek times are true statistical averages and are calculated with a step pulse period of 10 μ sec. at nominal power and temperature.

Track-to-Track:	8 msec. max.
Average:	40 msec. max.
Full-Stroke:	95 msec. max.
Average Latency:	8.33 msec.

1.3 STEP PULSE PERIOD AND SEEK METHOD

The step signal is a 2 μ sec. minimum width pulse which initiates read/write head motion. The step pulse period determines the access method. The number of pulses determines the seek length. The step pulse period must be between 3 μ sec. and 200 μ sec.

Step pulses may be lost at periods greater than 200 μ sec. For additional information on step pulses and seek methods consult the *Seagate ST412 Interface Manual*.

FIGURE 5: Buffered-Seek Timing

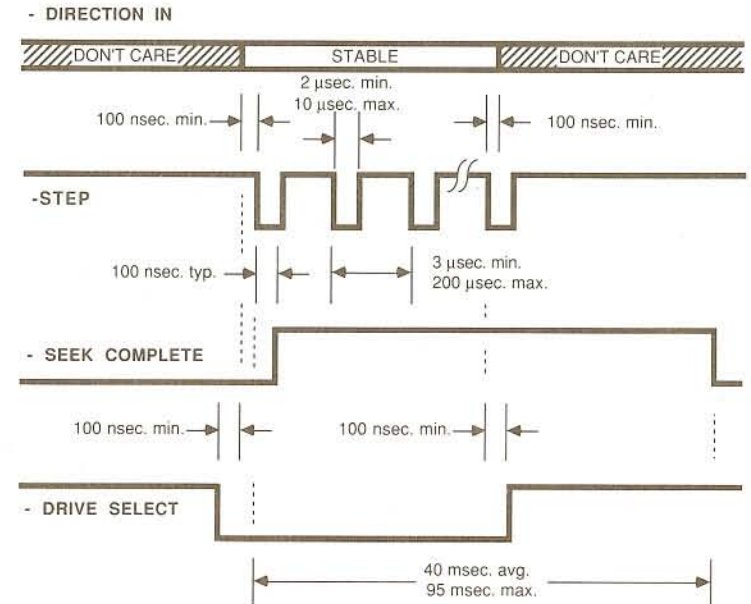
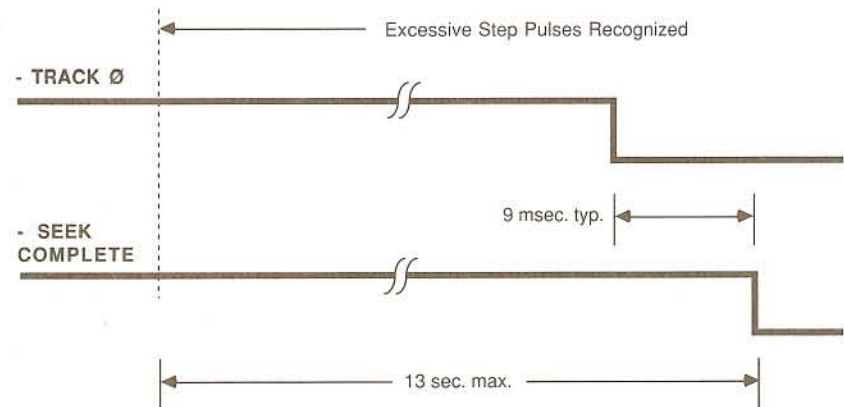

FIGURE 6: Auto-Truncation Timing



1.13 TYPICAL DRIVE TIMING

This section details typical ST251/251R/277R timing. Refer to the *Seagate ST412 Interface Manual* for a general treatment of drive timing.

FIGURE 4: Read/Write Timing

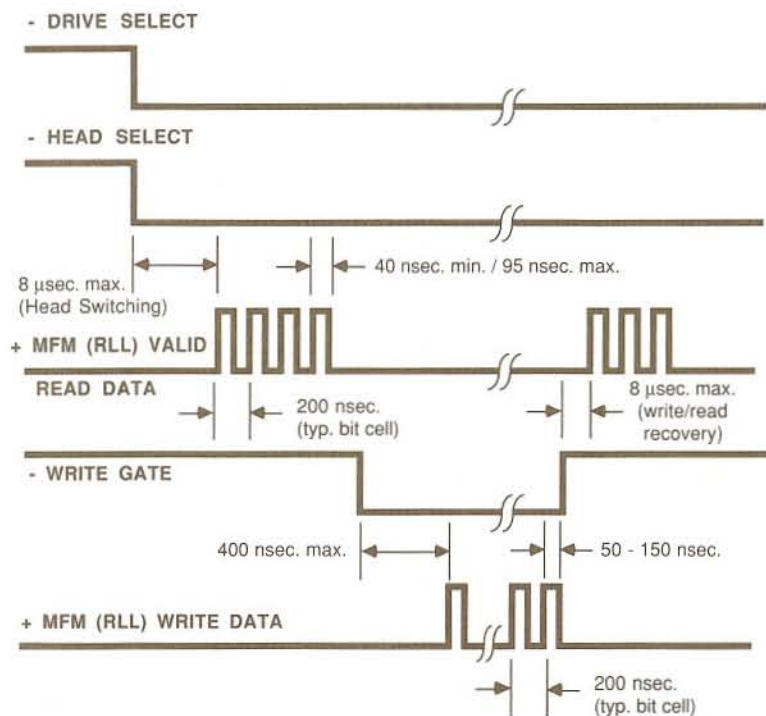

1.4 FUNCTIONAL SPECIFICATIONS

	ST251	ST251R	ST277R
Rotational Speed:	3,600 RPM \pm 0.5%		
Recording Density:	9,935 BPI	14,902 BPI	14,902 BPI
Flux Density:	9,935 FCI	9,935 FCI	9,935 FCI
Track Density:	777 TPI	777 TPI	777 TPI
Interface:	ST412	ST412	ST412
Recording Method:	MFM	RLL (2,7)	RLL (2,7)
Data Transfer Rate:	5.0 Mbits/sec.	7.5 Mbits/sec.	7.5 Mbits/sec.

1.5 RECORDING METHODS

The ST251 is designed to operate with the ST412 interface with MFM encoding at 5.0 megabit/sec. data transfer rate.

Caution: Operation of an MFM drive with an RLL controller is not approved by Seagate.

The ST251R and ST277R are designed to operate with the ST412 interface with Run Length Limited (2,7) encoding at 7.5 megabit/sec. data transfer rate.

1.6 PHYSICAL SPECIFICATIONS

Height:	1.63 inch. max. (41.4 mm)
Width:	5.77 inch. max. (146.1 mm)
Depth:	8.00 inch. max. (203.2 mm)
Weight:	2.75 lbs. (1.25 Kg.)

1.7 RELIABILITY SPECIFICATIONS

MTBF:	20,000 Power-on hours (Sea level, 25°C ambient temp.)
PM:	Not required
MTTR:	30 minutes
Service life:	5 years

1.7.1 READ ERROR RATES

Recoverable Read Errors:	1 per 10^{10} bits read
Nonrecoverable Read Errors:	1 per 10^{12} bits read
Seek Errors:	1 per 10^6 seeks

1.7.1.1 BIT JITTER

Bit jitter reduction determines the relationship between the leading edge of read data and the center of the data window.

The specified read error rates are based on the following bit jitter specifications: the data separator must provide at least -40 dB of bit jitter reduction at 2F with an offset error of less than 1.5 nsec. shift from the center of the data window.

1.7.2 MEDIA DEFECTS

A media defect is a read error when the data, which has been correctly written, cannot be recovered within 16 retries.

A printout will be provided with each drive shipped listing the locations of any defect by head, cylinder, sector and byte. It will also specify the number of bytes from index. For MFM this will be based on 1.6 μ sec./byte. RLL encoding is based on 1.056 μ sec./byte.

A single media defect may be up to 16 bits long. Cylinders 0, 1, 2 and 3 will be free of defects.

1.11.2 HANDLING PRECAUTIONS

After unpacking, and prior to system integration, the drive is exposed to potential handling and ESD hazard.

Do not touch the PCB edge-connectors, board components or the printed circuit cable without observing static-discharge precautions. Handle the drive by the frame only.

Always rest the drive on a padded surface until it is mounted in the host system.

1.11.3 SHIPPING ZONE

Upon power-down, the read/write heads will automatically move to the shipping zone. All portions of the head/slider assembly will park inboard of the maximum data cylinder. When power is applied, the heads will recalibrate to Track 0.

The heads may also be parked in the shipping zone by issuing a seek command to the maximum data cylinder plus one (820).

1.12 AUTO-TRUNCATION

The drive will enter the auto-truncation mode if the controller issues an excessive number of step pulses, which would place the read/write heads outward beyond Track 0 or inward beyond the maximum data cylinder plus one (beyond 820).

With auto-truncation active, the drive will ignore additional pulses, take control of the actuator, and recalibrate the heads to Track 0.

Caution: If the controller is still issuing step pulses after the drive issues Seek Complete from auto-truncation mode, the drive will either reenter auto-truncation mode if Direction-In is false, or step the remaining cylinders if Direction-In is true.

vertical resonant frequency of 25 Hz or lower. A minimum clearance of 0.050 inches should be allowed around the entire perimeter of the drive to allow for cooling airflow and motion during mechanical shock or vibration.

FIGURE 3: Drive Mounting Dimensions

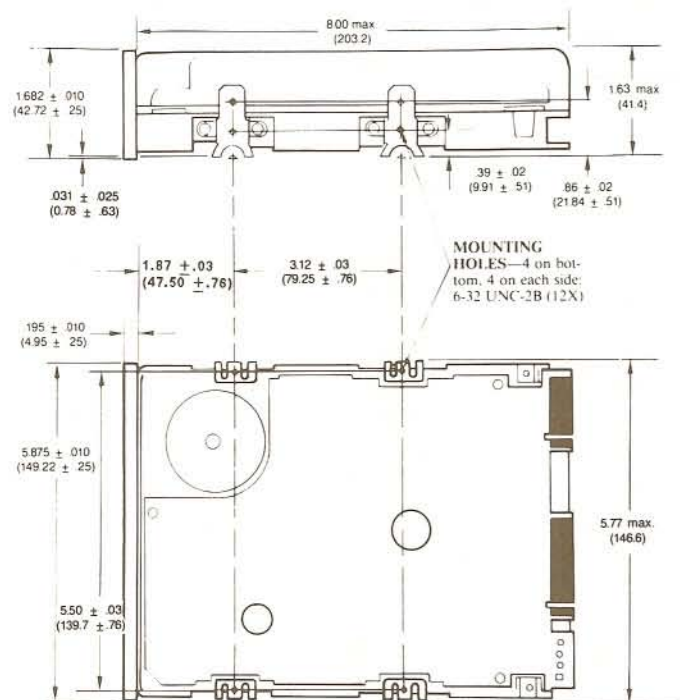

NOTE: The mounting screws must not extend inside the mounting feet more than 0.125 inch, measured from the outside surface of the foot.

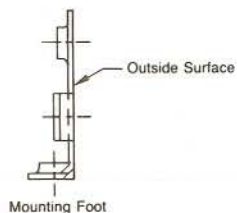

1.7.2.1 ST251

There will be no more than forty-two (42) defects total per drive.

1.7.2.2 ST251R

There will be no more than forty-three (43) defects total per drive.

1.7.2.3 ST277R

There will be no more than sixty-five (65) defects total per drive.

1.8 ENVIRONMENTAL SPECIFICATIONS

1.8.1 AMBIENT TEMPERATURE

1.8.1.1 ST251

Operating: 10°C to 45°C (50°F to 113°F)
 Nonoperating: -40°C to 60° (-40°F to 140°F)

1.8.1.2 ST251R/277R

Operating: 15°C to 45°C (59°F to 113°F)
 Nonoperating: -40°C to 60° (-40°F to 140°F)

1.8.2 TEMPERATURE GRADIENT

Operating: 10°C/hr. (18°F/hr.) max.
 Nonoperating: Below condensation

1.8.3 RELATIVE HUMIDITY

Operating:	8 to 80% noncondensing
Maximum Wet Bulb:	26°C (78.8°F)
Nonoperating:	5 to 90% noncondensing

1.8.4 ALTITUDE LIMITS

Operating:	-1,000 ft to 10,000 ft
Nonoperating:	-1,000 ft to 30,000 ft

1.8.5 SHOCK AND VIBRATION SPECIFICATIONS

All shock and vibration specifications assume that the drive is mounted in an approved orientation with the input levels at the drive mounting screws.

Shock measurements are based on a 11 msec. half-sine wave shock pulse. The nonoperating specifications assume that the read/write heads are positioned in the shipping zone.

1.8.5.1 OPERATING SHOCK

Maximum shock without incurring physical damage or degradation in performance: 10 G's.

1.8.5.2 OPERATING VIBRATION

Maximum vibration, at the following frequencies, without incurring physical damage or degradation in performance:

Freq.	Vibration
5-22 Hz:	0.010 in. Displacement (double amplitude)
22-300 Hz:	0.25 G Acceleration (peak)
300-22 Hz:	0.25 G Acceleration (peak)
22-5 Hz:	0.010 in. Displacement (double amplitude)

It has been type tested and found to comply with the limits for a Class B computing device peripheral in accordance with the specifications in Subpart J of Part 15 of FCC rules, which are designed to provide reasonable protection against such interference in a residential installation. However, there is no guarantee that interference will not occur in a particular installation. If this equipment does cause interference to radio or television, which can be determined by turning the equipment on and off, you are encouraged to try one or more of the following corrective measures:

- Reorient the receiving antenna.
- Move the device to one side or the other of the radio or TV.
- Move the device farther away from the radio or TV.
- Plug the computer into a different outlet so that the receiver and computer are on different branch outlets.

If necessary you should consult your dealer or an experienced radio/television technician for additional suggestions. You may find helpful the following booklet prepared by the Federal Communications Commission: *How to Identify and Resolve Radio-Television Interference Problems*. This booklet is available from the Superintendent of Documents, U.S. Government Printing Office, Washington, DC 20402. Refer to publication number 004-000-00345-4.

1.11 MOUNTING REQUIREMENTS

The drive may be mounted horizontally with the PC Board down or on either side. Mounting vertically on either end is a prohibited orientation. Refer to *Figure 3 on page 1-12* for mounting dimensions.

The drive should not be tilted front or back, in any position, by more than 5°. For optimum performance the drive should be formatted in the same position as it will be mounted in the host system.

1.11.1 SHOCK MOUNTING RECOMMENDATIONS

It is recommended that any external shock mounts between the drive and the host frame be designed so that the composite system has a

1.9.1 INPUT NOISE RIPPLE AND FREQUENCY

The maximum permitted noise ripple is 100 mV (peak-to-peak) measured at the host system power supply across an equivalent 8 Ω resistive load on the +12 Volt line and an equivalent 3 Ω load on the +5 Volt line. The maximum permitted input noise frequency is 20 MHz.

1.9.2 UL/CSA CERTIFICATION

The ST251 is listed in accordance with UL 478 and CSA C22.2 (0-M1982), and meets all applicable sections of IEC 380 and VDE 0806/08.81, as tested by *TUV-Rheinland, North America*.

1.10 FCC CERTIFICATION

WARNING

The ST251 is certified to comply with the limits for a Class B computing device, pursuant to Subpart J of Part 15 of FCC rules. Only devices certified to comply with the Class B limits may be attached to this peripheral. Operation with non-certified devices is likely to result in interference to radio and television reception.

Radio and Television Interference

This equipment generates and uses radio frequency energy and if not installed and used in strict accordance with the manufacturer's instructions, may cause interference to radio and television reception.

1.8.5.3 NONOPERATING SHOCK

Maximum shock without incurring physical damage or degradation in performance: 40 G's.

1.8.5.4 NONOPERATING VIBRATION

Maximum vibration, at the following frequencies, without incurring physical damage or degradation in performance:

Freq.	Vibration
5-22 Hz:	0.020 in. Displacement (double amplitude)
22-300 Hz:	0.50 G Acceleration (peak)
300-22 Hz:	0.50 G Acceleration (peak)
22-5 Hz:	0.020 in. Displacement (double amplitude)

1.9 DC POWER SPECIFICATIONS

Power may be applied or removed in any sequence without loss of data or damage to the drive.

Typical seeking/nonseeking current and power specifications assume nominal voltages applied, 25°C ambient temperature, sea level and spindle rotating.

Typical seek currents are measured on a buffered one-third stroke seek followed by two revolutions of non-seek time.

Maximum (3 sigma max.) seeking/nonseeking current specifications assume 10°C ambient temperature, 5.25 VDC and 12.6 VDC applied, sea level and spindle rotating.

Maximum seek currents are measured on repetitive 3-track buffered seeks with a one-half spindle rotation between each seek.

+ 12 VDC

Voltage Tolerance (inc. ripple): $\pm 5\%$ both seek and nonseek conditions
 Max. Current at Power-Up: 2.0 Amps
 Seeking Current: 1.8 Amps max. Peak
 1.1 Amps max. RMS
 0.7 Amps typ. RMS

Nonseeking Current: 0.7 Amps max. RMS
 0.5 Amps typ. RMS

+ 5 VDC

Voltage Tolerance (inc. ripple): $\pm 5\%$ both seek and nonseek conditions
 Seeking Current: 1.4 Amps max. Peak
 1.1 Amps max. RMS
 0.9 Amps typ. RMS

Nonseeking Current: 1.3 Amps max. RMS
 1.0 Amps typ. RMS

POWER

Seeking: 13 Watts typ.
 Nonseeking: 11 Watts typ.

FIGURE 1: Typical +12 VDC Start-Up Current Profile

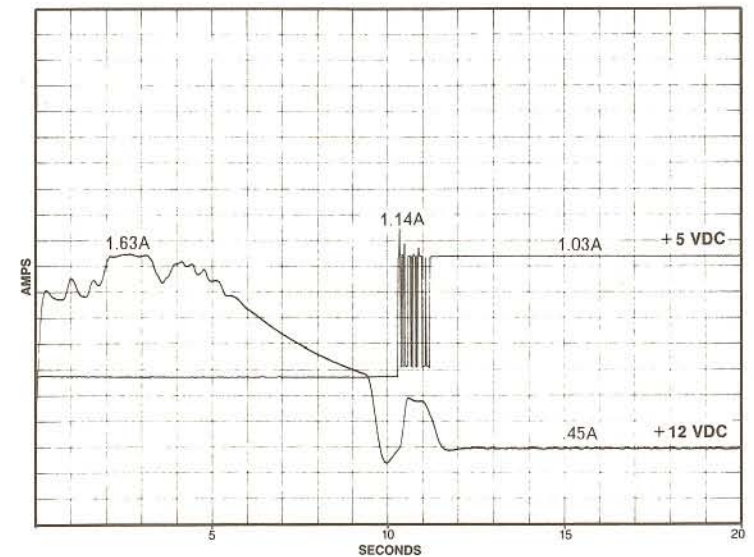

FIGURE 2: Typical Power-On Sequence

